

Hisense

life reimagined

EN

DETAILED INSTRUCTIONS FOR USE OF UPRIGHT REFRIGERATOR AND FREEZER



We thank you for the confidence you have shown by purchasing our appliance which is designed to simplify your life. To make the use of the product easier, we have supplied detailed instructions for use, and installation instructions supplied on a separate sheet. The instructions should allow you to learn about your new appliance as quickly as possible.

We wish you find a lot of pleasure in its use.

The appliance is intended solely for household use.

The refrigerator is intended for storing fresh food at temperatures above 0°C. **The freezer** is intended for freezing fresh food and for long-term storage of frozen food (up to one year, depending on the type of food).

Please visit our website where you can enter your appliance model number, indicated on the rating plate or the warranty sheet, to find detailed description of your appliance, tips on use, troubleshooting, service information, instructions for use etc.

Link to the EU EPREL database

The QR code on the energy label supplied with the appliance provides a web link to the registration of this appliance in the EU EPREL database. Keep the energy label for reference together with the user manual and all other documents provided with this appliance.

It is possible to find information related to the performance of the product in the EU EPREL database using the link <https://eprel.ec.europa.eu> and the model name and product number that you can find on the rating plate of the appliance.

For more detailed information about the energy label, visit www.theenergylabel.eu.



Important safety warning



General information and tips



Protecting the environment



Do not wash in the dishwasher

CONTENTS

4 IMPORTANT NOTES AND PRECAUTIONS 4 BEFORE USING THE APPLIANCE FOR THE FIRST TIME 5 IMPORTANT SAFETY INSTRUCTIONS 8 IMPORTANT INFORMATION ON THE USE OF APPLIANCE 9 ENVIRONMENT PROTECTION 10 ADVICE FOR SAVING POWER WITH REFRIGERATION APPLIANCES	INTRODUCTION
11 INSTALLATION AND CONNECTION 14 REVERSING THE DOOR OPENING DIRECTION 22 APPLIANCE DESCRIPTION 23 OPERATING THE APPLIANCE 27 APPLIANCE INTERIOR EQUIPMENT 30 RECOMMENDED DISTRIBUTION OF FOOD IN THE APPLIANCE	APPLIANCE DESCRIPTION
31 STORING FOOD IN THE REFRIGERATOR 35 FREEZING AND STORING FROZEN FOOD 35 Freezing procedure 36 Important warnings on freezing 36 Storing industrially frozen food 37 Frozen food storage time 37 Defrosting frozen food	STORING AND FREEZING FOOD
38 DEFROSTING THE APPLIANCE 39 CLEANING THE APPLIANCE	DEFROSTING AND CLEANING THE APPLIANCE
40 TROUBLESHOOTING 42 INFORMATION ABOUT APPLIANCE NOISE	MISCELLANEOUS

IMPORTANT NOTES AND PRECAUTIONS

BEFORE USING THE APPLIANCE FOR THE FIRST TIME

Before connecting the appliance to the power mains, please read carefully the instructions for use which describe the appliance and its correct and safe use. The instructions apply to several appliance types/models; thus, settings or equipment may be described herein which is not available in your appliance. We recommend saving this instruction manual for future reference and attach it to the appliance if it is sold in the future.

Check for any damage or irregularities on your appliance. If you find your appliance is damaged, notify the retailer from which you have purchased the appliance.

Before connecting the appliance to the power mains, let the appliance rest in a vertical position for a minimum of 2 hours. This will reduce the possibility of operation faults due to the effect of transport on the cooling system.



IMPORTANT SAFETY INSTRUCTIONS



WARNING! Risk of fire/flammable materials.

The appliance must be connected to the power mains and grounded in compliance with the effective standards and regulations.

WARNING! Do not locate multiple portable socket-outlets or portable power supplies at the rear of the appliance.

Before cleaning the appliance, unplug it from the power mains (unplug the power cord from the wall outlet).

WARNING! If the supply cord is damaged, it must be replaced by the manufacturer, its service agent or similarly qualified persons in order to avoid a hazard.

WARNING! When positioning the appliance, ensure the supply cord is not trapped or damaged.

If LED lighting does not work, call a service technician. Do not attempt a repair of the LED lighting yourself, as there is danger of contact with high voltage!



WARNING! Do not use electrical appliances inside the food storage compartments of the appliance, unless they are of the type recommended by the manufacturer.



WARNING! Do not use mechanical devices or other means to accelerate the defrosting process, other than those recommended by the manufacturer.



WARNING! To avoid any hazard resulting from poor stability of the appliance, make sure it is installed as instructed.

Danger of frostbite

Never put frozen food in your mouth and avoid touching frozen food as this may cause frostnip or frostbite.

Safety of children and vulnerable persons

The appliance is not intended for use by persons (including children) with reduced physical, sensory or mental capabilities, or lack of experience and knowledge, unless they have been given supervision or instruction concerning use of the appliance by a person responsible for their safety.

Children should be supervised to ensure that they do not play with the appliance.

Cleaning and user maintenance shall not be made by children without supervision.

Remove the packaging intended to protect the appliance or particular parts during transport and keep it outside the reach of children.

It presents danger of injury or suffocation.

When removing a used appliance, disconnect the power cord, remove the door, and leave the shelves in the appliance. This will prevent children from locking themselves in the appliance.

For European markets only

This appliance can be used by children aged from 8 years and above and persons with reduced physical, sensory or mental capabilities or lack of experience

and knowledge if they have been given supervision or instruction concerning use of the appliance in a safe way and understand the hazards involved.

Children shall not play with the appliance.

Cleaning and user maintenance shall not be made by children without supervision.

Children aged from 3 to 8 years are allowed to load and unload refrigerating appliances.

Warning regarding the refrigerant

The appliance contains a small amount of an environmentally friendly yet flammable gas R600a.

Make sure that no parts of the cooling system are damaged. A gas leak is not hazardous to the environment, but it could cause eye injury or fire.

In case of a gas leak, ventilate the room thoroughly, disconnect the appliance from the power mains, and call a service technician.

IMPORTANT INFORMATION ON THE USE OF APPLIANCE

WARNING! This appliance is intended to be used in household and similar applications such as:

- staff kitchen areas in shops, offices and other working environments;
- farm houses and by clients in hotels, motels and other residential type environments;
- bed and breakfast type environments;
- catering and similar non-retail applications.

i WARNING! Keep ventilation openings, in the appliance enclosure or in the built-in structure, clear of obstruction.

The appliance may not be used outdoors and it may not be exposed to rain.

Do not store explosive substances such as aerosol cans with a flammable propellant in this appliance.

If the appliance will be out of use for an extended period of time, switch it off using the relevant button, and unplug it from the power mains. Empty the appliance, defrost it, clean it, and leave the door ajar.

In case of an error or power supply failure, do not open the freezer compartment unless the freezer has not operated for over 16 hours. After this period, use the frozen food or provide sufficient cooling (e.g. a replacement appliance).

Technical information on the appliance

Rating plate can be found in the appliance interior. It indicates data on voltage, gross and net volume, type and amount of refrigerant, and information on the climate classes.

If the language on the rating plate is not the language of your choice or the language of your country, replace it with the one supplied.



ENVIRONMENT PROTECTION

Packaging is made of environmentally friendly materials that can be recycled, disposed of, or destroyed without any hazard to the environment.



Removing an obsolete appliance

To protect the environment, take the obsolete appliance to an authorized home appliance collection centre.

Before doing so, do the following:

- disconnect the appliance from the power mains;
- do not allow children to play with the appliance.



WARNING! Do not damage the refrigerant circuit. This will also prevent pollution.



The symbol on the product or its packaging indicates that the product should not be treated as normal household waste. The product should be taken to an authorized collection centre for waste electric and electronic equipment processing. Correct disposal of the product will help prevent any negative effects on the environment and health of people which could occur in case of incorrect product removal. For detailed information on removal and processing of the product, please contact the relevant municipal body in charge of waste management, your waste disposal service, or the store where you bought the product.

ADVICE FOR SAVING POWER WITH REFRIGERATION APPLIANCES

- Install the appliance as specified in the instruction manual.
- Do not open the door more often than necessary.
- Occasionally make sure air circulation underneath the appliance is unobstructed.
- If the gasket is damaged or does not provide a perfect seal for any reason, have it replaced as soon as possible.
- Store the food in tightly sealed containers or appropriate packaging.
- Before placing the food in the refrigerator, allow it to cool down to room temperature.
- Defrost frozen food in the refrigerator compartment.
- To make use of the entire freezer compartment interior volume, remove some of the drawers as described in the instruction manual.
- Defrost your conventional freezer when an approximately 3–5 millimetre layer of frost or ice has built up on the refrigerated surfaces.
- Make sure the layout of shelves in the compartment is uniform and that the food is placed so that the air can freely circulate in the appliance interior (observe the recommended placement of food as described in the instructions).
- In appliances with a fan, do not block the fan slots or vents.
- If you do not need the fan or the ionizer, switch them off to reduce power consumption.

INSTALLATION AND CONNECTION

SELECTING THE ROOM

- Install the appliance in a dry and well ventilated room. The appliance will operate correctly if the environment temperature is in the interval specified in the table. The appliance class is indicated on the rating plate / label with the basic information on the appliance.

Description	Class	Ambient temperature range °C	Relative humidity
Extended temperate	SN	+10 to +32	≤ 75%
Temperate	N	+16 to +32	
Subtropical	ST	+16 to +38	
Tropical	T	+16 to +43	

-  • Do not place an appliance in a room where temperature can drop to below 5 °C as this may cause abnormal appliance operation or failure!
- After the installation, the appliance mains plug should be accessible!
- This appliance is not intended to be used as a build-in appliance.
- Do not place the appliance near appliances or devices radiating heat, such as a cooker, a stove, a radiator, water heater etc., and do not expose it to direct sunlight. The appliance should stand at least 3 cm away from an electric or gas cooker or at least 30 cm away from an oil or solid fuel stove. If the distance between such source of heat and the appliance is smaller, use an insulating panel.

Note: Place the appliance in a sufficiently large room. There should be at least 1 m³ of space per 8 grams of refrigerant. Amount of refrigerant is indicated on the rating plate in the appliance interior.

APPLIANCE PLACEMENT

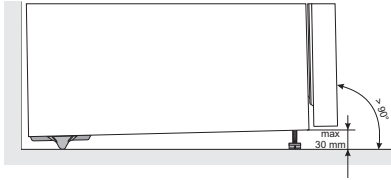

Appliance installation should be carried out by at least two persons to avoid any personal injury or damage to the appliance.

- The appliance must stand level or tilted slightly to the back. It should be stable and placed on a solid base. At the front, the appliance is fitted with two adjustable feet that can be used to level the appliance. At the rear side, casters allow for easier installation of the appliance (only with some models).
 - After you have levelled the appliance using the adjustable feet, adjust the additional foot for extra stability of the appliance.
-
- There should be a clearance of at least 5 cm between the appliance and any cupboard installed above it, in order to allow adequate cooling of the condenser unit.
 - Do not expose the appliance to direct sunlight and do not place it near sources of heat. If this cannot be avoided, install an insulation panel.

- The appliance may be free-standing or it may be placed next to a cupboard, a cabinet or a wall. If you place the appliance next to a cupboard, a cabinet or a wall, its power consumption may increase.
- There has to be a clearance of at least 50 mm between the appliance and any cabinet above it. To allow for adequate ventilation and cooling of the appliance, there has to be sufficient clearance behind the appliance as well (see installation diagram).
- Take into account the space or clearance required to open the appliance door, in order to allow the drawers and shelves to be pulled out or removed (see installation diagram).

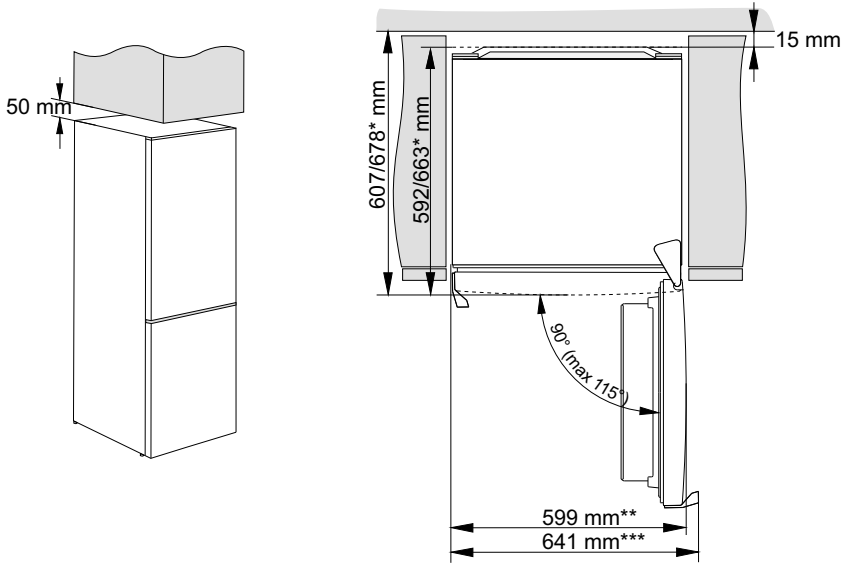

- * depending on the model
- ** model with integrated handle
- *** model with external/protruding handle

CONNECTING THE APPLIANCE

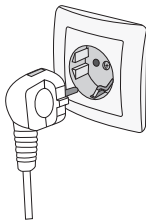

- Connect the appliance to the power mains using the power cord. The wall outlet should be fitted with a ground contact (safety socket). Nominal voltage and frequency are indicated on the rating plate/label with basic information on the appliance.
- The appliance must be connected to the power mains and grounded in compliance with the effective standards and regulations. The appliance will withstand short-term deviations from the nominal voltage, but not more than +/- 6%.

REVERSING THE DOOR OPENING DIRECTION

The direction in which the appliance door opens can be reversed.

Note: Disconnect the appliance from the power mains before reversing the door opening direction.

Tools required:

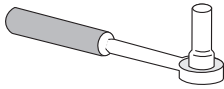

Socket wrench No. 8,



shaped screwdriver

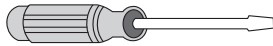

Flat screwdriver



Spanner No. 8

Note:

- If the appliance has to be tilted to allow access to parts on the bottom, ask another person for assistance or gently place the appliance on some soft padding to prevent damaging it. To reverse the opening direction, proceed as follows.

1. Place the appliance in an upright position. Open the top door and remove the door racks (to prevent damaging them during the procedure). Close the door.

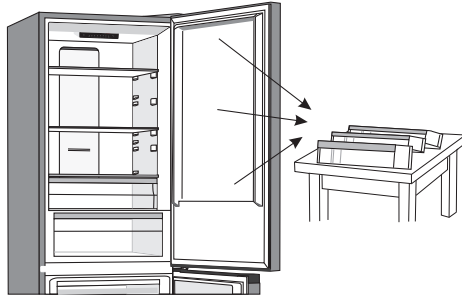

2. Remove the top hinge cap (1).

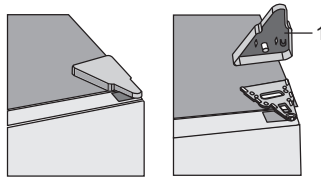

3. Undo the screws (2) and remove the hinge (3). Hold the door while doing this to prevent it from falling.

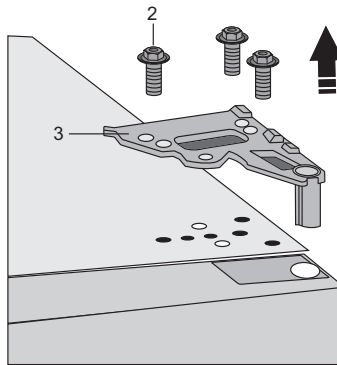

4. Remove the top door from the middle hinge by carefully lifting it straight up. Lay the door onto a smooth surface.

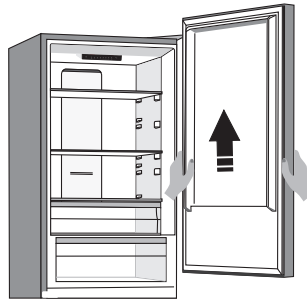

5. Take the (right) cap/cover (4) from the bag and place it on the spot from which the top hinge was removed. Remove and save the cap/cover from the other side (5) to which the hinge will be relocated.

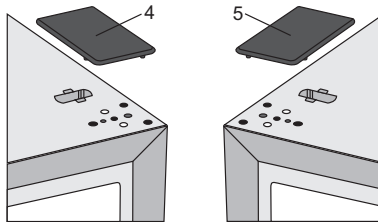

6. Remove the cap (6) from the left side of the top door. Then, remove the cap (7) from the right side of the top door. Place the cap (7) on the left side of the top door and place the cap (6) on the right side of the top door.

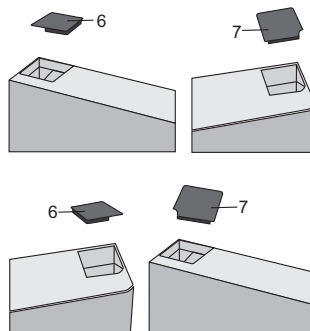

7. Undo the screw (8) and remove the door retainer (10) and the door stop (9). Then, use a screw (8) to install the door retainer supplied in the bag, and the door stop (9).
Keep the door retainer (10) in case you need it later.

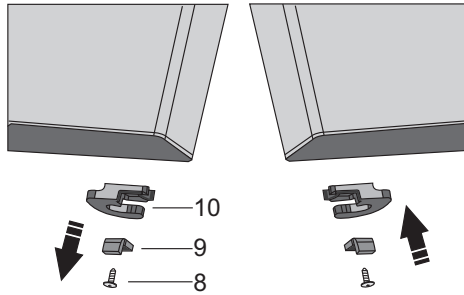

8. Undo the screws from the middle hinge and remove it. Then, remove the bottom door from the bottom hinge.

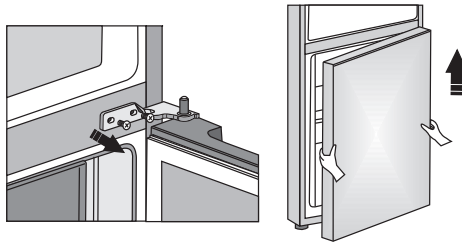

9. Lay the bottom door onto a smooth surface. Undo the screw (8) and remove the door retainer (10) and the door stop (9). Then, use a screw (8) to attach the door retainer supplied in the bag, and the door stop (9). Keep the door retainer (10) in case you need it later.

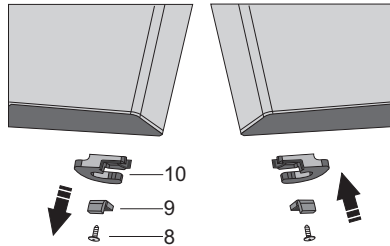

10. Remove the middle hinge cap and replace it on the opposite side.

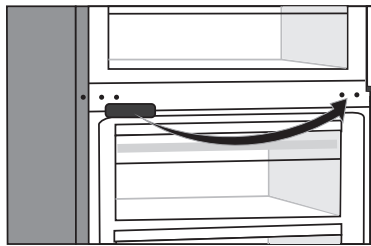

11. Tilt the appliance backwards and remove the adjustable foot (11).
 12. Undo the three screws on the bottom hinge (14) and remove it. Remove the extra foot (12) from the bottom hinge pin (13). Unscrew the pin (13) from the bottom hinge and screw it onto the opposite side of the hinge, complete with the extra foot (12).

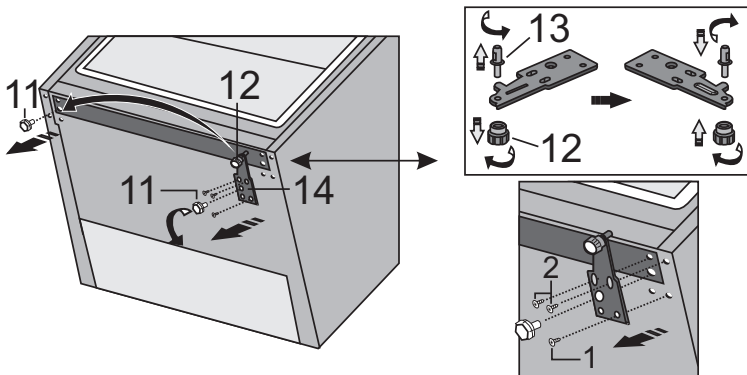

13. Attach the hinge (14) onto the opposite side using the screws. The screws should be attached in the order shown in the figure below. First, tighten the screw 1, followed by screws 2. Then, screw on the adjustable feet (11).

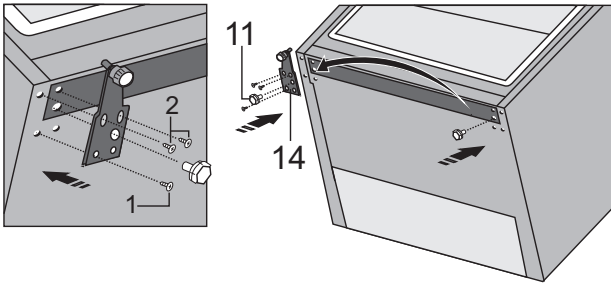

14. Place the bottom door onto the bottom hinge and hold them in place. Rotate the middle hinge by 180°. Place the washer in the correct position and adjust the position of the middle hinge so that you can install and fix the bottom door.

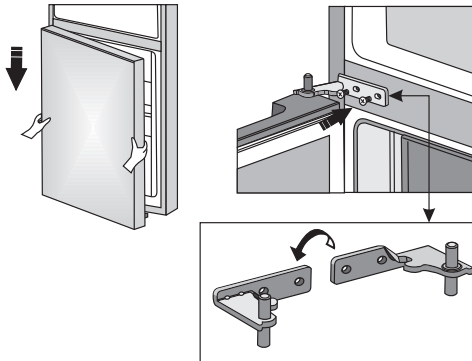

15. Place the top door in the correct position and use the screws (2) to attach the upper hinge (3). Hold the top door in place while positioning them.

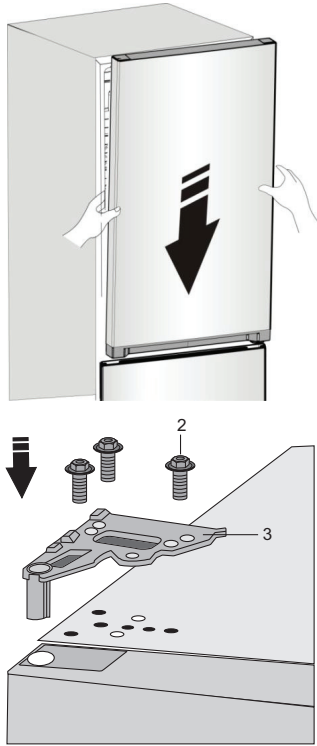

16. Replace the upper hinge cap (1).

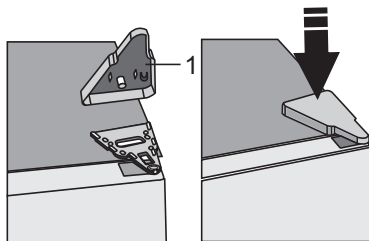

17. Open the top door and replace the door rack; then, close the door.

Note: If your model has a handle, then move it to the opposite side by following the instructions below. Remove the top door and lay them onto a smooth surface. Remove the caps (1) and (4) and undo the screws (2) as shown in the figure. Replace the handle (3) on the opposite side, tighten the screws (2) and replace the caps (1) and (4).

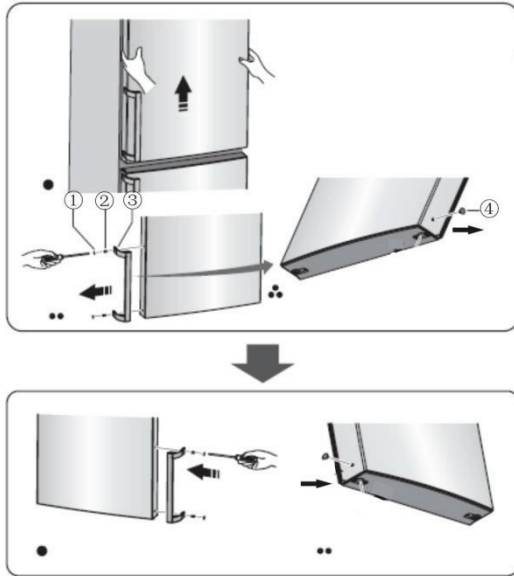

APPLIANCE DESCRIPTION

Appliance interior equipment may change according to the appliance model.

This product contains a light source of energy efficiency class (G).

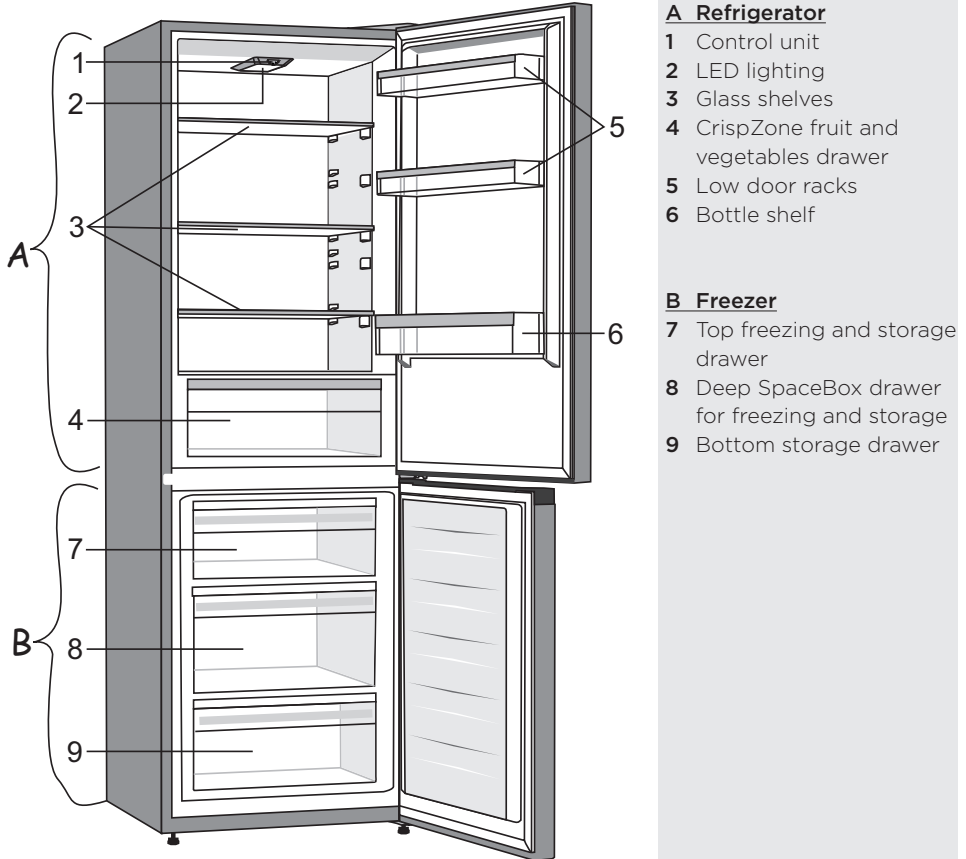

- The drawers are fitted with a system that prevents them from being unintentionally pulled out. To remove a drawer from the appliance, pull it out as far as it will go, then lift at the front and pull out completely.

OPERATING THE APPLIANCE

CONTROL UNIT 1

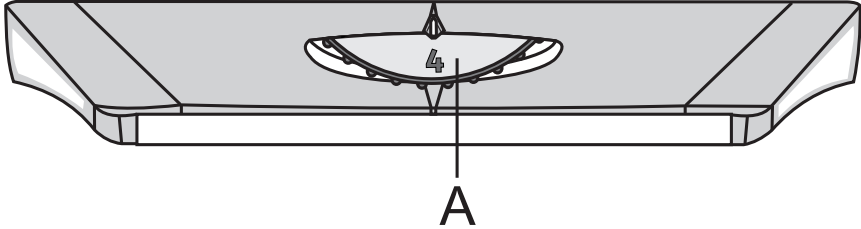

A Appliance on/off and temperature setting dial

SWITCHING THE APPLIANCE ON/OFF

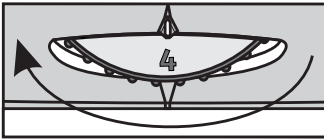

To switch on the appliance, rotate the dial to the left and select a setting between **1** and **7**.

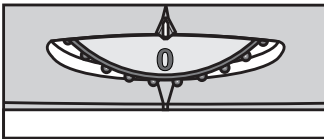

To switch off the appliance, rotate the dial to position **0** (caution: the appliance is still powered).

ADJUSTING THE TEMPERATURE IN THE APPLIANCE

- i** • After the appliance is switched on, it may take several hours for the set temperature to be reached. Do not place any food into the refrigerator before the temperature drops to the selected setting.

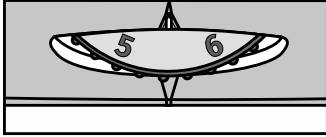

- To set the desired temperature, rotate the **A** dial to the left or right to select the desired setting.
- Recommended setting of the **A** knob is between positions **5** and **6**.
- A change in the environment temperature will affect the temperature in the appliance. Adjust the temperature setting with the **A** dial accordingly. Settings closer to **7** correspond to lower temperature in the appliance (cooler), while settings closer to **1** correspond to higher temperature (warmer).

If the temperature of the room where the appliance is installed is below 16 °C, we recommend setting the **A** dial to approximately **6**.

- i** • If you set the dial to **7**, there is a possibility that the temperature in the refrigerator compartment will drop to below 0 °C.

CONTROL UNIT 2

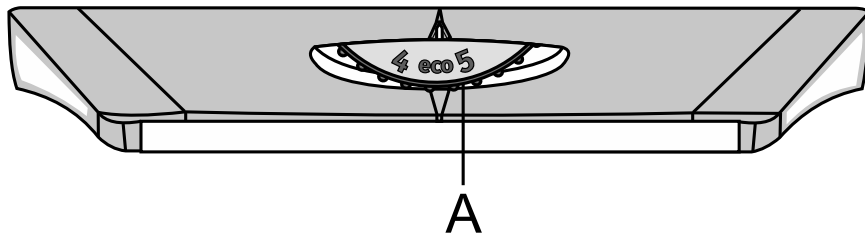

A Appliance on/off and temperature setting dial

SWITCHING THE APPLIANCE ON/OFF



To switch on the appliance, rotate the dial to the left and select a setting between **1** and **7**.

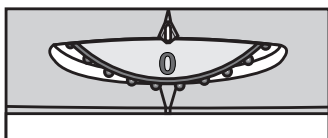

To switch off the appliance, rotate the dial to position **0** (caution: the appliance is still powered).

ADJUSTING THE TEMPERATURE IN THE APPLIANCE



- After the appliance is switched on, it may take several hours for the set temperature to be reached. Do not place any food into the refrigerator before the temperature drops to the selected setting.



- To set the desired temperature, rotate the **A** dial to the left or right to select the desired setting.
- Recommended setting of the **A** knob is on the **eco** position.
- A change in the environment temperature will affect the

temperature in the appliance. Adjust the temperature setting with the **A** dial accordingly. Settings closer to **7** correspond to lower temperature in the appliance (cooler), while settings closer to **1** correspond to higher temperature (warmer).

If the temperature of the room where the appliance is installed is below 16 °C, we recommend setting the **A** dial to approximately **6**.

-  • If you set the dial to **7**, there is a possibility that the temperature in the refrigerator compartment will drop to below 0 °C.

FREEZER BOOST (SUPER FREEZE) FUNCTION

- Use this setting after switching on the appliance for the first time, before cleaning, or 24 hours before inserting a large amount of food.

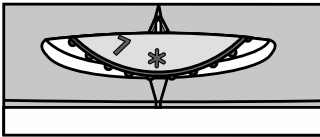

Switching on the freezer boost (super freeze) function:

Rotate the **A** dial to position *****.

-  • When the intensive freezing function is activated, temperature may be lower both in the refrigerator and the freezer compartment.

After the end of the freezer boost cycle, rotate the **A** knob back to the desired setting.

If the freezer boost is not deactivated manually, it will be automatically switched off after approximately 2 days. Then the temperature of the freezer compartment returns to the most recently set value (knob position remains at *****).

APPLIANCE INTERIOR EQUIPMENT

(* EQUIPMENT DEPENDS ON THE MODEL)

SHELF

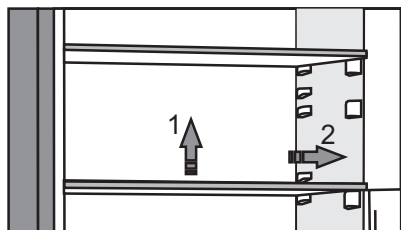

- You can lay out the empty shelves to your liking across the guides in the refrigerator interior without having to remove them from the refrigerator. To move the shelf or take it out from the refrigerator, slightly lift it at the back, pull it towards you, and then either move it or take it out of the appliance.

Store quickly perishable food at the back of the shelf where the temperature is the lowest.

WIRE BOTTLE RACK*

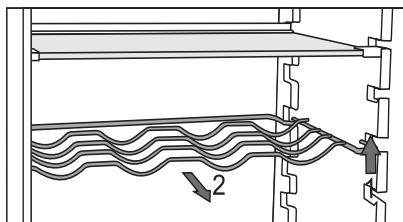

- Some models also feature a wire bottle rack. It is protected against being inadvertently pulled out. It can only be pulled out when it is empty. To pull it out, lift it slightly at the back and pull it towards you. Place the bottle rack so that the length of the bottles does not hinder proper closing of the door.

The holder can take a maximum load of nine 0.75-litre bottles or 13 kilograms of total weight - see label on the right side in the appliance interior.

- Cans may also be placed on the bottle rack (lengthwise or crosswise).

FRUIT AND VEGETABLE BIN



- The bin at the bottom of the refrigerator is intended for storing fruit and vegetables. It provides humidity and prevents the food from drying out.

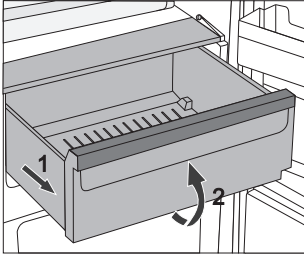

- Pulling out the bin:
 - Pull out the bin as far as it will go. Then, lift the front part and pull it out completely.



DOOR RACKS

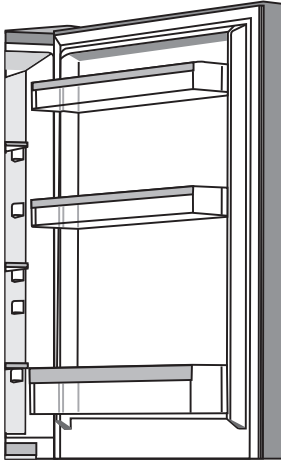

Interior side of the refrigerator door is fitted with racks intended for storing cheese, butter, eggs, yoghurt, and other smaller packages, tubes, cans etc.

You may lay out the racks as desired by lifting them slightly from the grooves that hold them in place and moving them to the desired spot, making sure to fit them in the grooves there.

The bottom rack is intended for storing bottles.

Maximum load on each door rack is 5 kg.

FAN WITH AIR IONIZER (IonAir)*

- Advanced fan system with dynamic cooling evenly distributes the ionized air and equalizes the temperature throughout the entire refrigerator. Air enriched with extra negative ions mimics the natural microclimate that keeps the food fresh for longer. This system also allows placing any type of food on any shelf in the fridge, as there are not temperature differences between them.
- It is activated automatically when there is need for more intensive cooling.

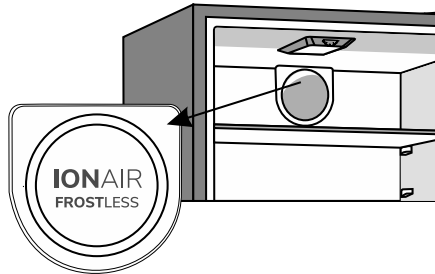

RECOMMENDED DISTRIBUTION OF FOOD IN THE APPLIANCE

Sections in the refrigerator compartment:

- **upper part:** canned food, bread, wine, pastry etc.
- **middle part:** dairy products, ready-made meals, desserts, soft drinks, beer, cooked food, etc.
- **Fruit and vegetable bin:** fresh fruit, vegetables, salads, root vegetables, potatoes, onions, garlic, tomatoes, sauerkraut, turnips etc.



Sections in the refrigerator compartment door:

- **upper/middle door bins:** eggs, butter, cheese etc.
- **lower door bins:** beverages, cans, bottles

i **Do not store** fruit (bananas, pineapples, papaya, citruses) and vegetables (zucchini, eggplant, cucumbers, bell peppers, tomatoes, and potatoes) sensitive to low temperatures in the refrigerator.

Freezer sections:

- freezing, storing frozen food (see chapter Freezing and storing frozen food).

i **Do not store the following in the freezer:** lettuce, eggs, apples, pears, grapes, peaches, yoghurt, soured milk, sour cream, and mayonnaise.

STORING FOOD IN THE REFRIGERATOR

IMPORTANT WARNINGS REGARDING FOOD STORAGE



Correct use of the appliance, appropriate packaging, maintaining the right temperature, and observing the food hygiene standards have a decisive impact on the quality of food storage.

Observe the expiry dates for the food, indicated on the packaging.

Food stored in the refrigerator should be kept in closed containers or in appropriate packaging to prevent it from emitting or receiving odours and humidity.

Do not store inflammable, volatile, and explosive substances in the refrigerator.

Bottles with high alcohol content should be tightly sealed and stored in an upright position.

Some organic solutions, essential oils in lemon and orange peel, butter acid, etc. may damage the plastic surfaces in case of a prolonged contact, causing damage and premature ageing of these materials.

Unpleasant odour warns of lacking cleanliness of the appliance or perished contents (see chapter Cleaning the Appliance).

If you are leaving home for a longer period of time, remove perishables from the refrigerator.

AVOID CONTAMINATION OF FOOD

To avoid contamination of food, please respect the following instructions:

- Opening the door for long periods can cause a significant increase of the temperature in the compartments of the appliance.
- Regularly clean surfaces that can come in contact with food and accessible drainage systems.
- Store raw meat and fish in suitable containers in the refrigerator, so that it is not in contact with or drip onto other food.
- If the refrigerating appliance is left empty for long periods, switch off, defrost, clean, dry, and leave the door open to prevent mould developing within the appliance.

STORING FOOD*

TYPE OF FOOD	Optimum storage temperature (°C)	Optimum storage humidity level (%)	Approximate storage time
Pork	-1 to 4	95	3 days
Beef	0 to 4	95	up to 3 weeks
Lamb	0 to 4	95	14 days
Chicken	0 to 4	95	3 days
Fish	0 to 4	95	3 to 10 days
Mollusc	0 to 4	95	2 days
Wet-aged beef	1,5	95	16 weeks
Dairy products (yoghurt, sour cream, butter, soft cheese, cheese spreads etc.)	2 to 4	95	7 to 10 days
Beetroot	0	95	3 to 5 months
Broccoli	0	95-100	10 to 14 days
Cabbage, young	0	98-100	3 to 6 weeks
Carrots, ripe	0	98-100	4 to 5 months
Lettuce, winter	0	95-100	2 to 3 weeks
Garlic	0	65-70	6 to 7 months
Kohlrabi	0	98-100	2 to 3 months
Brussels sprouts	0	90-95	3 to 5 weeks
Cabbage, Chinese	0	95-100	2 to 3 months
Cabbage, late varieties	0	98-100	3 to 4 months
Carrots	0	95-100	2 weeks
Cauliflower	0	95-98	2 to 4 weeks
Celery, regular	0	98-100	2 to 3 months
Swiss chard	0	95-100	10 to 14 days
Radicchio	0	95-100	2 to 4 weeks
Corn, sweet	0	95-98	5 to 8 days

TYPE OF FOOD	Optimum storage temperature (°C)	Optimum storage humidity level (%)	Approximate storage time
Leeks	0	95-100	2 to 3 months
Mushrooms	0	95	3 to 4 days
Parsley	0	95-100	2 to 3 days
Parsnip	0	98-100	4 to 6 months
Radish, winter	0	95-100	2 to 4 months
Horseradish	0	98-100	10 to 12 months
Cauliflower	0 to 2	90-95	2 to 4 weeks
Onions	0 to 2	65-70	6 to 7 months
Asparagus	0 to 2	95-100	2 to 3 weeks
Peas, green	0 to 2	95-98	1 to 2 weeks
Vegetables, chopped	0 to 2	90-95	up to 5 days
Brussels sprout	0 to 2	90-95	1 to 2 weeks
Gooseberries	0 to 2	90-95	3 to 4 weeks
Cucumbers	4 to 10	95	10 to 14 days
Potatoes	7 to 10	90-95	up to 9 months
Avocado, unripe	7 to 10	85-95	up to 6 weeks
Bell peppers	7 to 10	90-95	2 to 3 weeks
Tomatoes	10 to 12	85-90	4 to 7 days
Beans, seeds	< 15	40-50	6 to 10 months
Pears	-3	90-95	2 to 7 months
Apricots	-1	90-95	1 to 3 weeks
Strawberries	0	90-95	3 to 7 days
Raspberries	0 to 2	90-95	2 to 3 days
Currants	0 to 2	90-95	1 to 4 weeks
Blueberries	0 to 2	90-95	14 days
Cherries	0 to 2	90-95	2 to 3 weeks
Grapes	0 to 2	85	2 to 8 weeks
Kiwi, ripe	0 to 2	90-95	1 to 3 months
Peaches	0 to 2	90-95	2 to 4 weeks

TYPE OF FOOD	Optimum storage temperature (°C)	Optimum storage humidity level (%)	Approximate storage time
Cherries	0 to 2	90-95	2 to 3 weeks
Kiwi, unripe	0 to 2	90-95	2 to 6 months
Nectarines	0 to 2	90-95	1 to 3 weeks
Oranges	0 to 2	90-95	2 to 4 weeks
Persimmon	0 to 2	90-95	2 to 3 months
Plums	0 to 2	90-95	2 to 5 weeks
Fruit, chopped	0 to 2	90-95	up to 10 days
Apples	0 to 4	90-95	1 to 12 months
Melons	4	90-95	15 days
Oranges	4 to 7	90-95	2 to 4 weeks
Tangerines	5 to 8	90-95	2 to 4 weeks
Mango	10 to 13	85-95	2 to 3 weeks
Melons	10 to 13	85-95	1 to 2 weeks
Pineapples	10 to 13	85-95	2 to 4 weeks
Lemons	11 to 13	90-95	2 to 3 weeks
Watermelon	12 to 15	85-95	1 to 3 weeks
Bananas, ripe	13 to 16	85-95	3 days
Grapefruit	13 to 16	90-95	1 to 3 weeks

FREEZING AND STORING FROZEN FOOD

FREEZING PROCEDURE



Maximum amount of fresh food that may be inserted at once is specified on the appliance rating plate. If the amount of food to be frozen exceeds the indicated amount, the quality of freezing will be inferior; in addition, the quality of the food already frozen will deteriorate.

- To make use of the entire freezer volume, remove all drawers.
- Activate the super freeze function 24 hours before freezing fresh food:
 - **Control unit 1:** rotate the **A** dial towards **6**;
 - **Control unit 2:** rotate the **A** dial to position *****.

To make sure the food freezes as quickly as possible, lay out the packages as described below:

- Divide fresh food into smaller packages (1 kg). Lay out the packages along the drawer walls, making sure the packages are not in contact (and that they are as spaced as far apart as possible) and that the fresh packages are not placed one above the other, even if they are in different drawers. Place the most packages in the upper drawer, and distribute the rest evenly between the middle and lower drawer.

Make sure the fresh food is not in contact with the food that is already frozen.

IMPORTANT WARNINGS ON FREEZING



Only use the freezer to freeze food appropriate for freezing. Always use quality and fresh food.

Select the most suitable packaging for the food and use the packaging correctly.

Make sure the packaging is air and water tight so that the food does not dry out and lose its vitamins.

Indicate the type of food, amount, and date of freezing on the packaging.

It is important that the food freezes quickly. Therefore, smaller packages are recommended. Refrigerate the food before freezing.

STORING INDUSTRIALLY FROZEN FOOD

- When storing and using frozen food, observe the manufacturer's instructions. Temperature and expiry date are indicated on the packaging.
- Only choose food with undamaged packaging, stored in freezers at temperatures of $-18\text{ }^{\circ}\text{C}$ or lower.
- Do not purchase food covered in frost as this indicates it has been partly thawed several times and that it is of inferior quality.
- Protect the food from thawing during transport. In case of an increase in temperature, storage time will be shorter and quality will deteriorate.

FROZEN FOOD STORAGE TIME

RECOMMENDED STORAGE TIME IN THE FREEZER

Type of food	Time
fruit, beef	from 10 to 12 months
vegetables, veal, poultry	from 8 to 10 months
Venison	from 6 to 8 months
Pork	from 4 to 6 months
finely chopped or ground meat	4 months
bread, pastry, cooked meals, lean fish	3 months
entrails	2 months
smoked sausage, fatty fish	1 month

DEFROSTING FROZEN FOOD

- Defrosting is an important step when storing frozen food. The food has to be defrosted correctly.
- Following are suitable defrosting methods:
 - in the refrigerator,
 - in cold water,
 - in a microwave oven or a convection oven with a suitable defrosting program.
- Some frozen products can be cooked without prior defrosting. This will be specified by the manufacturer on the packaging.
- Pack the food in small amounts. This will allow the food to defrost quicker.
- Use partly or completely defrosted food as soon as possible. Bacteria in defrosted food is reactivated and the food will spoil fast. This applies particularly to fruit, vegetables, and ready-made food.
- Do not re-freeze food that has been partly or completely defrosted.

DEFROSTING THE APPLIANCE

AUTOMATIC REFRIGERATOR DEFROSTING

Refrigerator does not need defrosting because the ice on the back interior wall is thawed automatically.

Any accumulated ice will melt when the compressor unit is inactive. Drops will flow through an opening in the refrigerator rear wall into a tray fitted above the compressor, from where they will evaporate.

Make sure the opening in the back wall in the refrigerator interior is never blocked by food or any other object.

If an excessive layer of ice is formed on the rear wall of refrigerator interior (3-5 mm), switch off the appliance and defrost the appliance manually.

DEFROSTING A CONVENTIONAL FREEZER

- Defrost the freezer when an approximately 3-5 millimetre layer of frost or ice has built up.
- 24 hours before defrosting, activate the super freeze function to additionally cool the food (see section Freezing procedure).

After this period, remove the food from the freezer and protect them from defrosting.

- Switch off the appliance (see chapter Switching the appliance on/off) and unplug the power cord.
- Do not use a knife or any other sharp object to remove the frost, as you may damage the cooling system.
- To speed up the defrosting process, place a pot of hot water on the glass shelf.
- Clean and dry the appliance interior (see chapter Cleaning the Appliance).

CLEANING THE APPLIANCE



Before cleaning, unplug the appliance from the power mains – switch off the appliance (see chapter Switching the Appliance On/Off) and unplug the power cord from the wall outlet.

- Use a soft cloth to clean all surfaces. Cleaners that contain abrasive substances, acids, or solvents are not suitable for cleaning as they may damage the surface.

Clean the appliance **exterior** with water or a mild solution of suds. Lacquer-coated and aluminium surfaces may be cleaned with lukewarm water to which you have added a mild detergent. Use of cleaners with low alcohol content is allowed (e.g. window cleaners). Do not use cleaners containing alcohol for cleaning plastic materials.



Appliance **interior** can be cleaned with lukewarm water to which you can add some vinegar.



- Do not wash the parts of appliance interior equipment in a dishwasher as they may be damaged.

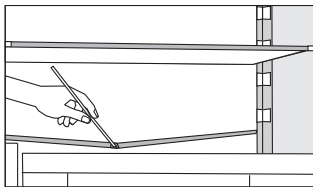

- A gutter and an opening for discharging the water from thawed frost deposits are located underneath the cooling panel that cools the refrigerator interior. The gutter and the opening may not be clogged. Inspect them often and clean if necessary (e.g. with a plastic straw).
- Frost or ice build-up, 3-5 mm thick, will increase power consumption. Therefore, it should be regularly removed. Do not use any sharp objects, solvents, or sprays.
- After cleaning, switch the appliance back on and insert the food.

TROUBLESHOOTING

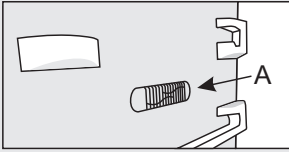
Problem:	Cause or remedy:
Appliance is connected to the power mains but it does not work.	<ul style="list-style-type: none"> • Make sure there is voltage in the power outlet and that the appliance is switched on.
Cooling system operates continuously for a long period of time: 	<ul style="list-style-type: none"> • Too high environment temperature. • Door opened too frequently or too long. • Door not closed correctly (possible impurities on the seal, misaligned door, damaged seal etc.). • Too much fresh food inserted at once. • Sensor in the refrigerator (A) blocked by fresh food. Make sure the air can circulate around the sensor (only with some models).
Excessive build-up of ice on the back wall of refrigerator interior can be a result of the following:	<ul style="list-style-type: none"> • Door opened too frequently or too long. • Warm food placed in the refrigerator. • Food or containers in contact with the back interior wall of the refrigerator. • Poor door sealing. • If the seal is dirty or damaged, clean or replace it.
Build-up of ice or frost in the freezer interior:	<ul style="list-style-type: none"> • Freezer compartment has not been defrosted for a while (or regularly). Defrost the freezer compartment to remove the ice. • The door is not properly closed. • The door has a poor seal (the gasket is dirty, the door is not properly aligned, the gasket is damaged etc.).
Condensate (dew) on the shelf above the drawers:	<ul style="list-style-type: none"> • This is transient phenomenon which cannot be entirely avoided in periods of high environment temperature and humidity. It subsides when temperature and humidity are normalized. We recommend cleaning the drawers more frequently and wiping the droplets occasionally. • Open the humidity control slider. • Put food in bags or other packaging with a good seal.

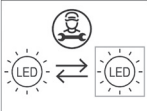
Problem:	Cause or remedy:
Droplets on the refrigerator compartment back wall.	<ul style="list-style-type: none"> • This is normal. The refrigerator compartment is defrosted automatically, which results in droplets of water that flows through an opening in the refrigerator compartment back wall into a tray above the compressor unit, from which it evaporates.
Water is dripping/leaking from the refrigerator:	<ul style="list-style-type: none"> • Clogged water discharge opening or water dripping past the water gutter. • Clean the blocked opening, e.g. using a plastic straw. • If a thick layer of ice builds up, defrost the appliance manually (see Defrosting the Appliance).
Door is difficult to open:	<ul style="list-style-type: none"> • If you are trying to open the freezer door after just having closed it, this could be difficult to do. As you open the door, some cool air escapes from the appliance and it is replaced by warm air from the environment. When this air is cooled, negative pressure is generated which results in problems as you try to open the door. After a few minutes, the condition is normalized and the door can be easily opened again.
Appliance sides are warm.	<ul style="list-style-type: none"> • This is normal. There are pipes and tubes installed in the appliance sides, which tend to heat up during appliance operation.
LED lighting does not work: 	<ul style="list-style-type: none"> • If LED lighting does not work, call a service technician. • Do not attempt a repair of the LED lighting yourself, as there is danger of contact with high voltage!

If the above tips do not resolve your problem, call the nearest authorized service centre and state the type, model, and serial number indicated on the appliance rating plate or label located in the appliance interior.

INFORMATION ABOUT APPLIANCE NOISE

Cooling in refrigerator freezers is made possible by a cooling system that also includes a compressor (and a fan with some appliances), which generates some noise. The level of noise depends on installation, proper use, and age of the appliance.

- After connecting the appliance to the power mains, compressor operation, or the sound of flowing liquid, may be somewhat louder. This is not a sign of malfunction and it will not affect the useful life of the appliance. In time, appliance operation and this noise will become quieter.
- Sometimes, unusual or loud noises may appear during appliance operation; these are mostly the result of improper installation:
 - The appliance must stand level and stable on a solid base.
 - The appliance may not be in contact with a wall or adjacent furniture.
 - Make sure the interior equipment sits firmly in its place and that the noise is not caused by rattling cans, bottles or other containers placed next to each other.
- Due to the higher workload on the cooling system when the door is opened more frequently or for a longer time, when a large amount of fresh food is introduced or when intensive freezing or cooling functions are activated, the appliance can temporarily generate more noise.

WE RESERVE THE RIGHT TO CHANGES THAT DO NOT AFFECT THE APPLIANCE FUNCTIONALITY.

Hisense UK Ltd

Unit 2 Meadow Court Millshaw Lane Leeds, West Yorkshire, LS11 8LZ,
United Kingdom

Hisense France SAS

9 Rue des 3 Sœurs, 93420 Villepinte, France

Hisense Germany GmbH

Garmischer Strasse 4-6, 80339 München, Germany

Hisense Italia SRL

Via Montefeltro, 6/A 20156 Milano, Italia

Hisense Iberia S.L

Ronda Auguste y Louis Lumiere, 23 Nave 12
Edificio Lumiere – Parque Tecnológico 46980 Paterna (Valencia). España

Gorenje gospodinjski aparati, d.o.o.

Partizanska cesta 12, 3320 Velenje, Slovenia

Hisense

COMBI FS600-20 ESS HSN



822993

en (05-23)