

ASKO



Instructions for use

Coffee machine

CM8477x

Pictograms used



Important information



Tip

CONTENTS

Your coffee machine

Introduction	4
Description of the appliance	5
Touch keys and symbols	8

Operation

Before first use	10
Set your appliance to 'On'	12
Set your appliance to 'Standby' and 'Off'	12
Important tips and tricks when you make coffee	13
Make coffee using coffee beans	13
Make coffee using pre-ground coffee	14
Adjust the grind level	14
Make milk-based hot drinks	15
Make two cups of coffee	15
Customise beverages	16
Supply a beverage that is customised	16
Customise a user profile	17
Supply hot water or steam	17

Settings

Settings menu	18
---------------	----

Maintenance

Clean your appliance	20
Clean the hot water spout	21
Clean the internal tubes of the milk container and the nozzle	21
Clean all components of the milk container	22
Clean the appliance's internal circuit	23
Clean the coffee grounds container	23
Clean the drip tray	24
Clean the inside of the coffee machine	24
Clean the water tank	25
Clean the coffee spouts	25
Clean the pre-ground coffee funnel	25
Descalcify the appliance	26
Set the water hardness	28
Install a water softener filter	28
Replace a water softener filter	29
Remove a water softener filter	29
Clean the brewing unit / infuser once a month	30
Clean the brewing unit / infuser twice a year	31
Use the milk cleaner	34

Trouble shooting

Trouble shooting	36
------------------	----

Environmental aspects

Disposal of packaging and appliance	38
-------------------------------------	----

YOUR COFFEE MACHINE

Introduction

Congratulations on your choice of this Asko coffee machine. This product was designed with simple operation and optimum comfort in mind.

This manual describes the best way to use this coffee machine. In addition to information on operation, you will also find background information that may come in handy when using the appliance.



Please read the separate safety instructions carefully before using the appliance!

Read this manual before using the appliance and keep it in a safe place for future use.

Installation instructions are supplied separately.

YOUR COFFEE MACHINE

Description of the appliance

Control panel

- A. My profile
- B. Settings
- C. User profile
- D. Selected aroma
- E. Time
- F. Selected size
- G. Aroma
- H. Size
- I. Scroll left/right
- J. Beverages available to select

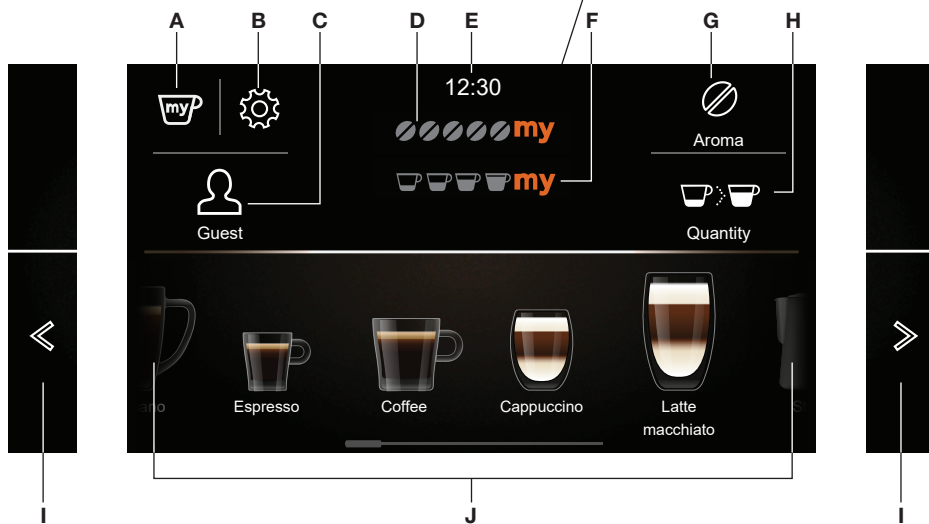

When this primary screen is shown, the appliance is ready to use.

Beverages available to select



YOUR COFFEE MACHINE

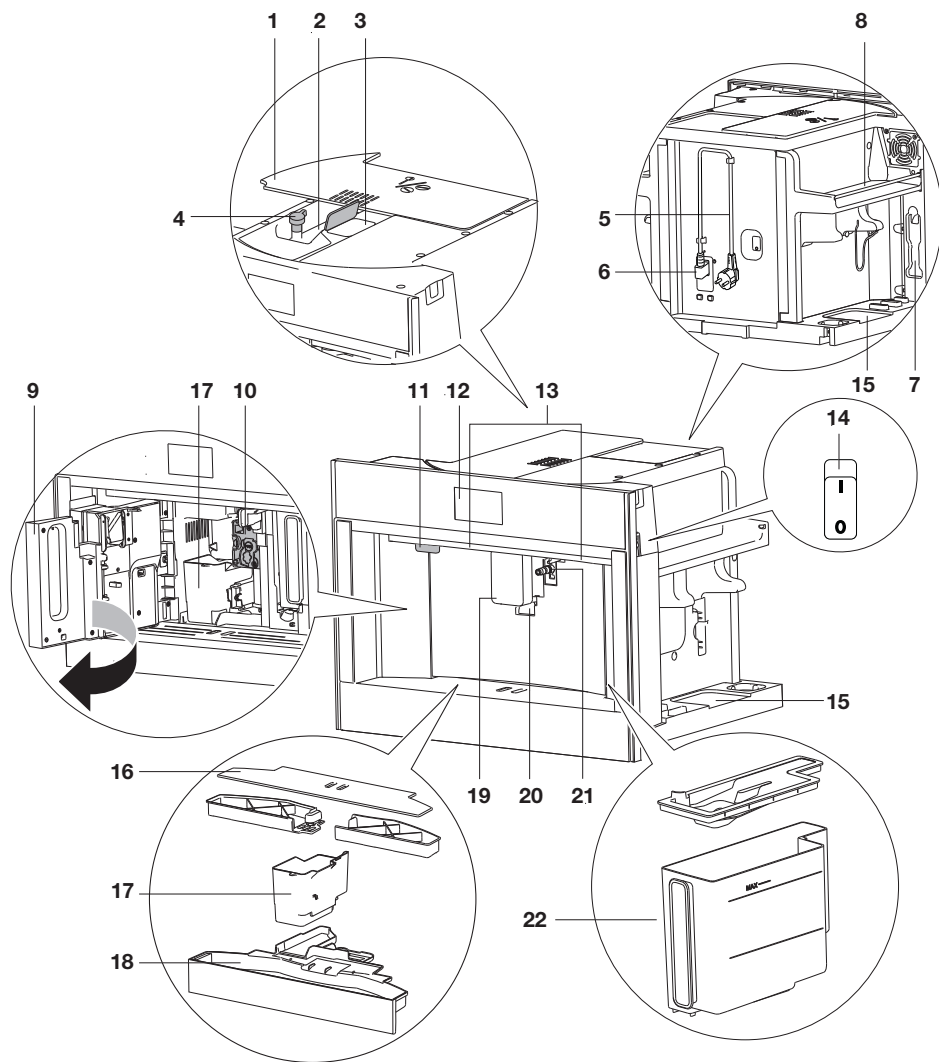

YOUR COFFEE MACHINE

1. Lid bean container
2. Bean container
3. Ground coffee funnel (with lid)
4. Knob to adjust the grind level
5. Power cord
6. IEC connector
7. Area for the measuring spoon
8. Cup warming area
9. Service door
10. Brewing unit
11. On/Standby button
12. Control panel
13. Lighting
14. Main switch
15. Area for accessories (left and right)
16. Cup tray
17. Coffee grounds container
18. Drip tray with level indicator
19. Coffee spouts (adjustable height)
20. Cup lights
21. Hot water connection nozzle
22. Water tank
23. Hot water spout
24. Cover connection nozzle
25. Lid with milk frother
26. Frothed milk spout (adjustable)
27. Milk froth adjustment knob
28. Milk intake tube
29. Release button
30. Milk container
31. Thermal casing
32. Measuring spoon for pre-ground coffee

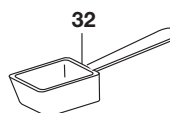
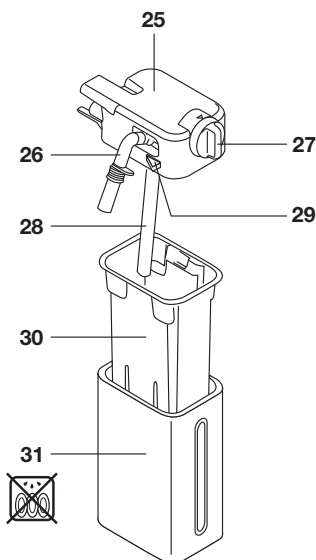
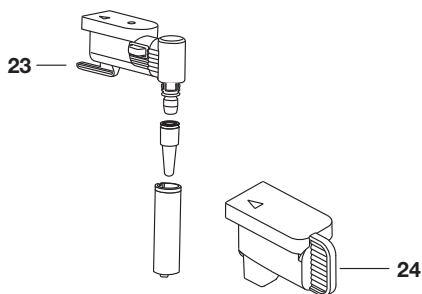













Maintenance set





- 'Total Hardness Test' indicator paper
- Descaler
- Water softener filter (certain models only)
- Cleaning brush / cleaning cloth
- Milk cleaner
- O-rings and lubricating grease

















YOUR COFFEE MACHINE

Touch keys and symbols

Touch keys	
	<p>My profile Customise several beverage settings for the user profile that is shown in the primary screen.</p> <ul style="list-style-type: none"> • See chapter 'Customise beverages'. • You cannot use this touch key when the guest profile is shown on the display.
	<p>Settings</p> <ul style="list-style-type: none"> • See chapter 'Settings menu'.
	<p>User profile Touch this key to select the correct user profile. Six different user profiles and a guest profile are available.</p> <ul style="list-style-type: none"> • If you select a beverage that has been customised for this profile, it will be supplied with the customised saved settings. See chapter 'Supply a beverage that is customised'. • If you select the guest profile, beverages will be supplied with the default settings.
	<p>Customise a user profile</p> <ul style="list-style-type: none"> • See chapter 'Customise a user profile'.
	<p>Aroma Touch this key (several times) to select 'Pre-ground' or to select the aroma.</p>
	<p>Size Touch this key (several times) to select the coffee quantity.</p>
	<p>Scroll left/right Touch these keys until the correct variable is shown on the display.</p>
	OK
	Stop
	<p>Escape Cancel or go back one step.</p> <ul style="list-style-type: none"> • Values will not be saved.
	Next
	<p>Minus (-) / Plus (+) Adapt the aroma when you customise a beverage.</p>
	Start

YOUR COFFEE MACHINE

Touch keys	
	Enter Enter a menu.
	Double espresso This touch key is shown on the display for a few seconds at the start of preparing one espresso.
 Extra	Extra Increase the quantity of water of the beverage that is being prepared.
	On/Off Setting is 'off'.
	On/Off Setting is 'on'.

Symbols	
 my	My aroma (if programmed) / Standard
	Pre-ground
 my	Extra light
 my	Light
 my	Medium
 my	Strong
 my	Extra strong
 my	My quantity (if programmed) / Standard
 my	Small
 my	Medium
 my	Large
 my	Extra large
	Settings saved
	Default value
	Auto start function enabled
	Energy saving enabled
	Filter enabled

OPERATION

Before first use

Remove the packaging. Make sure the product is complete and undamaged. Check if all accessories are present. Do not use the appliance if it is visibly damaged. Contact the service department if there are any problems.



Coffee has been used to test the appliance in the factory. Therefore it is completely normal that there are traces of coffee in the mill.



Customise the water hardness as soon as possible. Obey the instructions in chapter 'Set the water hardness'.



To improve the performance of your appliance, we recommend installing a water softener filter. If your model is not provided with a filter, you can purchase one from the service department.



Always use clean and cold tap water, bottled water without added minerals or distilled water suitable for consumption.



The first time you use the appliance, the water circuit is empty. The appliance could be very noisy. The noise becomes less when the circuit fills with water.



The first time you use the appliance, you need to make 4-5 cups of coffee before it starts to give results that are satisfactory.



When making the first 5-6 beverages, it is normal to hear the noise of boiling water. This noise becomes less during use.



Pull the appliance forward to get access to the main switch, the area for accessories and the lid of the bean container. Pull the coffee spouts forward to open the service door.

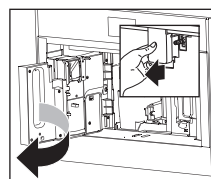
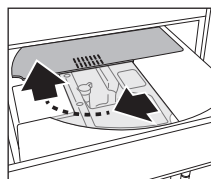
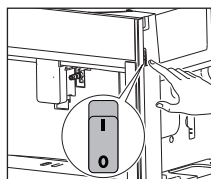
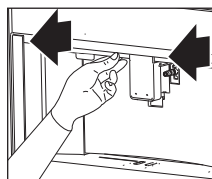

OPERATION



Read and obey the instructions shown on the display. The display shows information and touch keys to use. Important information is accompanied by an audio signal.

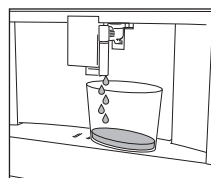
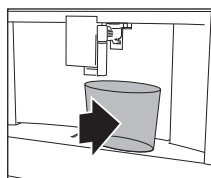
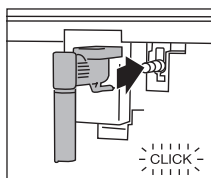
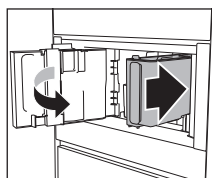
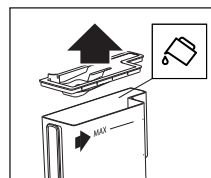
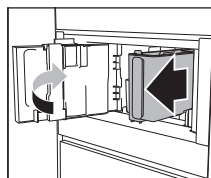
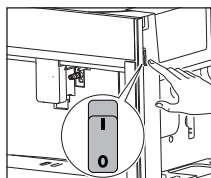
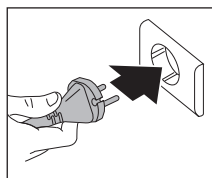

The appliance goes to standby automatically. It is now ready for normal use.



Danger of burns

During rinsing, a little hot water flows out of the coffee spouts. Avoid contact with splashes of water. Do not let the appliance stay unattended while hot water is being supplied.

OPERATION

Set your appliance to 'On'



The appliance is ready to use if it has reached the correct temperature.

The primary screen is shown.



Attention

Each time the appliance is set to 'On', it performs an automatic preheat and rinse cycle. This cycle cannot be interrupted. The appliance is ready for use only after completion of this cycle.



Tip

Put a cup under the spouts. Collect the hot water from the rinse cycle to warm the cup.



Important!

Do not push the main switch while the appliance is set to 'On'.

Set your appliance to 'Standby' and 'Off'

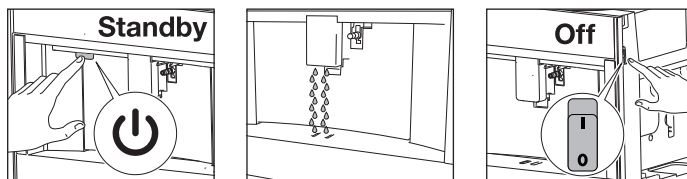

Attention

Each time the appliance is set to 'Standby' after being used to make coffee, it performs an automatic rinse cycle.



Please note

If you do not use the appliance for a long period, set the appliance to 'Off'.

OPERATION

Important tips and tricks when you make coffee

- The supply of coffee can be stopped at any moment.
- As soon as the supply has ended, you can increase the quantity of water.
- You can customise beverages.
- Adjust the grind level if the coffee is supplied a drop at a time or too weak and not creamy enough.
- Make a hotter coffee:
 - ▷ Perform a rinse cycle and warm the cups with the hot water from the rinse cycle.
 - ▷ Supply hot water to warm the cups.
 - ▷ Use the cup warmer setting to warm the cups.
 - ▷ Increase the coffee temperature.
- Lower the spouts to the cup as near as possible. This makes the coffee more creamy.
- After the coffee supply, the aroma setting and the quantity setting are reset to the 'original recipe'.
- Once a beverage has been made, the appliance is ready to make the next beverage.

Make coffee using coffee beans



Important!

Do not use green, caramelised or candied coffee beans. They could make the coffee mill unusable.

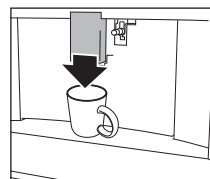
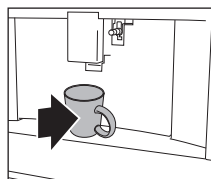
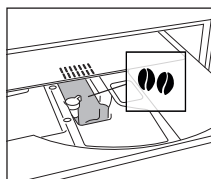
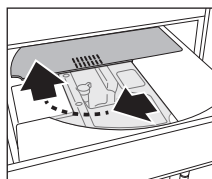

OPERATION

Make coffee using pre-ground coffee



Important!

- Only add pre-ground coffee when the appliance is set to 'On'. Otherwise, the coffee could spread through the inside of the appliance and damage it.
- Only make one cup of coffee at a time. Do not use more than 1 measuring spoon.
- Make sure the funnel is not blocked (see chapter 'Maintenance').

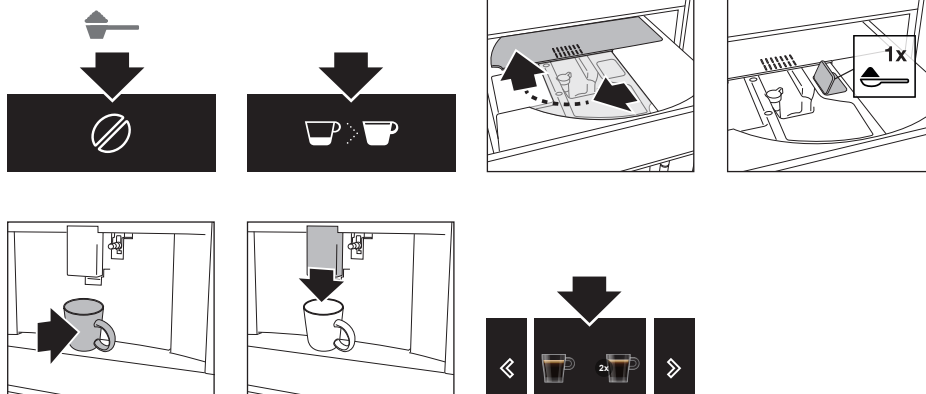

Adjust the grind level

The coffee mill is set by default to prepare coffee correctly. It should not require regulating initially. However, you can adjust the grind level:

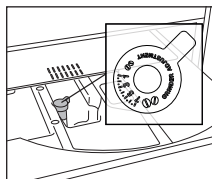

- if the coffee is supplied too slowly or not at all.
 - ▷ Turn the knob one click clockwise in the direction of 7.
- for a stronger, creamier coffee.
 - ▷ Turn the knob one click anti-clockwise in the direction of 1.



Please note!

- Only turn the knob when the coffee mill is operating (during the start of the coffee preparation). Turn the knob one click at a time. When you have made at least 2 cups of coffee, turn the knob another click if the adjustment did not give the desired result.



OPERATION

Make milk-based hot drinks



Tip

- Use skimmed or partially skimmed milk at refrigerator temperature (about 5 °C) to get a richer denser froth.

Dial position	Description	Recommended for...
	No froth	Caffe latte / Hot milk
	Min. froth	Latte macchiato
	Max. froth	Cappuccino / Frothed milk

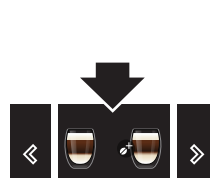
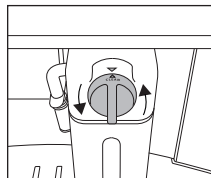
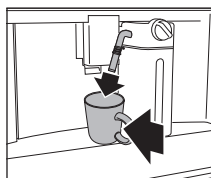
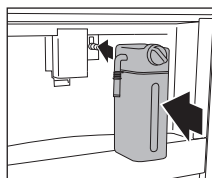
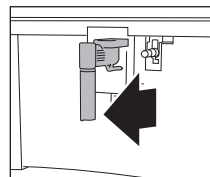
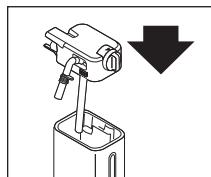
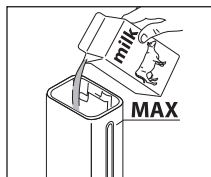
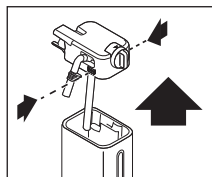

Please note!

- After the supply of a milk-based hot drink, the display shows a CLEAN message (see chapter 'Maintenance').

Make two cups of coffee

With this appliance you can make a perfect espresso or coffee. To guarantee the quality for each cup, we have chosen not to offer the option for two cups of coffee at the same time.

OPERATION

Customise beverages

The appliance allows you to choose six different profiles, each associated with a different icon. For every beverage, the customized aroma and amount can be saved in a profile.

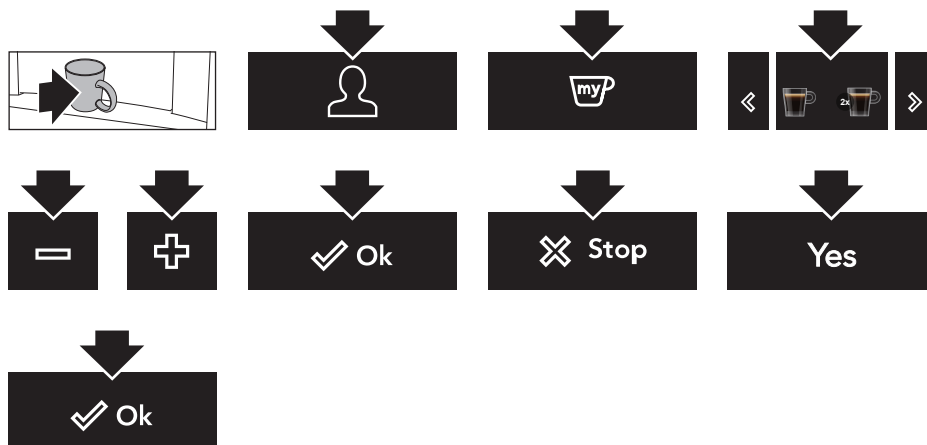

Supply a beverage that is customised

Make sure the primary screen shows the correct user profile. If you select a beverage that has been customised for this profile, it will be supplied with the customised saved settings.

 The order in which all the beverages for a user profile are displayed is based on the frequency of selection.



 If you select the guest profile, beverages will be supplied with the default settings.

OPERATION

Customise a user profile



Supply hot water or steam



Danger of burns

Do not let the appliance stay unattended while hot water or steam is being supplied.



Important!

Avoid burns from splashes. Always stop the hot water or steam supply before removing the cup containing the liquid.



Use steam to heat or froth liquid. Immerse the hot water spout in the liquid. When the required temperature or level of froth is reached, stop the steam supply.

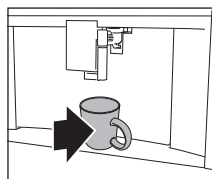
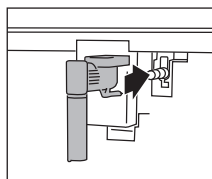

Tips when you use steam to froth milk

- When choosing the size of the cup, bear in mind that the liquid doubles or triples in volume.
- For a creamier froth, rotate the cup with slow movements up and down.













Please note!







Clean the hot water spout each time you used it to froth milk (see chapter 'Maintenance').

SETTINGS

Settings menu

	Rinsing Clean and heat the appliance's internal circuit. Supply hot water from the coffee spouts and hot water spout (if inserted). <ul style="list-style-type: none">Put a container with a minimum capacity of 100 ml under the coffee and hot water spouts.
	Descaling See chapter 'Maintenance'.
	Water filter See chapter 'Maintenance'.
	Drink settings Consult your customised settings for each profile. Reset the default values for each beverage. <ul style="list-style-type: none">See also 'Default values' for more information.
	Set time Adjust the time shown on the display.
	Auto-start Set the auto-start time. At that time, the appliance is ready to make coffee immediately. <ul style="list-style-type: none">To use this setting, make sure that the time of the day is correctly set.The corresponding symbol is displayed adjacent to the time to indicate that the setting is on.
	Auto-off (standby) Set the time for the appliance to go to standby.
	Cup warmer The fan blows hot air into the cup warmer area. <ul style="list-style-type: none">The residual heat of the appliance is used for heating up the cup. The heat result is depending on the time the machine is set to 'On'.
ECO	Energy saving The energy consumption is decreased in compliance with European regulations. <ul style="list-style-type: none">The corresponding symbol is displayed adjacent to the time to indicate that the setting is on.You may have to wait a few seconds before the first coffee is supplied.
	Coffee temperature Adjust the temperature of the water that is used to make coffee.
	Water hardness See chapter 'Maintenance'.

SETTINGS

	Set language Adjust the language shown on the display.
	Beep Set the beep on or off. <ul style="list-style-type: none">You hear a beep every time you touch a key and when you insert/remove an accessory.
	Lighting Set the lighting on or off. <ul style="list-style-type: none">The cup lighting comes on each time a beverage is supplied and during each rinse cycle.
	Background Set the color of the display background.
DEMO	Demo mode Start the demo mode to show the main functions. <ul style="list-style-type: none">To exit the demo mode, set your appliance to 'Standby'.
	Default values Reset all menu settings and programmed quantities back to the default values (with the exception of the language).
	Statistics Show statistics relating to the appliance.

MAINTENANCE

Clean your appliance



Read and obey the instructions shown on the display. The display shows information and touch keys to use. Important information is accompanied by an audio signal.



Please note!

- Do not use solvents, abrasive detergents, alcohol or chemical products to clean the appliance!
- Do not use metal objects to remove encrustations or coffee deposits. They could scratch metal or plastic surfaces.
- Only the milk container is dishwasher safe. Do not clean the other components of the appliance in the dishwasher!

Regular cleaning

- The hot water spout (each time you used it to froth milk).
- The internal tubes of the milk container and the hot water connection nozzle (each time a milk-based hot drink is supplied).
- The milk container and all the components (about once a month).
- The appliance's internal circuit.
- The coffee grounds container.
- The drip tray.
- The inside of the coffee machine (about once a month).
- The water tank (about once a month and when you replace the water softener filter).
- The coffee spouts.
- The pre-ground coffee funnel (about once a month).
- The brewing unit and the infuser (at least once a month).

Special cleaning



- Twice a year you must disassemble the brewing unit, clean the parts and lubricate the o-rings of the brewing unit and the infuser (see 'Clean the brewing unit / infuser twice a year').
- Each time the milk container is empty, we recommend to clean all components using the milk cleaner (see 'Use the milk cleaner').

MAINTENANCE

Clean the hot water spout

Clean the hot water spout each time you used it to froth milk. This avoids the build-up of milk residues and prevents it from clogging.

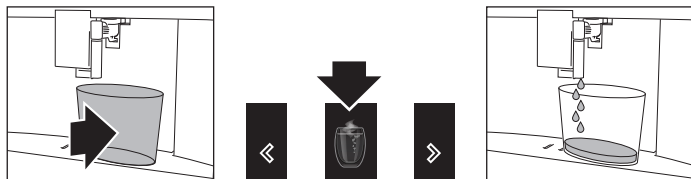

Wait a few minutes for the hot water spout to cool down.



Wash all parts of the spout thoroughly with a sponge and warm water.

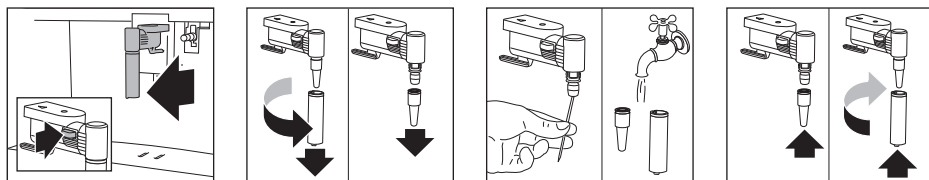

Clean the internal tubes of the milk container and the nozzle

Each time a milk-based hot drink is supplied, the display shows a CLEAN message. Put an empty cup under the milk spout before you obey this instruction shown on the display. Let the milk container stay in the appliance (you do not need to empty it).



Danger of burns

When cleaning the internal tubes of the milk container, a little hot water and steam leak out of the frothed milk spout. Avoid contact with splashes of water.

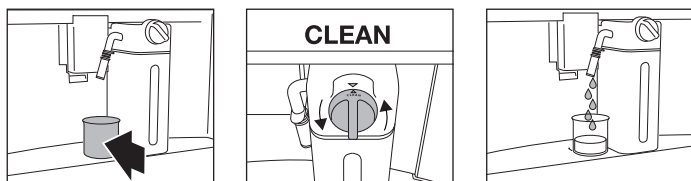

The cleaning stops automatically.

MAINTENANCE

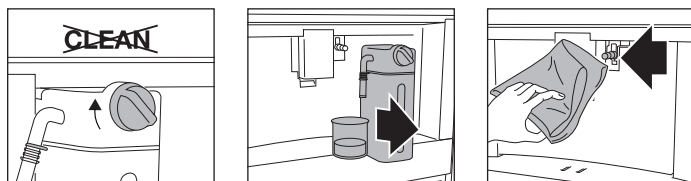

Any milk residues are removed now.



Please note!

To prepare a number of cappuccinos and milk based coffees, only confirm the CLEAN message after you have prepared the last beverage. To proceed with making the next beverages, touch the escape key.



If you touch the escape key, a symbol is shown on the display to remind you that the internal tubes of the milk container need cleaning.

Clean all components of the milk container



Important!

The thermal casing must not be filled with or immersed in water. Clean with a damp cloth only.

Wash all the components of the frother thoroughly with hot water and light washing-up liquid.



Only the milk container is dishwasher safe.

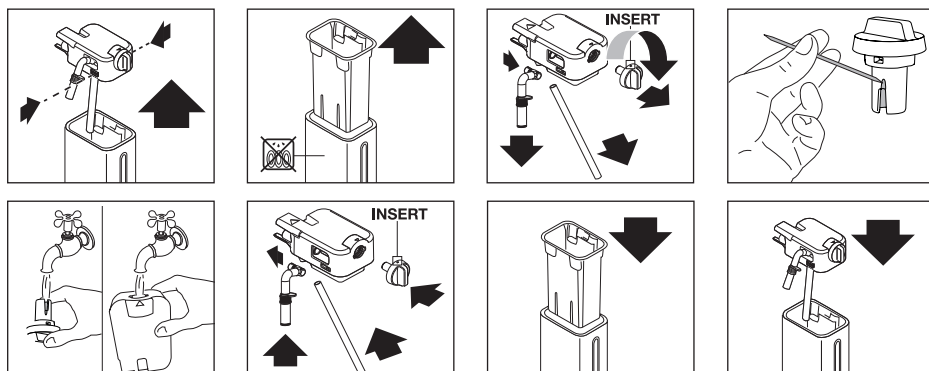

MAINTENANCE

Clean the appliance's internal circuit

If the appliance is not used for more than 3 or 4 days, we strongly recommend to obey these steps before using it again.

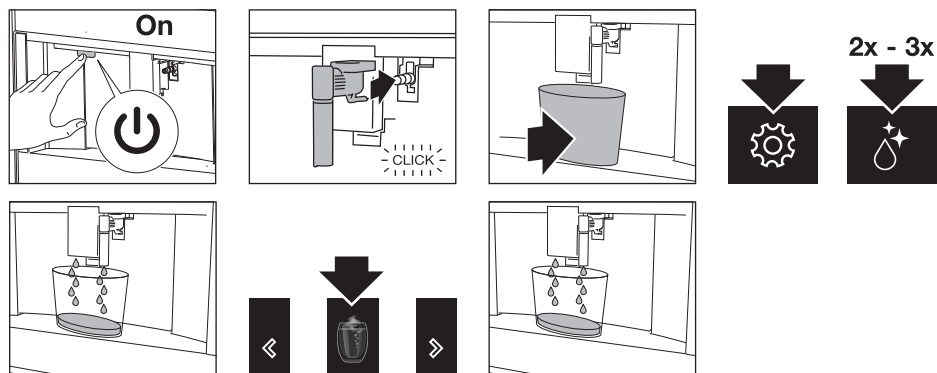

Clean the coffee grounds container



Important!

A message to empty the grounds container is displayed 72 hours after the first coffee has been prepared. Do not set the appliance to 'Off' with the main switch. If you do so, the 72 hours cannot be calculated correctly.

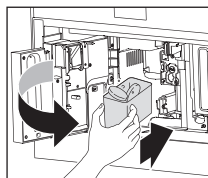
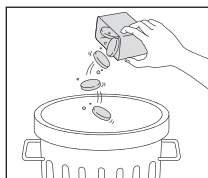
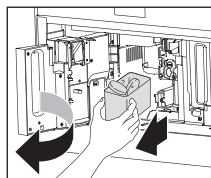

Important!

When removing the drip tray, the grounds container must be emptied, even if it contains few grounds. If this is not done before you make the next coffees, the grounds container may fill up more than expected and clog the appliance.

MAINTENANCE

Clean the drip tray



Important!

Clean and empty the drip tray before the indicator is above the cup tray. If you do not, water may overflow the edge and damage the appliance, the surface it rests on or the surrounding area.

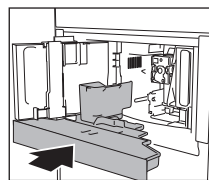
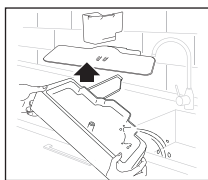
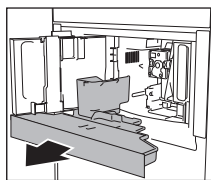
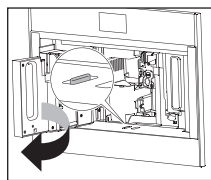

Clean the inside of the coffee machine



Important!

Before cleaning internal parts, set the appliance to 'Standby'. Do not immerse the coffee machine in water.

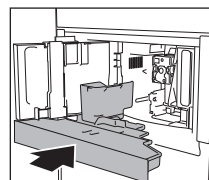
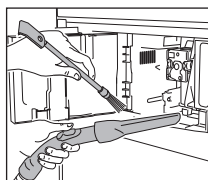
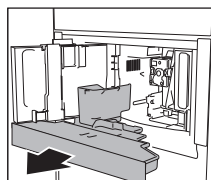
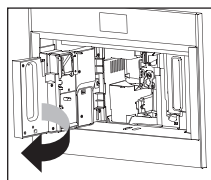

MAINTENANCE

Clean the water tank



Clean the water tank with a damp cloth and a little mild washing up liquid. Rinse thoroughly before filling the tank and putting it back in the appliance.

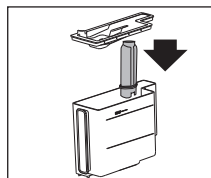
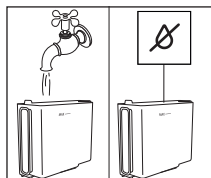
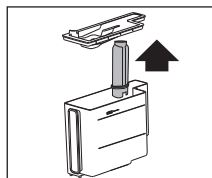

Clean the coffee spouts

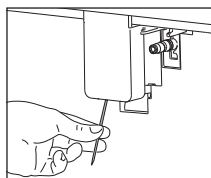
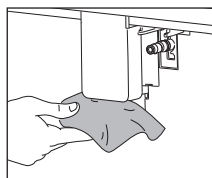

Clean the pre-ground coffee funnel

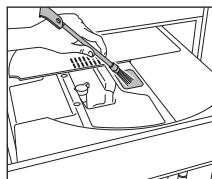

MAINTENANCE

Descal the appliance

Descal the appliance when the related message is shown on the display.

- To descale immediately, read and obey the instructions shown on the display.
- To descale the appliance later, touch the escape key.
 - A symbol is shown on the display to remind you that the appliance needs descaling.



Important!

Before use, read the instructions and the labelling on the descaler pack. You should use descaler authorised by the manufacturer only. Using unsuitable descaler and/or performing descaling incorrectly may result in faults not covered by the manufacturer's warranty.



Danger of burns!

Hot water containing acid flows out of the hot water spout. Take care to avoid contact with splashes of this solution.



Please note

- A series of rinses and pauses is performed automatically to remove all the scale residues inside the coffee machine. Empty the container every time after it has collected the rinsing water.
- If a filter was removed previously, the display will show the message when to insert the filter into the housing. If no filter was present, you can skip this step.
- If the descaling cycle is not completed correctly (e.g. no electricity) we recommend repeating the cycle.
- If the water tank has not been filled to the MAX level, at the end of descaling, the appliance requests a third rinse to guarantee that the descaler solution has been completely eliminated from the appliance's internal circuits. Before starting rinsing, remember to empty the drip tray.
- The appliance may request descaling cycles at very short intervals. This is normal due to the appliance's advanced control system.

MAINTENANCE

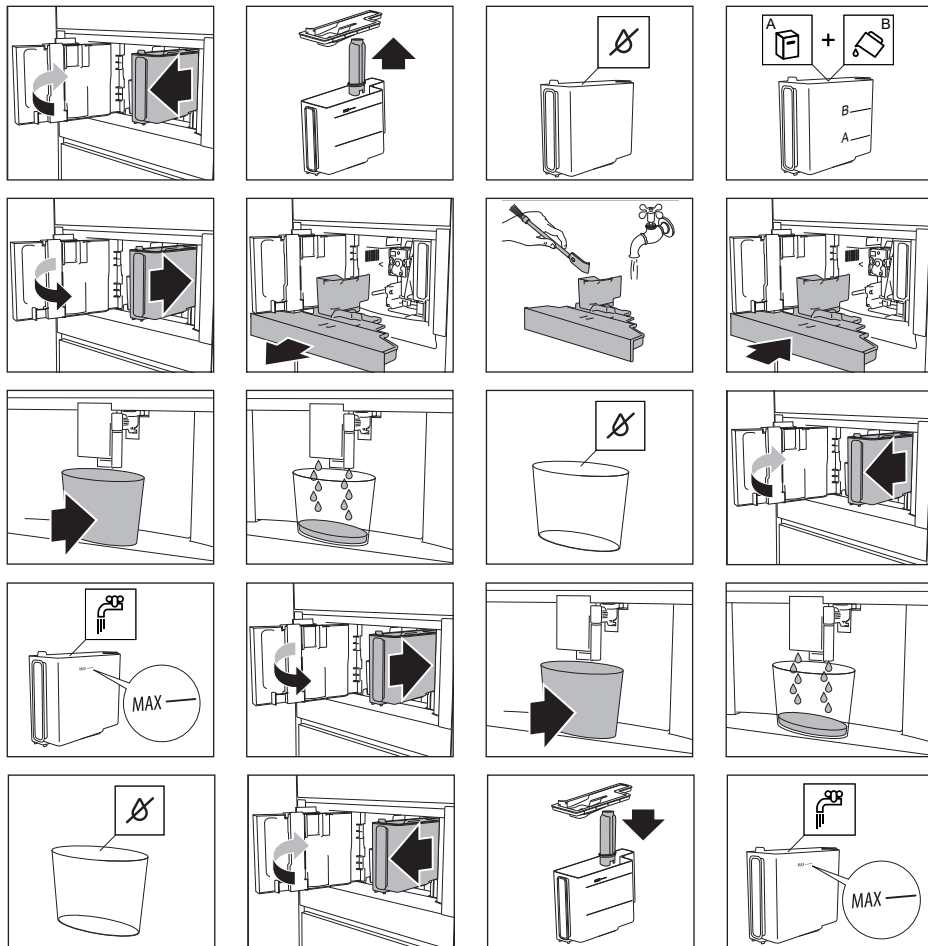

MAINTENANCE

Set the water hardness



The appliance is set by default for a hardness level of 4. The appliance can also be programmed according to the hardness of the mains water in the various regions. The appliance needs to be descaled less often if this hardness level is lower.

Immerse the 'total hardness test' indicator paper (attached to the instructions) in a glass of water for one second.

After about a minute, red squares can be seen.

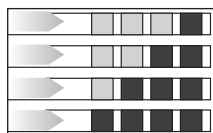

Level 1: soft water.

Level 2: moderately hard water.

Level 3: hard water.

Level 4: very hard water.



The appliance is now programmed with the new water hardness setting.

Install a water softener filter



Certain models are fitted with a water softener filter. If this is not the case with your model, you are recommended to purchase one from the service department.



Please note

The filter lasts about two months if the appliance is used normally. If the coffee machine is left unused with the filter installed, it will last a maximum of 3 weeks.

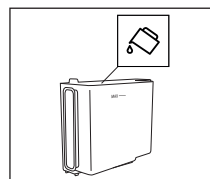
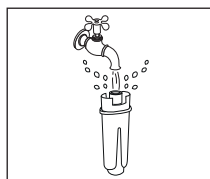
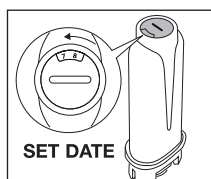

MAINTENANCE

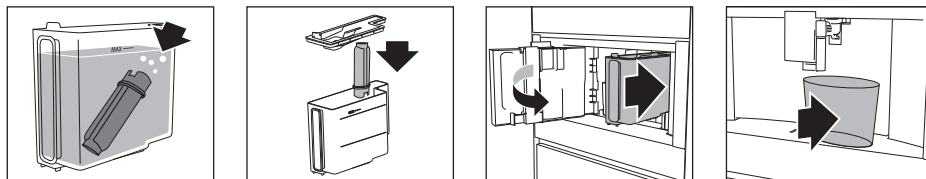

The water filter symbol is shown on the display adjacent to the time. This indicates that the filter has been enabled.

Replace a water softener filter

Replace the filter when the related message is shown on the display.

- To replace the filter immediately, read and obey the instructions shown on the display.
- To replace the filter later, touch the escape key.
 - A symbol is shown on the display to remind you that the filter needs to be replaced.



Take a look at the pictures in the previous section how to install the filter.



Please note

After two months (see date indicator) or when the appliance has not been used for 3 weeks, you should replace the filter even if the message has not been displayed yet.

Remove a water softener filter

If you want to use the appliance without the filter, you must remove it and notify the appliance of its removal.

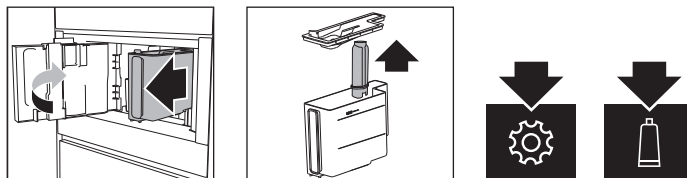

MAINTENANCE

Clean the brewing unit / infuser once a month



Important!

- Do not remove the brewing unit when the appliance is set to 'On'. Set the appliance to 'Standby'. Do not use force to remove the brewing unit.
- Do not use washing up liquid to clean the brewing unit. It would remove the lubricant applied to the inside of the piston.

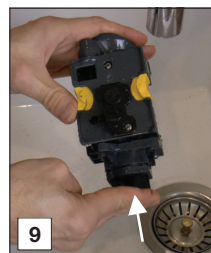
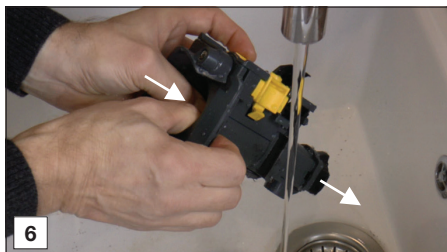
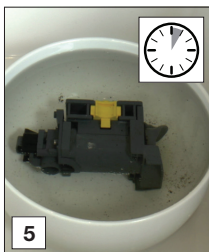
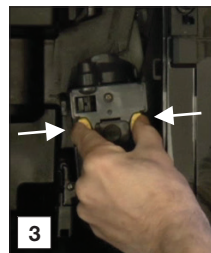
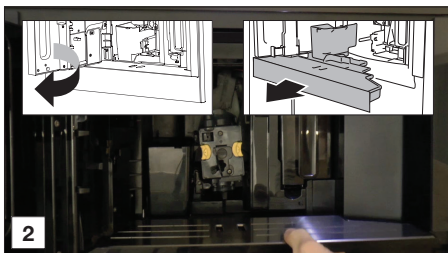
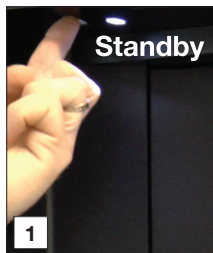

MAINTENANCE

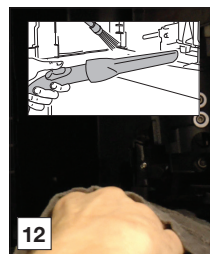
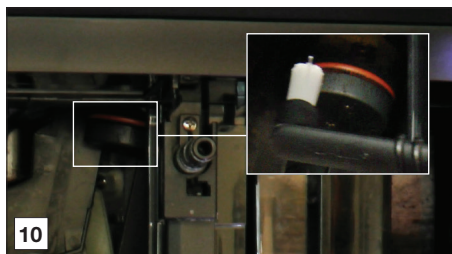

Clean the brewing unit / infuser twice a year



Important!

- Do not remove the brewing unit when the appliance is set to 'On'. Set the appliance to 'Standby'. Do not use force to remove the brewing unit.
- Do not use washing up liquid to clean the brewing unit. It would remove the lubricant applied to the inside of the piston.

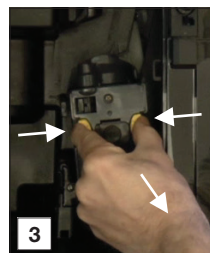
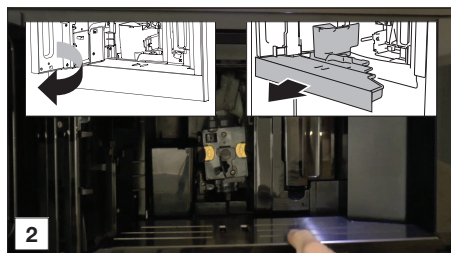
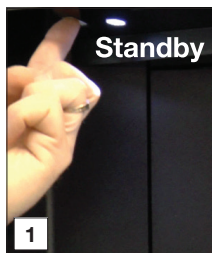

MAINTENANCE

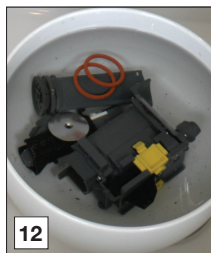
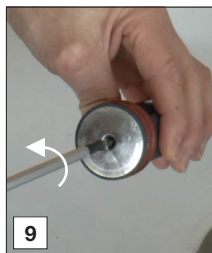
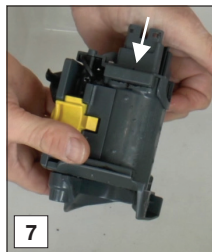
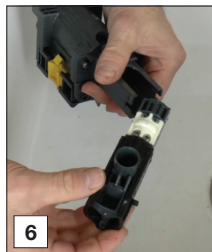
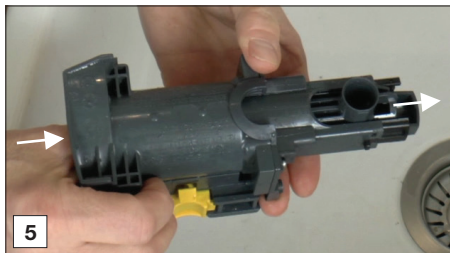
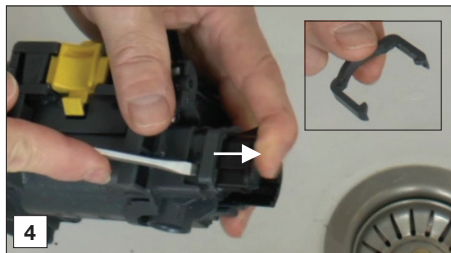

MAINTENANCE

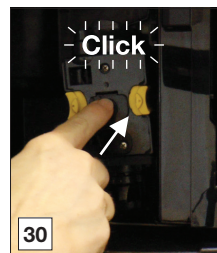
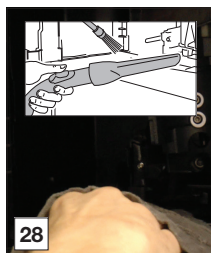
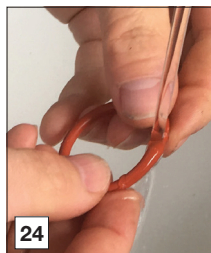
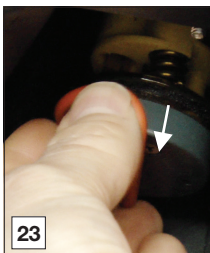
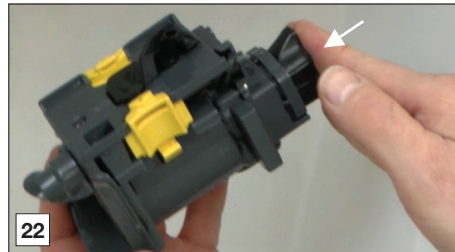
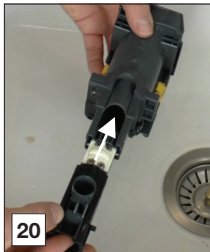
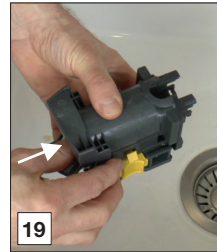

MAINTENANCE

Use the milk cleaner

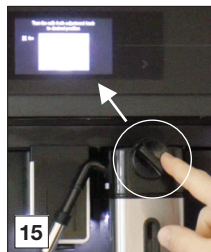
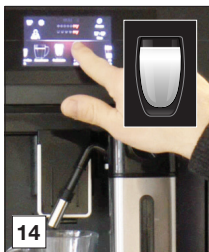
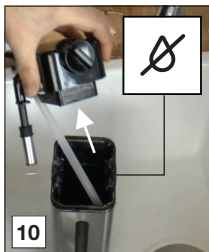
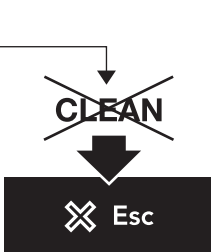
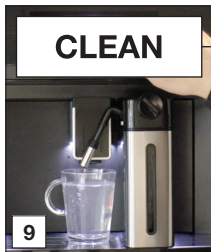
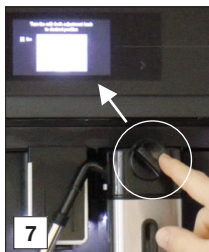

MAINTENANCE

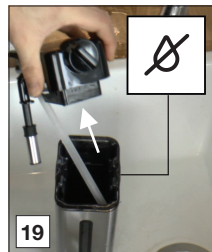
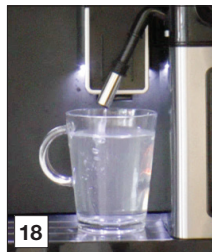

TROUBLE SHOOTING



Read and obey the instructions shown on the display. The display shows information and touch keys to use. Important information is accompanied by an audio signal.

If the given instruction shown on the display or the given remedy in the table below is not the solution to a problem, contact the Customer Services.

Problem	Possible cause	Remedy
	The inside of the appliance is very dirty.	Clean the inside of the appliance thoroughly.
		Disassemble and clean the brewing unit.
	Reminder that the appliance needs de-scaling and/or the filter must be replaced.	Replace or remove the water filter and/or descale the appliance as soon as possible.
	Reminder to clean the tubes inside the milk container.	Turn the milk froth adjustment knob to 'CLEAN'.
	Reminder to replace the filter.	Replace or remove the water filter.
	Reminder to descale the appliance.	Descal the appliance as soon as possible.
The coffee is not hot.	The cups were not preheated.	Warm the cups by rinsing them with hot water (you can use the hot water function).
	The brewing unit has cooled down because several minutes have elapsed since the last coffee was made.	Before making coffee, use the rinsing function to heat the brewing unit.
	A low coffee temperature is set.	Select a higher coffee temperature.
The coffee is weak or not creamy enough.	The coffee is ground too coarsely.	Adjust the grind level.
	The coffee is not correct.	Use coffee for espresso machines.
The coffee is supplied too slowly or a drop at a time.	The coffee is ground too finely.	Adjust the grind level.
The slices coffee grounds are soft and mushy.	The grind level is not correct.	Adjust the grind level (in the direction of 1).

TROUBLE SHOOTING

Problem	Possible cause	Remedy
Coffee does not come out of one or both of the spouts.	The coffee spouts are blocked.	Clean the coffee spouts.
The appliance does not make coffee.	The appliance has detected impurities in its internal circuits. See the information shown on the display.	Wait for the appliance to be ready for use again and select the required beverage again.
The appliance does not come on.	The appliance is not set to 'On'.	Push the main switch to set the appliance to 'On'.
		Push the On button to set the appliance to 'On'.
The brewing unit cannot be removed.	The appliance has not been set to 'Standby' correctly.	Push the Standby button to set the appliance to 'Standby'.
	The drip tray has not been removed.	Remove the drip tray.
	The brewing unit is not in the correct position.	Close the door and set the appliance to 'On'. The brewing unit automatically returns to the correct position.
The appliance makes a weird sound (not as normal).	The brewing unit and the infuser are dirty.	Clean the infuser and all parts of the brewing unit. Lubricate the o-rings with the lubricating grease.
At the end of descaling, the appliance requests a third rinse.	During the two rinse cycles, the water tank has not been filled to the MAX level.	Obey the instructions shown on the display.
The milk does not come out of the milk spout.	The lid of the milk container is dirty.	Clean all components of the milk container.
The milk contains large bubbles and squirts out of the milk spout or there is little froth.	The milk is not cold enough or is not semi-skimmed or skimmed.	Use skimmed or partially skimmed milk at refrigerator temperature (about 5 °C). If the result is not as you wish, try changing brand of milk.
	The milk froth adjustment knob is incorrectly adjusted.	Adjust the milk froth adjustment knob.
	The lid of the milk container or the milk froth adjustment knob is dirty.	Clean all components of the milk container.
	The hot water connection nozzle is dirty.	Clean the nozzle.

ENVIRONMENTAL ASPECTS

Disposal of packaging and appliance

Sustainable materials have been used during manufacture of this appliance. This appliance must be disposed of responsibly at the end of its service life. Ask your local authorities for more information about how to do this.

The appliance packaging is recyclable. The following materials may have been used:

- Cardboard.
- Polyethylene film (PE).
- CFC-free polystyrene (PS rigid foam).

Dispose of these materials in a responsible manner and in accordance with government regulations.



The product has been marked with a crossed-out dustbin symbol to remind you of the obligation to dispose of electrical household appliances separately. This means that the appliance may not be included with normal domestic refuse at the end of its service life. The appliance must be taken to a special municipal centre for separated waste collection or to a dealer providing this service.

Separate collection of household appliances helps to prevent any potential negative impact on the environment and on human health caused by improper disposal. It ensures that the materials of which the appliance is composed can be recovered to obtain significant savings in energy and raw materials.

Declaration of Conformity



We hereby declare that our products satisfy the applicable European Directives, Orders and Regulations, as well as the requirements stated in the referenced standards.



The appliance rating label is located on the side of the appliance.

When contacting the service department, have the complete type number to hand.

You will find the addresses and phone numbers of the service organisation on the guarantee card.

The instructions for use can also be found on our website:
www.asko.com

 **ASKO**



800659