

USER MANUAL

Read the manual carefully and ensure you have fully understood its contents before operating this device for the first time.

English

Contents

Live TV

Channel Scan.....	3
Channel List.....	4
Channel Edit.....	5
Favourite.....	6
Guide (EPG).....	7
PVR.....	8
Recording List.....	10
Timeshift.....	11

Connection

Wired Internet Connection.....	13
Wireless Internet Connection.....	13
Connecting Bluetooth Devices.....	14
Connecting Headphones.....	16
Connecting USB Devices.....	16
Connecting an Antenna.....	17
Connecting Audio Visual (AV) Devices.....	17
Connecting Speakers or Other Audio Receivers.....	18
Connecting a Digital Audio System with ARC/eARC.....	19
Using HDMI & CEC.....	20
Connecting a PC or Game Console.....	21
Using External Devices.....	21

Multi-screen

Screen Sharing.....	23
Content Sharing.....	23

Smart Functions

Getting Familiar with the Home Screen.....	25
Using a VIDAA Account.....	27
Using Voice Service.....	28
Media.....	31
App.....	35
Using the Art App.....	35
Enjoy the Internet.....	36
Data Protection and Security.....	37
Installing the Mobile App to Control your TV.....	37

Picture and Sound

Adjusting the Picture Quality.....	39
------------------------------------	----

Contents

Game Mode Settings.....	43
Adjusting the Sound Quality.....	44
SoundBar Settings.....	46
Speaker Settings.....	47
Using Headphones.....	48

Accessibility and System

Accessibility.....	49
Setting Time.....	49
Using Timer.....	50
Using Parental Controls.....	50
Setting Language and Location.....	51
Setting Power Indicator Mode.....	51
Screen Magnification.....	52
Setting Usage Mode.....	52
Using Remote Control Service.....	52
Checking the Software Version.....	53
Software Upgrade.....	53
HbbTV.....	53
Setting the TV Name.....	54
Enjoying Safe Use of the TV.....	54
Checking the TV Running Time.....	54
Reset to Factory Default.....	54

Troubleshooting

Picture Issues.....	55
Sound Issues.....	55
Network Issues.....	56
External Device Connection Issues.....	56
HDMI & CEC Issues.....	57
Media Files.....	58
Voice Service Issues.....	58
TV Status Diagnosis.....	58
Recording/Timeshift Issues.....	59
Other Issues.....	59

Using the E-Manual

Launching the E-Manual.....	61
Using the buttons in the E-Manual.....	61
Guidelines.....	61

Channel Scan

You can scan for channels automatically or manually.



Note:

- Satellite/antenna/cable function may not be applicable in some models/countries/regions.

Auto Scan

Automatic channel scan.

INPUT /  > TV

Alternatively, in Live TV,  /  > **Settings** > **Channel** > **Auto Scan**.

If no TV channels were saved before, you will be prompted to do a channel search.

Satellite

- **Single satellite:** You can use single satellite if you only have one satellite installed.
- **DiSEqC:** You can choose DiSEqC if you have DiSEqC equipment. Up to four satellites in DiSEqC 1.0 mode can be installed.

If you are using a motorised antenna, you can use DiSEqC 1.2 mode.

- **Unicable:** If your home is equipped with Unicable satellite distribution, you should use this option.

Please make sure that you know the Unicable band and frequency to be used. The information should be available on the equipment or the landlord can provide it.

Antenna

- **Channel:** Select from **All Channels** or **Free Channels**. This option may not be available depending on countries/regions/operators.
- **Scan Mode:** Select from digital channels only (DTV), digital and analogue channels (DTV+ATV) or analogue channels only (ATV).

If you receive DVB-T or DVB-T2 signal, you can use DTV.

- **LCN:** Switch on/off LCN (Logical Channel Number).

Please note that some operators are restricted to manually change the channel order. If you switch off LCN, then the channel list can be edited after channel scan.

This function may not be applicable in some models/countries/regions.

Cable

- **Channel:** Select from **All Channels** or **Free Channels**. This option may not be available depending on countries/regions/operators.
- **Scan Mode:** Select from digital channels only (DTV), digital and analogue channels (DTV+ATV) or analogue channels only (ATV).
- **LCN:** Switch on/off LCN (Logical Channel Number).

Please note that some operators are restricted to manually change the channel order. If you switch off LCN, then the channel list can be edited after channel scan.

This function may not be applicable in some models/countries/regions.



Manual Scan

Manually scan for channels for DTV or ATV.

In Live TV,  /  > **Settings** > **Channel** > **Advanced Settings** > **Manual Scan**

DTV Manual Scan

Manually scan for DTV services.

When the DTV Manual Scan screen appears, press  /  button to select **Antenna**, **Cable** or **Satellite** and select **Start** to commence the search of that channel. When the signal has been received, the signal strength will be displayed on the screen.



ATV Manual Scan



Manually scan for ATV services.



- **Frequency:** Input the channel frequency you want.
- **Picture System:** Select the Colour System.
- **Sound System:** Select the Sound System.



Live TV tutorial

After channel scanning has completed for the first time, the Live TV operating tutorial will be displayed, this will include:

 /  /  : Load the info bar

 /  : Load the channel list

 /  : Open the electronic programme guide (only available in some models/countries/regions)

 /  : Load on-screen menu

 : Call up search function



 : Jump to the previous channel

Note:

- The remote control buttons may vary depending on models/countries/regions.

Channel List

Displaying the channel list

In Live TV, press  /  button to display the Channel List menu.

Alternatively, in Live TV,  /  > **Channel List**.

Entering the sub-menu of channel list

In Live TV,  /  > 

Live TV

Introducing the sub-menu

In Live TV, **OK**/**CHLIST** > **➤**

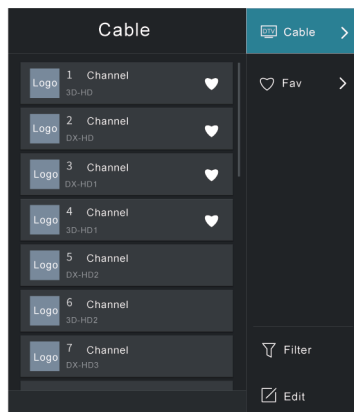

TV List

Display Live TV channel categories, such as **Cable** and **Antenna**.

Fav

Display favourite lists 1 to 4.

Filter

Select channels by **Content**, **HD**, **Child Lock**, **Scrambled** and **Sort**.

Some options in **Filter** may not be available in some models/countries/regions.

Edit

Edit the channel list.

Note:

- The sub-menu options may vary depending on models/countries/regions.

Channel Edit

Manually edit the channel list to your preference.

Editing Live TV channels

In Live TV, press **OK**/**CHLIST** > **➤** to select a Live TV channel category such as Antenna or Cable, then use D-pad to select **Edit**.

Alternatively, in Live TV, press **≡**/**≡** button, select **Settings** > **Channel** > **Channel Edit**, and select a Live TV channel category such as Antenna or Cable.

Live TV

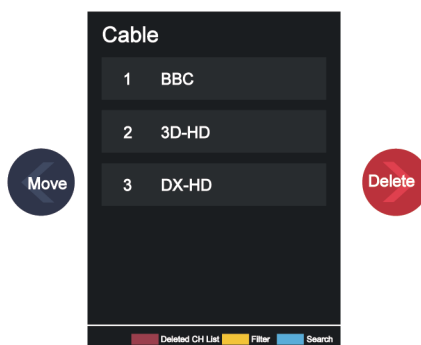

- Press **OK** button on the selected channel, then a checkbox will appear. You can select multiple channels at the same time to move or delete.
- Move: Press **←** button to move the selected channel.
Moving the channels could be restricted by the operator. If you want to be able to move channels, it is not recommended to choose an operator during channel scan, and LCN should be set to Off.
- Delete: Press **→** button to delete the selected channel.
- Restore: Press **[RED]** button, or press **[Color Menu] / [123]** button to display the colour menu and select RED to enter the list of deleted channels. Press **←** button to restore the deleted channel.
- Filter: Press **[YELLOW]** button or press **[Color Menu] / [123]** button to display the colour menu and select YELLOW, the filter screen will pop up. Press **OK** button to select options, the channel list can then be updated.
- Search: Press **[BLUE]** button or press **[Color Menu] / [123]** button to display the colour menu and select BLUE to search for a channel.

Exporting to USB

The current channel list can be exported to a USB storage device.

In Live TV, **[Home] / [Menu] > Settings > Channel > Channel Edit > Export to USB**

Importing from USB

Previously exported channel lists can be imported via a USB storage device.

In Live TV, **[Home] / [Menu] > Settings > Channel > Channel Edit > Import from USB**

[Menu] Related information



[Connecting USB Devices](#) on page 16

Favourite

Adding a channel to a favourite list

1. In Live TV, press **OK / [CHLIST]** button to display the channel list.





Live TV

2. Press  /  button and select the channel(s) you want to add to the favourite list.
3. Select **Add to Favourite** and choose from **FAV1-FAV4**.
4. Then, a heart-shape icon will appear next to the added channel.

Viewing your favourite list

In Live TV, press  /  >  > **Fav** to display the favourite list.



Editing the favourite list

In Live TV, press  /  >  > **Fav** >  to select **FAV1-FAV4**, then use D-pad to select **Edit**.

Alternatively, go to  /  > **Settings** > **Channel** > **Channel Edit**, and select **FAV1 - FAV4**.

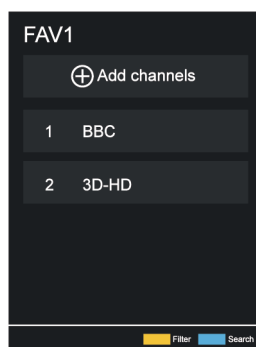
You can add, move, or remove favourite channels.



- Select  **Add channels** to add the selected channel to the favourite list.
- Select a channel in a favourite list, and press  button to move it.
- Select a channel in a favourite list, and press  button to remove it.

Note:

- These steps should be operated under the TV input.
- Before you edit the favourite lists, Channel Scan must be completed first.
- You can add channels from various reception types to the favourite list.



Guide (EPG)

The Guide (EPG) provides a convenient way to check TV programmes for the upcoming 7 days. The information displayed by the Guide (EPG) is made available by the commercial television networks for digital channels only. The Guide (EPG) also provides a simple way to record your favourite programmes and a reminder function, which can switch channels automatically at scheduled time, so that you will not miss programmes of interest. The availability and amount of programme information will vary depending on the broadcaster.

Note:

Live TV



- The Guide (EPG) function is only available for digital channels. Analogue channels are not supported.

In Live TV, press  button, or press  > **Guide (EPG)** to display channel information Guide.

- **Watch**

In Guide (EPG), when a current programme is selected, press  > **Watch** to switch to the channel you want to see.

- **PVR/Reminder**



In Guide (EPG), press  button to select the channels. Press  button to select programme based on the time schedule.

Press  button to select **PVR** or **Reminder**.



For more information, please refer to [Live TV > PVR](#) in this manual.

Note:





- Reminder in the Guide (EPG) is only available for programmes that have not been aired yet.
 - A storage device (space should be no less than 2GB, and the transfer rate should be no less than 4MB/s) must be attached to the TV for recording purposes. It is strongly recommended to use a USB mobile hard disk drive instead of a USB flash drive as the storage device. For more information, please refer to [Connecting USB Devices](#) in this manual.
 - The TV can record the programme in standby mode.
 - The PVR function may not be applicable in some models/countries/regions.
- **Schedule**

In Guide (EPG), press  [RED] button or press  button to display the colour menu and select RED. This will display a list of scheduled reminders and recordings.

- **Programme Colour**

In Guide (EPG), press  [GREEN] button or press  button to display the colour menu and select GREEN. Use the colours to indicate different genres in the Guide (EPG) for quick and easy viewing.



Note:



- This function may not be applicable in some models/countries/regions.
- **24h-**
- In Guide (EPG), press  [YELLOW] button or press  button to display the colour menu and select YELLOW to select programmes of the previous day.
- **24h+**
- In Guide (EPG), press  [BLUE] button or press  button to display the colour menu and select BLUE to select programmes of the next day.



PVR

The PVR function allows you to easily record digital television content for later viewing. The function is only available for digital channels. To use PVR, you must connect a storage device for recording. The format of the storage disk can be NTFS or FAT32. The PVR will not function if a data storage device has not been connected. For more information, please refer to [Connecting USB Devices](#) in this manual.

Schedule Recording



In Live TV, press  /  > **PVR**.

Alternatively, press  /  /  button to load the info bar, and select a programme and choose **PVR**.

If your remote has  button, press it and use D-pad to select  to set up PVR.

You can select recording mode from time, manual stop and programme.

When you select time, you can set the booking time and period.

In Guide (EPG), press the  [RED] button or press  /  button to display the colour menu and select RED, to view the scheduled recording. In the schedule recording list, you can readjust the reservation information that has been set.

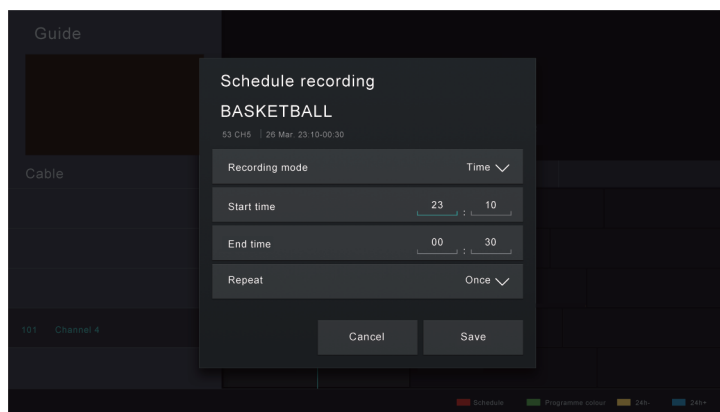

Standby Recording

If you press the power button during recording and select **Standby Recording**, your TV will go into standby mode, but the recording process will continue. If you press the power button again to wake up the TV, the recording process will not be affected. After recording, the recorded file will be automatically saved to the attached USB disk.

Background Recording

When you switch to an App or another source (e.g. HDMI) during recording, the recording process will continue. When the recording has completed, the recorded programme will be automatically saved to the attached USB disk.

If you want to manually stop recording, press **INPUT** /  > **TV** to switch back to the channel that is currently being recorded, and then press  /  button and select  on-screen to stop.

Note:

- The storage space of your device should be no less than 2GB (for 15 minutes high-definition video). It is strongly recommended to use a USB mobile hard disk drive instead of a USB flash drive as the storage device.
- If the transfer rate of your hard disk is too slow, a pop-up notice will be displayed. In this case, you will need to use another disk with higher speed.

Live TV

- The PVR function does not support analogue channels.
- Some broadcasters may restrict the recording of programmes.
- If a recording is made from a locked channel, the system PIN will need to be input to playback the recorded content.
- Some channel-related configuration may conflict with background recording. In this case, a reminder window will pop up.
- The PVR function may not be applicable in some models/countries/regions.

Recording List

Accessing the recording list

View the list of recorded programmes and scheduled list.

To enter the recording list:

In Live TV,  /  > **Recording List**

Managing the recording list

In Live TV,  /  > **Recording List > Recorded**

You can watch, sort, or delete recorded programmes.

Watch recorded programme

Select a recorded programme in the recording list, and press  button to watch it.

Sort recorded programmes

Select **All**, and you can choose from the list to sort the recorded programmes.

Note:

- This function may not be applicable in some models/countries/regions.

Delete recorded programme

Select **Edit**, select a recorded programme in the recording list, and press  button to delete it.

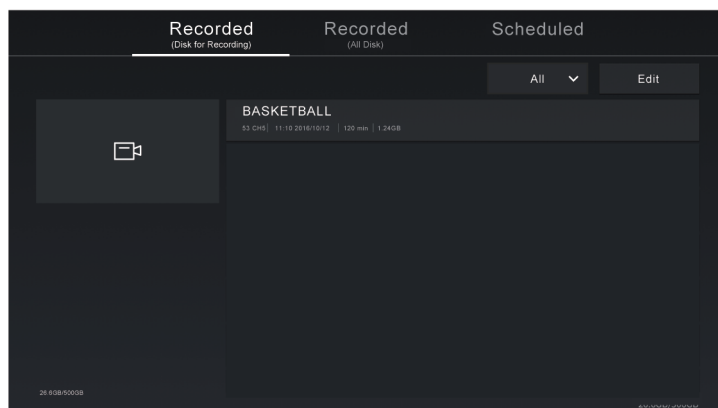

Live TV

If you connect more than one storage devices to the TV, **Recorded (Disk for Recording)** and **Recorded (All Disk)** are available on-screen to select.

In **Recorded (Disk for Recording)**, you can watch recorded programme of the storage device that is selected at **Home/Menu > Settings > System > Advanced Settings > PVR & Time Shift > PVR Setup/Time Shift Setup**.

Managing the schedule list

In Live TV, **Home/Menu > Recording List > Scheduled**

You can change scheduled recording information and reminder information, or cancel scheduled recordings or reminders.

Delete scheduled recording or reminder

Select **Edit**, select a scheduled recording or reminder in the schedule list, and press **Right Arrow** button to delete it.

Edit scheduled recording or reminder

Select scheduled recording or reminder in the schedule list, then press **OK** button to edit.

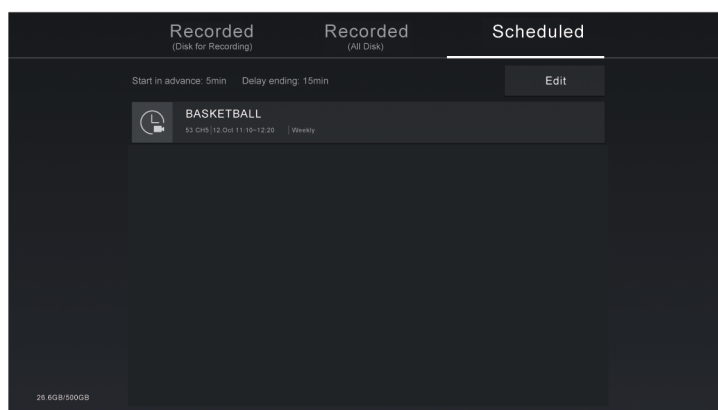

Note:

- The Recording List function may not be applicable in some models/countries/regions.

Menu/Info Related information

[Connecting USB Devices](#) on page 16

[Recording/Timeshift Issues](#) on page 59

Timeshift





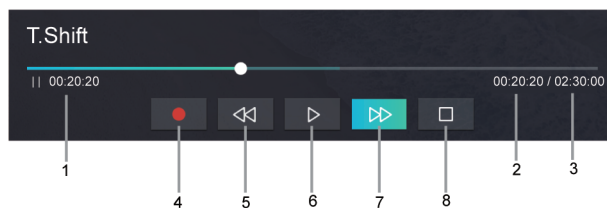

This option allows you to pause and rewind Live TV. This function operates by recording temporarily to a storage device. Please ensure your storage device is connected and there is enough free disk space. Otherwise, the Timeshift function will not commence.

In Live TV, press **Home/Menu > Timeshift**, and then the playback bar will appear.

If your remote has **Play/Pause** button, press it and press **OK** button to launch Timeshift.

Live TV



- 1 Unwatched time for buffered content
- 2 Current time
- 3 Total time
- 4  Record: to convert a Timeshift to a live recording of the current broadcast channel. Select  and the programme content you have watched in Timeshift will also be saved to the storage device.
- 5  Fast backward: you can choose 2x, 4x, 8x or 16x.
- 6  Pause/  Play
- 7  Fast forward: you can choose 2x, 4x, 8x or 16x.
- 8  Stop Timeshift: to exit the function and watch the current broadcast.

Note:

- The Timeshift function does not support analogue channels.
- The storage space of the device should be no less than 2GB. It is strongly recommended to use a USB mobile hard disk drive instead of a USB flash drive as the storage device.
- The Timeshift function may not be applicable in some models/countries/regions.

Related information

[Connecting USB Devices](#) on page 16

[Recording/Timeshift Issues](#) on page 59

Connection

Wired Internet Connection

Connecting to a wired (Ethernet) network

To get access to the Internet using a wired connection, it is recommended to use a modem or router that supports Dynamic Host Configuration Protocol (DHCP). Modems and routers that support DHCP automatically provide the IP address, subnet mask, gateway, and DNS, so you do not have to enter them manually. Most home networks already have DHCP.

See the illustration below.

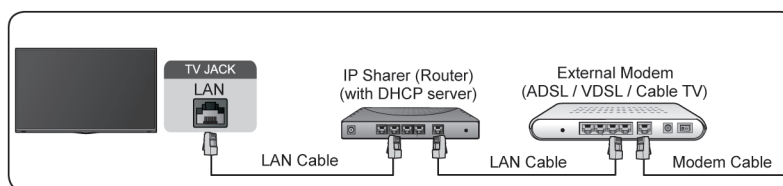

After connecting to a wired (Ethernet) network:

/ > **Settings** > **Network** > **Network Configuration**

Set the TV network by selecting **Network Configuration** and press button to enter the submenu.

- **Connection Type**

Choose a wired (Ethernet) network connection to access the Internet.

- **Ethernet**

Display network status.

- **IP Settings**

Configure the IP setting for your network connection.

Wake on LAN

/ > **Settings** > **Network** > **Wake on LAN**

With a wired Ethernet connection and enabling **Wake on LAN**, you can switch on the TV from standby and push content to be viewed on the TV with a mobile device Application supporting the screencast function.

Note:

- To use this function, make sure your TV and mobile device are connected to the same network environment.
- Enabling this function may result in higher energy consumption.

Wireless Internet Connection

Connecting to a wireless network

To connect to an available wireless network, make sure that you turn on your wireless router and have the wireless router's SSID and password before attempting to connect.

Connection

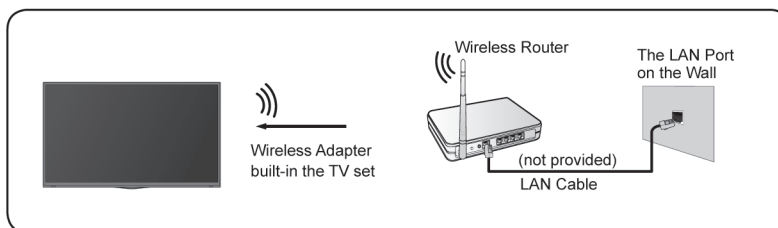

To get access to the Internet using a wireless connection:

/ > **Settings** > **Network** > **Network Configuration**

Set the TV network by selecting **Network Configuration** and press button to enter the submenu.

- **Connection Type**

Choose a wireless network connection to access the Internet.

- **Advanced Settings**

Configure the advanced wireless network settings for the TV.

- **Add**

You can add a wireless network.

- **Refresh**

Refresh wireless network.

Note:

- If no wireless router is found, select **Add** and enter the network name in the SSID.
- If no wireless router is found, select **Refresh**.

Wake on wireless network

/ > **Settings** > **Network** > **Wake on Wireless Network**

With a wireless network connection and enabling **Wake on Wireless Network**, you can switch on the TV from standby and push content to be viewed on the TV with a mobile device Application supporting the screencast function.

For more information about the screencast feature, please refer to [Multi-screen > Screen Sharing](#) or [Content Sharing](#) in this manual.

Note:

- To use this function, make sure your TV and mobile device are connected to the same network environment.
- Enabling this function may result in higher energy consumption.



Related information

[Network Issues](#) on page 56

Connecting Bluetooth Devices

You can connect to devices using Bluetooth technology.

Connection



 /  >  **Settings** > **Network** > **Bluetooth**

Note:



- Bluetooth function may not be applicable in some models/countries/regions.

Connecting a Bluetooth remote

Pair the Bluetooth remote with the TV.







1. To pair the Bluetooth remote to the TV after you power the TV on, select  /  >  **Settings** > **Network** > **Bluetooth** to **On**, and then select **Remote Control Auto Pairing** to **On**.
2. Keep the remote control within 3 metres of the TV. Press any button (except power and mic button) to pair the remote with the TV.

Note:

- In special cases, press and hold  /  button to pair.
- This function may not be applicable in some models/countries/regions.
- If an error occurred while trying to pair the remote, it could have been caused by interference. Try to remove what is causing the interference and try pairing again.
- If an error occurred with the remote while using sufficiently charged batteries, you can take out the batteries for 1~2 seconds then insert them back again. Now the remote will work normally.
- The remote cannot be paired to the TV while the TV is in standby mode.

Connecting a Bluetooth device

To pair a Bluetooth device, such as Bluetooth headphones, speakers, keyboards, mouse or even mobile devices:

1. Set  /  >  **Settings** > **Network** > **Bluetooth** to **On**.
2. Before pairing your Bluetooth device, make sure it is in the pairing mode and placed within pairing range. To put your Bluetooth device in pairing mode, refer to the user manual of your device.
3. Find the Bluetooth device name in  /  >  **Settings** > **Network** > **Bluetooth** > **Equipment Management** and select it. The device will be automatically connected to the TV.

Note:

- Only one Bluetooth speaker or Bluetooth headphone can be connected to the TV. If a new Bluetooth speaker or headphone connects to the TV, the existing one will be disconnected automatically.
- Some compatibility issues may occur depending on the Bluetooth device support.
- Bluetooth keyboards may not be functional with some applications.
- The TV and Bluetooth devices may become disconnected if the distance between them is too high.
- For more information about Bluetooth headphone settings, please refer to [Picture and Sound > Using Headphones](#) in this manual.

Listening to the audio through Bluetooth devices

Pair the Bluetooth audio device using the TV's Bluetooth setup process. Refer to the user manual for your audio device, such as Bluetooth speaker or sound bar, for detailed connection and setup.



After the Bluetooth connection is completed, go to  /  >  **Settings** > **Sound** > **Speakers** > **Audio Output**, and then select **Bluetooth Speaker** option to listen to the audio through Bluetooth devices.

Connection

Note:

- Compatibility issues may occur depending on the Bluetooth device.
- The TV and Bluetooth devices may become disconnected if the distance between them is too high.



TV Bluetooth speaker

 /  >  **Settings** > **Network** > **Bluetooth** > **TV Bluetooth Speaker**

Mobile devices are connected to the TV via Bluetooth and audio is played via the TV speaker.

When your mobile device is connected to the TV via Bluetooth, you can play your mobile phone's music through the TV built-in speakers.

Go to your mobile Settings to enable Bluetooth and choose the TV to connect.

To use this function, make sure to select **TV Speaker** at  /  >  **Settings** > **Sound** > **Speakers** > **Audio Output**.

Related information



[Speaker Settings](#) on page 47

Connecting Headphones

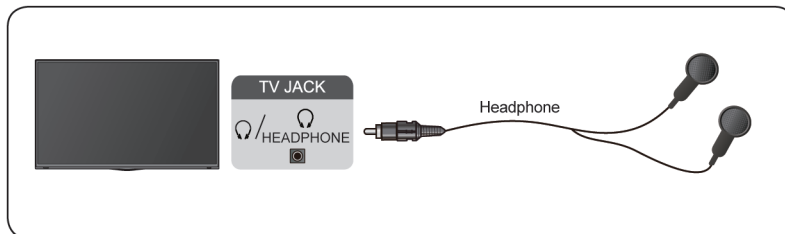
You can connect a pair of headphones (not provided) to the HEADPHONE port on your TV. While the headphone is connected, the sound from the built-in speakers will be disabled.



Note:

- Headphone port may not be available in some models.
- Headphones with microphones are not supported.
- If **Headphone with Speakers** is selected manually in  /  >  **Settings** > **Sound** > **Headphone** > **Headphone Mode**, the headphone and the TV will have sound output at the same time.
- For more information about headphone settings, please refer to [Picture and Sound > Using Headphones](#) in this manual.

Connecting USB Devices

Connect USB devices, such as hard drives and USB sticks for browsing photos or listening to music.

Connection

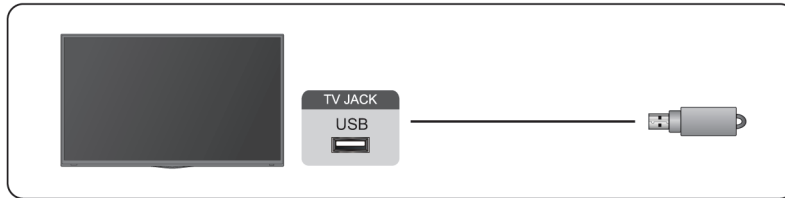

Note:

- USB disk sizes 4GB, 8GB, 16GB, 32GB, 64GB, 128GB and other common market sizes are supported. Up to 8TB hard drives are supported.
- Supported formats: NTFS, FAT32.
- Select the content you want to play or view. For more information, please refer to [Smart Functions > Media](#) in this manual.

Connecting an Antenna

You can connect an antenna cable to your TV.

Using your remote, select  **Input** icon in Home screen and select **TV** as the input source.

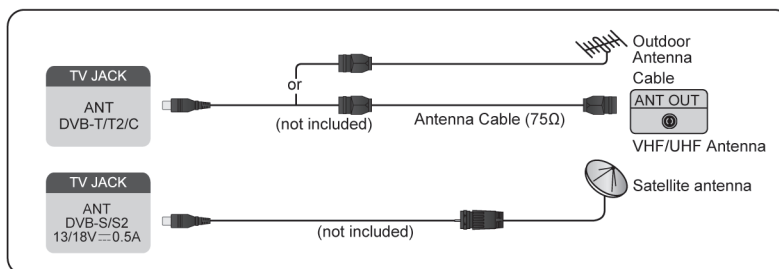

Note:

- TV jacks may vary and satellite/antenna/cable function may not be applicable in some models/countries/regions.

Related information

[Channel Scan](#) on page 3

Connecting Audio Visual (AV) Devices

Connecting with a Composite video cable

To connect an AV device with a composite video cable (not provided), see the illustration below.

When the connection is completed, using your remote, select the  **Input** icon on the Home screen and select **AV** as the input source.

Connection

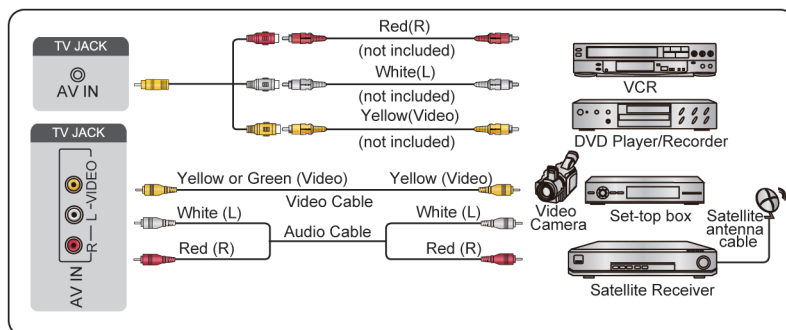

Note:

- AV IN port(s) may vary depending on model type.
- AV IN port(s) may not be available in some models. Please use other port(s) to connect AV devices.

Connecting a HDMI cable

To connect an AV device with a HDMI cable (not provided), see the illustration below.

When the connection is completed, using your remote, select the  **Input** icon on Home screen, and select the corresponding HDMI input.

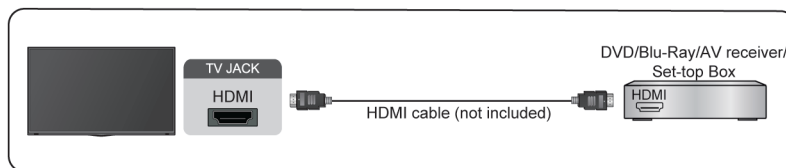

Note:

- Please refer to the User Manual of your device for step-by-step instructions.
- Some devices, such as DVD players, require the HDMI signal to be set to the correct format in the device settings. Please consult your device user manual for instructions.
- If there is no sound from your TV, configure the device audio settings.

Related information

[Using HDMI & CEC](#) on page 20

Connecting Speakers or Other Audio Receivers

To connect speakers or other audio receivers with an audio cable (not provided), see the illustration below.

Ensure the audio connected devices are switched on before switching on the TV.

When the connection is completed, go to   >  **Settings** > **Sound** > **Speakers** > **Audio Output**, and select the **SPDIF Only** option.

When a digital audio system is connected to the DIGITAL AUDIO OUT port, decrease the TV volume, and use your digital audio system to control the volume.

Connection

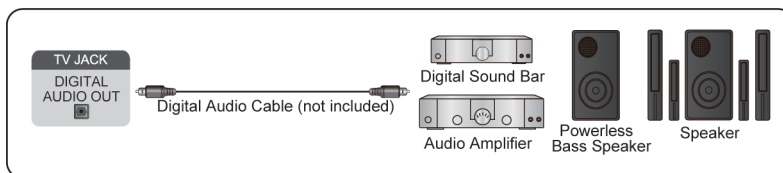

Note:

- If you prefer to use Audio Return Channel/Enhanced Audio Return Channel, please refer to [Connection > Connecting a Digital Audio System with ARC/eARC](#) in this manual.
- You can connect the DIGITAL AUDIO OUT port on the back of the TV to the optical port on the amplifier. Then go to **Settings > Sound > Speakers > Digital Audio Output** to select **Dolby Audio - Dolby Digital** to receive the Dolby Digital audio.

Related information

[Speaker Settings](#) on page 47

Connecting a Digital Audio System with ARC/eARC

If you would like to use the Audio Return Channel (ARC)/the Enhanced Audio Return Channel (eARC) feature to send sound from the TV by a HDMI cable to a digital sound system, you can connect it to the HDMI (ARC/eARC) port of your TV.

By using this feature, you can also control the sound system with your TV remote instead of using the remotes for each device.

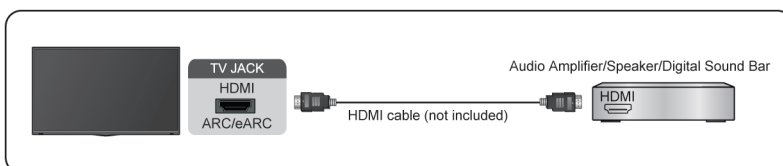

After the connection:

1. Power on the sound system.
2. Press **Home** button to select **Settings** icon on the Home screen.
3. Select **Sound > Speakers > Audio Output**, and select **ARC** option. If the device supports eARC function, press **Home** button to select **Settings** icon on the Home screen, and select **Sound > Speakers > eARC** to set eARC to **On**.

Note:

- Audio receiver must support ARC/eARC function.
- If the device has an Input Selector feature, then make sure to change it to TV.
- When this port is used for ARC/eARC function, it can be used as signal input when a DVD is connected to an amplifier and the amplifier is connected to the TV at the same time. Some amplifiers may not support series connection.
- 5.1 CH (channel) audio is available when the TV is connected to an external device that supports 5.1 channel surround sound. You can press **Home** button to select **Settings** icon on the Home screen,

Connection



and select **Sound > Speakers > Digital Audio Output** to choose **Dolby Audio - Dolby Digital Plus** to receive the 5.1 channel audio.

Related information

[Speaker Settings](#) on page 47

Using HDMI & CEC

Use the TV remote to control external devices that are connected to the TV by a HDMI cable. The external devices need to support HDMI & CEC function.

 /  >  **Settings > System > HDMI & CEC**

Connecting an external device through HDMI & CEC function

 /  >  **Settings > System > HDMI & CEC > CEC Control**

Allow HDMI devices to control each other.

1. Set **CEC Control** to **On**.
2. Connect a HDMI & CEC compatible device to the TV.
3. Turn on the connected external device. The device will be connected to the TV automatically. After connection is completed, you can access the menu of the connected device on your TV screen using your TV remote and control the device.
4. When CEC control is enabled and HDMI & CEC compatible external devices are turned off, the TV will enter the standby mode. The function needs to be supported by the external device.

Enabling device auto power off

 /  >  **Settings > System > HDMI & CEC > Device Auto Power Off**

Set to **On** to turn off HDMI & CEC compatible external devices when the TV is turned off.



Enabling device auto power on

 /  >  **Settings > System > HDMI & CEC > Device Auto Power On**

Set to **On** to turn on HDMI & CEC compatible external devices when the TV is turned on.

This feature is applicable when TV input source is pre-set to the corresponding external device.

Enabling TV auto power on

 /  >  **Settings > System > HDMI & CEC > TV Auto Power On**

Set to **On** to turn on the TV when HDMI & CEC compatible external devices are turned on.

HDMI format function

 /  >  **Settings > System > HDMI & CEC > HDMI Format**

Please select **Enhanced format** if your HDMI device supports 4K HDR. If it does not support 4K HDR, please select **Standard format**. If you are not sure, please select **Auto**.

Note:





Connection

- HDMI cables must be used to connect HDMI & CEC compatible devices to your TV.
- The HDMI & CEC feature of the connected device must be turned on.
- If you connect an HDMI device that is not HDMI & CEC compatible, all the HDMI & CEC control features do not work.
- Depending on the connected HDMI device, the HDMI & CEC control feature may not work.
- The HDMI & CEC feature supports One Touch Play, Routing Control, System Standby, Device OSD Name Transfer, Remote Control Pass Through, Give Device Power Status, System Audio Control.

Connecting a PC or Game Console

PC

You can connect a PC to the TV with a HDMI cable to use your TV as a PC monitor.

After connecting the PC, press the  /  button, then select  **Input** icon on Home screen or press **INPUT** /  button. Select the connected PC as the input source.

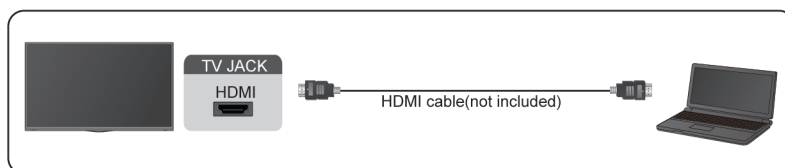





Note:

- For better image quality, set the PC's resolution, and make sure the resolution is supported by the TV.
- If there is no sound from your TV, change the PC's audio settings.
- If you want to connect your PC and TV wirelessly, please refer to [Multi-screen > Content Sharing](#) in this manual.

Game console

You can connect your game console with a HDMI cable to the TV.

To start a game from a game console:

1. Switch on your game console.
2. Press the  /  button, select  **Input** icon on Home screen or press **INPUT** /  button. Select the connected game console as the input source.
3. Start the game.





You can enable the game mode to optimise your TV's settings when playing games with a game console. For more information, please refer to [Picture and Sound > Game Mode Settings](#) in this manual.

Using External Devices

Access to connected external devices including wireless connected devices.







Connection

Switch between external devices connected to the TV



1. Press **INPUT** /  button on your remote control or press  /  button to move the focus to the  **Input** icon on the top of the Home screen, press  button to enter.
2. Select your desired input source.

Edit the name of input sources

Method 1:

1. Press **INPUT** /  button on your remote control or press  /  button to move the focus to the  **Input** icon on the top of the Home screen, press  button to enter.
2. Move the focus to an input source and press  /  button on your remote control.
3. Select **Rename**.

Method 2 (for some models):

Press  /  button on your remote control, and select  **Settings** > **System** > **Advanced Settings** > **Input Labels** to edit the name of input sources.

Note:

- Some input sources cannot be renamed.



Screen Sharing

Mirror your mobile device screen to the TV.

Before using Screen Sharing, please set your TV to the wireless network connection.

INPUT /  > **Screen Sharing**

1. Turn on the casting function of your Android/Windows 10 device. The setting icon may vary depending on the device. The feature may be called "Wireless display", "Smartview", "Wireless projection", etc.
2. Find the TV name in the search list of your device and select it. Wait for the connection progress to complete and the content on your device will be displayed on the TV.

Press  /  button on your remote control, select  **Settings** > **System** > **Mobile Device Connection** > **Screen Sharing** and switch it to on. Then, you can share your device's screen directly without opening the Screen Sharing App on your TV.

Note:

- Some mobile devices may not support casting.

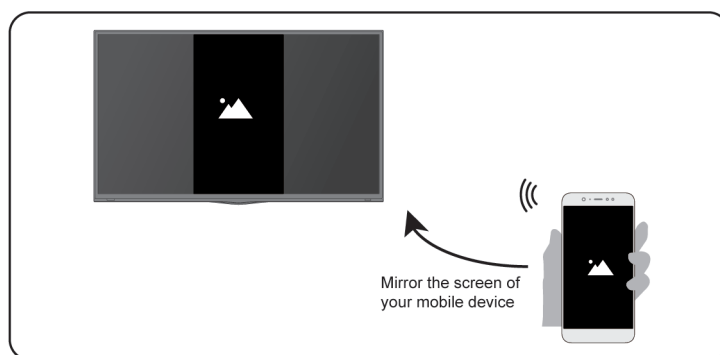



Related information

[Wireless Internet Connection](#) on page 13

Content Sharing

Content Sharing allows you to view media content, like videos, music or photos saved in your Android/iOS/PC device on your TV screen.

Sharing media content from your Android/iOS/PC device

1. Connect your TV and Android/iOS/PC device to the same network.
2. Turn on Content Sharing at  /  >  **Settings** > **System** > **Mobile Device Connection** > **Content Sharing**.
3. Turn on the content sharing function in your Android/iOS/PC device.
4. Find the TV name in the search list of your device and select it. Wait for the connection progress to complete.
5. On your Android/iOS/PC device, choose the media content you want to share on your TV.

Multi-screen

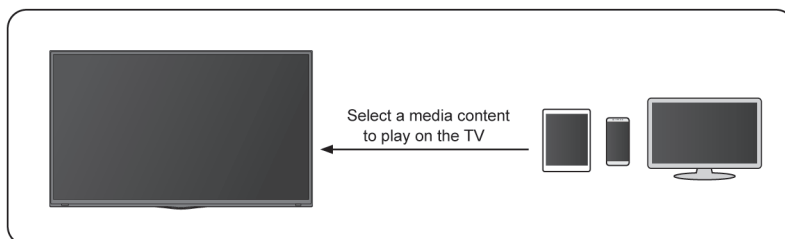

Playing media content from your Android/iOS/PC device on the TV

You can connect media content saved in your Android/iOS/PC device to your local network and play the content on your TV.

1. Connect your TV and Android/iOS/PC device to the same network.
2. Turn on Content Sharing at / > **Settings** > **System** > **Mobile Device Connection** > **Content Sharing**.
3. Make sure your media content in your Android/iOS/PC device are visible through the local network.
4. On your TV, select a device with media content at / > **Input**, or / > **More Apps** > **Media**. The media content list in your Android/iOS/PC device appears.
5. Select a media content item from the list to play.

Note:

- Some Android/iOS/PC devices may not support content sharing function. If your device does not support content sharing, you can download an app that supports the function to connect to your TV. For more information, please refer to [Smart Functions > Installing the Mobile App to Control your TV](#) in this manual.
- Content may not be played depending on the file format.
- Content may not be played smoothly, or the function may not work properly due to the network condition.



Related information

[Wired Internet Connection](#) on page 13



[Wireless Internet Connection](#) on page 13

Smart Functions

Getting Familiar with the Home Screen

Press  /  button on your remote control to enter the Home screen.

All TV functions can be accessed from the Home screen.

To exit the Home screen, press **INPUT** /  button on your remote or use the navigation buttons to move the cursor to the  **Input** icon on the top of the screen, press  button to enter, and select your desired input source.

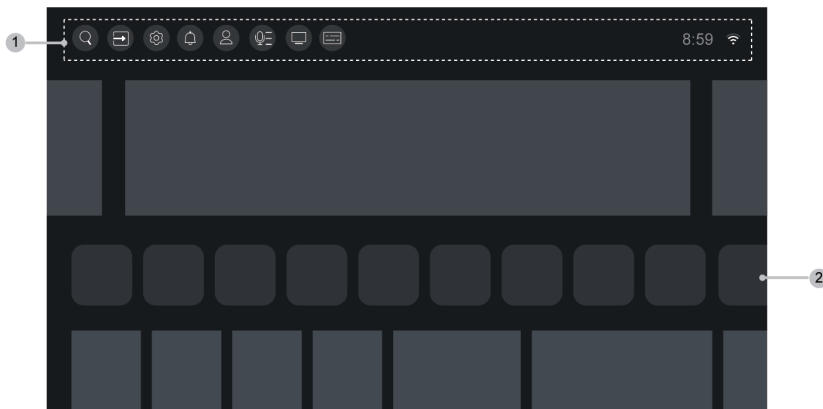

1 Navigation bar

2 Apps

Using the navigation bar

The navigation bar refers to indicators and icons on the top of the Home screen.

Note:

- Indicators or icons may vary depending on models/countries/regions.

Search

Search the content you want.

Input

Select the Input source depending on the device you have connected to your TV.

Settings

Manage TV configuration.

Notifications

Allow pop-up notifications to appear for useful information and events that occur with your TV, including:

Advertising, New Arrivals, Warnings and Legal Statements, System Messages and Alexa Notification.

You can enable/disable each of these notifications at Settings in the notification centre.

You can view the list of event messages generated by the TV.

To delete all notifications, select **Clear All**.

Smart Functions

Note:

- The Alexa Notification may not be applicable in some models/countries/regions.
- When you sign into your VIDAA account, please find Notifications in VIDAA Account on the Home screen.

VIDAA Account

Sign into your VIDAA account.

A VIDAA account provides all the best features of your Smart TV and ensures that all services are kept up to date.

For more information about VIDAA account, please refer to [Smart Functions > Using a VIDAA Account](#) in this manual.

Voice

Quick access to **Voice Service**. For more information, please refer to [Smart Functions > Using Voice Service](#) in this manual.

Guide

Quick access to Guide. For more information, please refer to [Live TV > GUIDE \(EPG\)](#) in this manual.



Live TV

Quick access to Live TV. For more information, please refer to [Connection > Connecting an Antenna](#) and [Live TV > Channel Scan](#) in this manual.

Time

You can always view the current time at the top of the Home screen.





Network

Connect your TV to the Internet through a wireless connection  or an Ethernet cable  , and the corresponding icon will appear.

Using the Shortcuts

You can add inputs, channels and websites to the Home screen to have quick access to them for your convenience.



Add inputs to the home screen

1. Press **INPUT** /  button.
2. Move the focus to an input you want to add to the Home screen, and press  /  > **Add to home** >  .
The input icon will appear in Shortcuts on the Home screen.



Note:

- Some options from Inputs source page cannot be added to the Home screen.
- To remove the input from Shortcuts, move the focus to the shortcut, then press and hold  button on your remote control.

Add channels to the home screen

1. In Live TV, press  /  button to access the channel list.

Smart Functions

2. Press  /  button and press  button to tick channel(s) that you would like to add on the Home screen.
3. Select **Add to home**. The channel icon will appear in Shortcuts on the Home screen.

Note:

- To remove the channel from Shortcuts, move the focus to the shortcut, then press and hold  button on your remote control.

Add webpages to the home screen

1. In Browser, visit a website you would like to add on the Home screen.
2. Use the D-pad to move the focus to  **menu** icon in the top of Browser navigation bar and select **Add to home**.
3. Select **Add** and this webpage will appear in the Shortcuts on the Home screen.

Note:

- To remove webpages from Shortcuts, move the focus onto the shortcut page, then press and hold button  on your remote control.
- Up to 8 webpages can be added.

Managing apps

/ > More Apps

Select the item you want to move, press and hold  button to manage, then use the D-Pad to select the desired position and press  button to store the new position.



Note:

- Some Apps may not be moved.

Using a VIDAA Account

Signing into an account

Before signing into your VIDAA account, make sure your TV is connected to the network. For more about network settings, please refer to [Connection > Wired Internet Connection](#) or [Wireless Internet Connection](#) in this manual.



1. After the network is connected, press  /  button on your remote and select  **VIDAA Account** icon in the top navigation bar on the Home screen.
2. Register your device to your VIDAA Account. After entering your E-mail and password, select **Sign In**.

Creating a new account





If you do not have a VIDAA account, create a new one to enjoy the best features of your Smart TV.

Before creating a new account, make sure your TV is connected to the network. For more about network settings, please refer to [Connection > Wired Internet Connection](#) or [Wireless Internet Connection](#) in this manual.

Smart Functions

1. After the network is connected, press  /  button on your remote and select  **VIDAA Account** icon in the top navigation bar on the Home screen.
2. Select **Create Account** on screen.
3. Enter your first name, last name, E-mail address and password. First Name and Last Name are optional.
4. Select **Create Account**.

Using Voice Service



To access the Voice Service, press  /  button on your remote and select  **Voice** icon in the navigation bar. Alternatively, just press  button on your remote.

Note:



- Voice Service feature may not be applicable in some models/countries/regions.
- To use this function, End User License Agreement and corresponding Smart feature privacy policy/terms and conditions may be required to be agreed to.

Alexa

Interact with Alexa by pressing and holding the microphone button on your remote. You can ask Alexa to control this TV.

Before setting up the Amazon Alexa Service, connect your TV to the network and sign into your VIDAA Account at  /  >  **VIDAA Account**. More information about how to sign into the VIDAA Account, please refer to [Smart Functions > Using a VIDAA Account](#) in this manual.

How to set up Alexa







1. Press  /  button to select  **Settings** icon, and select **System > Voice Service > Amazon Alexa**.
2. Select **Set voice assistant to Alexa** and **Set up now**. If you have selected Alexa in the Guide when you turn on the TV for the first time, it will directly guide you to the **Set up now** step.
3. You are now at the step 'Sign into your Amazon account'. Scan the QR code with your phone or visit the website on your phone or computer and enter the on-screen code. The code will expire after 10 minutes. If you do not have an Amazon account, create a new one.
4. After you have linked the Amazon account, the TV screen will change to the next step. You can sign into your VIDAA account. If you have signed in before, this step will be skipped.
5. Give your TV a name from the list, or you can customise it.
6. Select **Authorise** and follow the on-screen steps in Alexa Skill Setup settings.

Now Alexa is set up and ready. You can enjoy interacting with Alexa using your voice by just pressing and holding the  button on your remote control. Ask Alexa after the tone.

Note:

- The Alexa function may not be applicable in some models/countries/regions.
- The setup steps above may vary. Please refer to the specific product.
- Shipment with voice remote control varies depending on TV models/countries/regions.
- You can use Alexa without signing into your account by skipping the sign in section. In this case, you can still use your voice to change the channel and control playback. Sign into your account in the settings menu at any time to enjoy more functions of Alexa.

Smart Functions

- This feature requires Alexa built-in service. Otherwise, use external Alexa-enabled devices (e.g. Alexa App, Echo) to control your smart TV by using just your voice.
- Download and install the remote control app on your mobile device at  /  >  **Settings** > **Support** > **Mobile App Download**. Press the Microphone icon in the app to interact with Alexa on your TV.
- You can select the language used by Alexa at  /  >  **Settings** > **System** > **Voice Service** > **Amazon Alexa** > **Alexa Language**. This feature requires Alexa built-in service, which varies depending on TV models and countries/regions.







VIDAA Voice

VIDAA Voice is a voice assistant to help you control the TV and search content, supporting several languages.

Before using VIDAA Voice, please check the following:

- Network connected
- Voice remote paired
- End User License Agreement and voice feature privacy policy/terms agreed

To access the Voice Service centre and set voice assistant to VIDAA Voice, you can choose one of following options:

- Just press  button on your remote.
- Press  /  button on your remote and select  **Voice** icon in the navigation bar.
- Press  /  button to select  **Settings** icon and select **System** > **Voice Service**.

When VIDAA Voice is selected as your voice assistant, select the language of VIDAA Voice in Voice Service centre. Then, press and hold the  button on your remote to interact with VIDAA Voice.

Note:





- VIDAA Voice may not be applicable in some models/countries/regions.

Google Assistant

Setup Google Assistant and enjoy the Google Assistant service. You can ask for information, search for your favourite movies, control your TV and more, just by asking Google Assistant.

Before setting up Google Assistant, connect your TV to the network.

STEP 1: Set up Google Assistant on TV

1. Press  /  button on your remote to select  **Settings** icon, and select **System** > **Voice Service** > **Google Assistant**.
2. Set voice assistant to Google Assistant and press  button to set up. If you have selected Google Assistant in the Guide when you turn on the TV for the first time, it will directly guide you to the set-up step.
3. Then read on-screen terms of service and privacy policy, then select **I understand**.
4. Next, select **Allow** to enable information sharing.

STEP 2: Set up in Google Assistant app

Follow the setup instructions on-screen to set up Google Assistant.

1. Download and install the Google Assistant app on your mobile device, then open the app.

Smart Functions

2. Speak to Google Assistant app, "Set up my Assistant device", and follow the instruction in the App to set up Google Assistant and sign into your Google account on the TV.



Google Assistant is set up and ready. Control your smart TV using your voice by just pressing and holding the  button on your remote control.

Note:



- The Google Assistant function may not be applicable in some models/countries/regions.
- The setup steps above may vary. Please refer to the specific product.
- Shipment with voice remote control varies depending on TV models/countries/regions.
- If you do not choose to set up Google Assistant in the mobile app, just press  button to continue without signing into your Google account. You can go to TV system settings later to sign into your Google account to enjoy personal queries by asking Google Assistant, like showing your photos, calendar and more on this device.

Google Smart Home Service

For specific models and countries/regions, Google Smart Home Service function is available. Set up Google Smart Home Service to control your smart TV with Google Home devices or the App. You can change channels or inputs, adjust volume and more.

Before setting up the Google Smart Home Service, connect your TV to the network and sign into your VIDAA Account at  /  >  **VIDAA Account**. More information about how to sign into the VIDAA Account, please refer to [Smart Functions > Using a VIDAA Account](#) in this manual.

STEP 1: Set up Google Smart Home Service on TV

1. Press  /  button on your remote to select  **Settings** icon and select **System > Voice Service > Google Smart Home Service**. Select **Set up now**.
2. Sign into your VIDAA account. If you have signed in before, this step will be skipped.
3. Give your TV a name.

STEP 2: Set up in Google Home app

Follow the setup instructions on-screen to set up the Google Smart Home Service.

1. Download and install the Google Home app on your mobile device, then open the app.
2. Find and select VIDAA Voice service in the app.
3. Follow the instructions in the app to link your VIDAA account signed in on your TV to your Google Account.

Google Smart Home Service is set up and ready. Control your smart TV by using your voice through the Google Home device or App.



Note:

- Google Smart Home Service may not be applicable in some models/countries/regions.
- The setup steps above may vary. Please refer to the actual product.



Yandex Smart Home Service

Yandex Alice voice assistant can obey certain commands to help you change the TV's configuration.

Smart Functions

Before setting up Yandex Smart Home Service, connect your TV to the network and sign into your VIDAA Account at  /  >  **VIDAA Account**. More information about how to sign into the VIDAA Account, please refer to [Smart Functions > Using a VIDAA Account](#) in this manual.

STEP 1: Set up Yandex on TV

1. Press  /  button on your remote to select  **Settings** icon, then select **System > Voice Service > Yandex**. Select **Set up now**.
2. Sign into your VIDAA account. If you have signed in before, this step will be skipped.
3. Give your TV a name.

STEP 2: Set up in Yandex App

Follow the instructions on the TV to enable Yandex Smart Home Service.

1. Download the Yandex app on your mobile device.
2. Open the app and sign into your Yandex account.
3. In the Yandex app, go to "Devices" > "Smart Home", click add device icon and select "VIDAA Voice".
4. Perform account linking using the same VIDAA account signed in on your TV.



Yandex Smart Home Service is set up and ready. Now you can control your Smart TV with Yandex Alice devices or the Yandex app to change channel, change inputs, adjust volume and more, just by asking Alice.

Note:

- The Yandex function may not be applicable in some models/countries/regions.
- The setup steps above may vary. Please refer to the specific product.

Voice service other issues

If you want to turn on your TV with Alexa-enabled devices (e.g. Echo, Echo show) or Google Home devices (e.g. Google Home, Google Nest Hub), please:

1. Turn on **Wake on LAN** and **Wake on Wireless Network** at  /  >  **Settings > Network**.
2. Make sure your TV and Alexa-enabled devices/Google Home devices are connected to the same network environment.

Note:

- Only Alexa (Alexa skill is enabled) and Google Smart Home Service support turning on your TV with Alexa Echo or Google Home. Google Assistant (built-in) does not support this function.

Related information

[Wired Internet Connection](#) on page 13

[Wireless Internet Connection](#) on page 13

Media

/ > **More Apps > Media**

Media is a central location for you to view or listen to different types of content, such as photos, music and movies. You can view media content through the following methods:

- A USB thumb drive or hard drive.

Smart Functions

- Compatible mobile phone, tablet or other personal devices: you can stream movies, music and photos that are stored on compatible personal device and play or view the content on your TV.

By default, there is **Content Sharing** displayed on the Media screen. If your mobile device is connected to the TV, its name also appears on the Media screen.

For more information about **Content Sharing**, please refer to [Multi-screen > Content Sharing](#) in this manual.

Playing media contents

  > **More Apps > Media > connected devices**

Select the content you want to play on the screen, like pictures, videos and music.

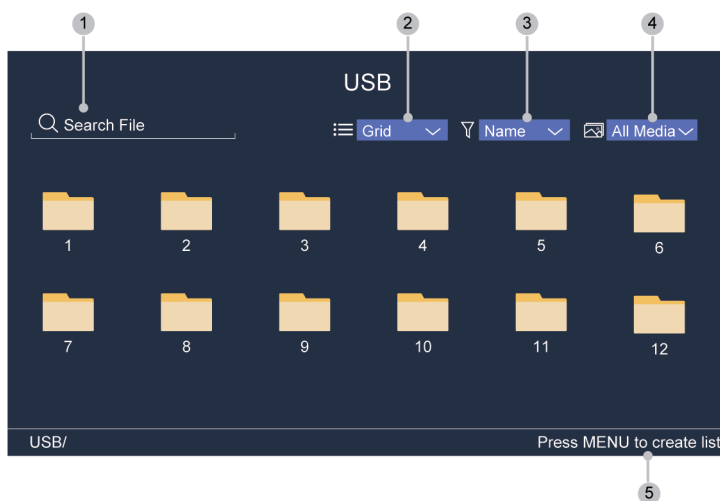



- 1 Search the content you want to play.
- 2 Arrange the content list by **Grid**, **List**.
- 3 Sort the content list by **Name**, **Date modified**, **Size**.
- 4 Filter the content list by **All Media**, **Photo**, **Video**, **Music**, **Recorded**.
- 5 Create a photo, music, or video playlist.

Note:

- Some options in the above table may not be available in some models/countries/regions.

Playing background music during viewing pictures

1. Choose a picture to display.
2. Press  /  button to call out playbar.
3. Select **Background Music** and choose your music to create a Music Playlist.

Now you can play background music while viewing pictures.

Smart Functions

Media format list

Due to differences in programming tools and other factors, some of the file formats that are listed may not be supported.

The resolution may not be supported depending on the model.

Video Format

For 4k models:

Container	Video Codec	File Extension Name	Resolution and Frame Rate
MPG	MPEG-2	.mpg .mpeg	1920 x 1080p @ 120fps
MPEG	MPEG-2		
MP4	MPEG4	.mp4	1920 x 1080p @ 120fps
	H.264(AVC)		3840 x 2160p @ 30fps
	H.265(HEVC)		3840 x 2160p @ 60fps
	AV1		3840 x 2160p @ 60fps
MOV	MPEG4	.mov	1920 x 1080p @ 120fps
	H.264(AVC)		3840 x 2160p @ 30fps
	H.265(HEVC)		3840 x 2160p @ 60fps
MKV	Mpeg2,4	.mkv	1920 x 1080p @ 120fps
	H.264(AVC)		3840 x 2160p @ 30fps
	H.265(HEVC)		3840 x 2160p @ 60fps
	AV1		3840 x 2160p @ 60fps
AVI	Mpeg2,4	.avi	1920 x 1080p @ 120fps
	H.264(AVC)		3840 x 2160p @ 30fps
FLV	H.264(AVC)	.flv	3840 x 2160p @ 30fps
	H.265(HEVC)		3840 x 2160p @ 60fps
WEBM	VP8	.webm	1920 x 1080p @ 120fps
	VP9		3840 x 2160p @ 60fps
	AV1		3840 x 2160p @ 60fps

For 2k models:

Container	Video Codec	File Extension Name	Resolution and Frame Rate
MPG	MPEG-2	.mpg .mpeg	1920 x 1080p @ 120fps
MPEG	MPEG-2		
MP4	MPEG4	.mp4	1920 x 1080p @ 120fps
	H.264(AVC)		1920 x 1080p @ 30fps
	H.265(HEVC)		1920 x 1080p @ 60fps
	AV1		1920 x 1080p @ 60fps

Smart Functions

Container	Video Codec	File Extension Name	Resolution and Frame Rate
MOV	MPEG4	.mov	1920 x 1080p @ 120fps
	H.264(AVC)		1920 x 1080p @ 30fps
	H.265(HEVC)		1920 x 1080p @ 60fps
MKV	Mpeg2,4	.mkv	1920 x 1080p @ 120fps
	H.264(AVC)		1920 x 1080p @ 30fps
	H.265(HEVC)		1920 x 1080p @ 60fps
	AV1		1920 x 1080p @ 60fps
AVI	Mpeg2,4	.avi	1920 x 1080p @ 120fps
	H.264(AVC)		1920 x 1080p @ 30fps
FLV	H.264(AVC)	.flv	1920 x 1080p @ 30fps
WEBM	VP8	.webm	1920 x 1080p @ 120fps
	VP9		1920 x 1080p @ 60fps
	AV1		1920 x 1080p @ 60fps

Audio Format

Container	Audio Codec	File Extension Name
WAV	LPCM	.wav
	ADPCM	
MP3	Mpeg1-Layer3	.mp3
	Mpeg2-Layer3	
	Mpeg2.5-Layer3	
AAC	AAC-LC	.m4a .aac
	HE-AAC(v1/v2)	
WMA	WMA	.wma
	WMA Pro	
FLAC	FLAC	.flac

Photo Format

Container	File Extension Name	Mode of Operation	Resolution
JPEG	.jpg .jpeg	-	7680 x 4320
PNG	.png	no-interlace	
		interlace	
BMP	.bmp	-	
GIF	.gif	-	
TIF	.tiff	-	

Smart Functions

Related information

[Connecting USB Devices](#) on page 16

[Media Files](#) on page 58

App



/ > More Apps

Numerous factory-installed apps are available for you to choose for your entertainment preferences.

Installing an app

Even though your TV has numerous factory-installed apps, there may be others that you would like to download.







To install an app:

1.  /  > **More Apps** > **app store**.
2. Use the navigation buttons on your remote to select the app that you want to install.
3. Select **Install**. The selected app is installed on the TV.

Note:

- To use this function, your TV must be connected to the Internet.
- Adding apps is free, but it might cost you money when using some apps.

Sorting Apps

1. In **More Apps**, select the app you want to sort, then press and hold  button to select **Sort**.
2. Press  /  /  /  button to move it.
3. Press  button to store position.

Note:

- Some Apps may not be moved.

Removing an App

You can only delete apps that you have installed to the TV. Factory-installed apps cannot be deleted.



1. In **More Apps**, select the app you want to remove, then press and hold  button to select **Remove**.
2. Select **OK**. The selected app is deleted.

Related information

[Wired Internet Connection](#) on page 13

[Wireless Internet Connection](#) on page 13

Using the Art App

Press  /  button on your remote control, and select **More Apps** > **VIDAA art**.

Numerous artworks created by global artists presented for you to browse or set as a screensaver.

Smart Functions

- Browse artworks

When you select an artwork to browse in full screen mode, press ◀/▶ button to switch artworks and press ▲/▼/OK button to display detailed information of the artwork. You can communicate with the artist using your mobile device to scan the QR code on the screen.

- Add artworks to your favourite list

Press 📖/📖 button on your remote control to add the selected artwork to your Favourite list.

- ART settings

Select ⚙️ icon in ART to set up **Time until the screen saver starts automatically**, **Picture switching time**, **Backlight** and **Screen saver selection**.

Note:

- This feature may not be applicable in some models/countries/regions.

Enjoy the Internet

Press 🌐/🏠 button on your remote control, and select **More Apps > Browser**.

You can enter websites and browse information on the Internet.

Make sure your TV is connected to the network before accessing the internet via the Browser.

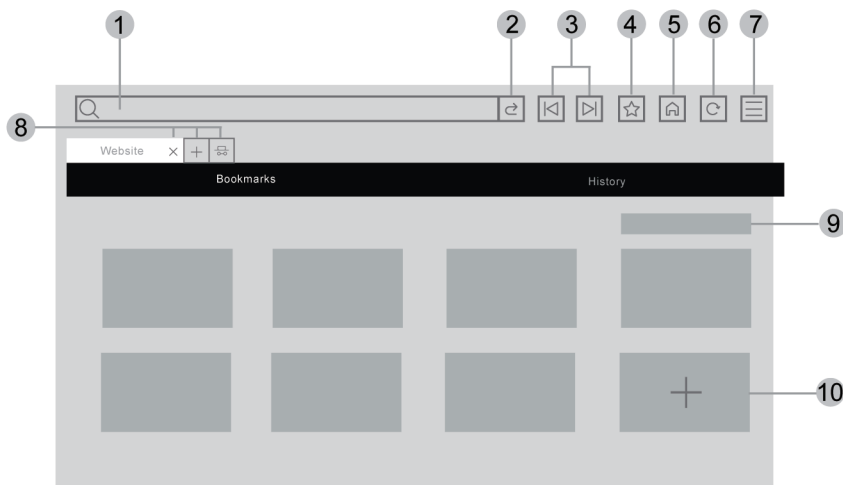

1. Enter website you want to visit
2. Visit/Search
3. Back/Forward: switch among webpages
4. Add the website you are viewing to Bookmarks
5. Back to the Homepage
6. Reload the website
7. Enter browser settings or add the website to Shortcuts on the Home screen.
8. Add/remove webpages, or add private webpages
9. Manage websites in Bookmarks
10. Add websites to Bookmarks

Smart Functions

Note:

- The image is only for reference and may differ from the actual product.
- Some contents in the Browser may not be played properly.

Related information



[Data Protection and Security](#) on page 37

[Wired Internet Connection](#) on page 13

[Wireless Internet Connection](#) on page 13



Data Protection and Security

Clear Cache

Press  /  button on your remote control and select  **Settings > System > Application Settings > Clear Cache.**

Clear cache, user data and temporary files for browser and applications.

Delete Cookies

Press  /  button on your remote control and select  **Settings > System > Application Settings > Delete Cookies.**

Delete cookies for browser and applications.

Do Not Track



Press  /  button on your remote control and select  **Settings > System > Application Settings > Do Not Track.**

Send a request to websites not to collect or track your browsing data.

Note:







- This function may not be applicable in some models/countries/regions.

Installing the Mobile App to Control your TV

Press  /  button to select  **Settings** icon, and select **Support > Mobile App Download.**

Scan the Mobile App download QR code on screen to install the app on your mobile device. It is possible to control your TV, such as turning the TV on or off, inputting characters with your mobile's keyboard and sharing pictures or videos from your mobile device to the TV. This app is available on both Android and iOS.

To connect to your TV after installing the mobile app:

1. Agree with end user license, and disclaimer and privacy policies on TV. If you are not sure whether you have agreed, check at  /  >  **Settings > Support > Disclaimer and Privacy > Data Sharing, Privacy and EULA.**
2. Make sure your mobile device and TV are connected to the same network environment.
3. To use this function, switch on **Content Sharing** at  /  >  **Settings > System > Mobile Device Connection > Content Sharing.**
4. Open the mobile app and select the TV device you want to connect.

Smart Functions

What you can do with the app:

- Turn the TV on or off
- Volume up or down
- Switch channels
- Input characters with your mobile's keyboard
- Share pictures, music, or videos from your mobile device to the TV

Related information



[Wired Internet Connection](#) on page 13

[Wireless Internet Connection](#) on page 13

Adjusting the Picture Quality

Adjust picture mode, picture size and other advanced picture settings.

Choosing a picture mode

 /  >  **Settings > Picture > Picture Mode**

Select a pre-set picture mode to best suit the content you are viewing.

Note:

- Options may differ depending on your model/country/region and the content you are watching. Please refer to the specific product.

When you use a normal signal

- **Standard**

Use Standard mode for watching normal content, such as News, Drama or Documentaries.

- **Cinema Day**

Use Cinema Day for watching movies in a bright environment.

- **Cinema Night**

Use Cinema Night for watching movies in a dark environment.



- **Dynamic**

Use Dynamic mode for content that requires vivid picture quality.

- **Sports**

Optimised picture for watching sports.

- **FILMMAKER**

Press  /  button on your remote control, select  **Settings > Picture > Filmmaker Mode Auto Detect** and turn it on. When filmmaker signal is detected, picture mode will turn to **FILMMAKER** automatically.

This function is only applicable in the HDMI input source.

Low Blue Light for TUV Certification

Cinema Day and Cinema Night are designed to reduce the level of blue light to protect your eyes.

Go to  /  >  **Settings > Picture > Picture Mode**, and select **Cinema Day/Cinema Night**.

To reduce eye strain and protect eyes when you watch TV for a period of time, you are recommended to:

- Take regular and frequent breaks, avoid watching TV for periods of more than one hour. Watching TV for long periods of time may cause eye fatigue.
- Look away from the TV screen and focus on distant objects during viewing breaks for at least 10 minutes.
- Relax yourself during viewing breaks by doing eye exercises or outdoor activities.
- The best recommended viewing distance is 3 times the vertical height of the TV screen.

Proper breaks and exercises are proved excellent help to relieve eye strain and fatigue.

Low Blue Light can only be supported when the **Colour Temperature** is set to **Warm1**.

This feature may not be applicable in some models/countries/regions. Low blue light certification may vary by model.

Picture and Sound



When you use a HDR signal

HDR (high dynamic range) can improve the viewing experience with higher contrast and vivid colours. Bright whites look brighter and dark blacks look darker. TV can display a wide range of colours.

When you use a Dolby Vision signal

Inspired by cinema technology, Dolby Vision is the format that allows your TV to deliver a full range of colours, high dynamic range images, brighter whites and dark blacks using scene-by-scene calibration.

Changing the aspect ratio

 /  >  **Settings > Picture > Aspect Ratio**

Adjust the Aspect Ratio to stretch or zoom the picture.

- **Automatic**

Automatically switch Aspect Ratio between 16:9 and 4:3 based on the signal information.

- **16:9**

Best suited for 16:9 Widescreen content. This will also stretch 4:3 content to Widescreen.

- **4:3**

Best suited for 4:3 content.

- **Panoramic**

Provide a full-screen image by stretching the edges of the picture, the middle section of the picture will not be stretched.



- **Movie Zoom**

Fill the entire screen by zooming in to remove horizontal black bars from the top and bottom of the picture.

- **Direct**

Point to point display also known as 1:1 Pixel Mapping.

Enabling Smart Scene function

 /  >  **Settings > Picture > Smart Scene**

Smart Scene will enable your TV to continually recognise the scene and enhance the picture quality on all input sources.

Note:

- Some specific applications have explicit constraints meaning content recognition is not allowed.
- When **Game Mode** or **Auto Low Latency Mode** is turned on, **Smart Scene** will be switched off automatically and is not available.

Configuring advanced picture settings

 /  >  **Settings > Picture > Picture Mode Settings**

Adjust display settings for each Picture Mode. You can personalise the picture quality by adjusting the following settings.

- **Apply Picture Settings**

Apply current picture mode settings to all the input sources or just the current source.

Picture and Sound

- **Backlight**

Set the overall brightness of the screen.

Note:

- The function name may vary depending on the model type.

The following option may differ depending on models. Please refer to the actual product.

Dynamic Backlight Control

Enhance the contrast ratio between light and dark areas of the picture.

This function may not be applicable in some models/countries/regions.

Backlight

Adjust how bright you want images to appear, lower settings create darker images (only when **Dynamic Backlight Control** is off).

This function may not be applicable in some models/countries/regions.

Automatic Light Sensor

TV will automatically adjust the picture settings according to the amount of ambient light in the room.

This function may not be applicable in some models/countries/regions.

Light Sensor Shift

This feature is adjustable only when Automatic Light Sensor is turned on. If the picture is too bright, decrease the value. If the picture is too dark, increase the value.

This function may not be applicable in some models/countries/regions.

Local Dimming (or **Dynamic Range maximum brightness** for some models)

TV will automatically adjust the backlight in specific areas of the screen according to the contrast changes in the image.

This function may not be applicable in some models/countries/regions.

- **Brightness**

Adjust the Brightness level to generate lighter or darker images.

- **Contrast**

Adjust the Contrast level to increase or decrease how bright images appear.

- **Colour Saturation**

Adjust the colour intensity of the picture for a more vibrant image.

- **Sharpness**

Adjust how sharp or soft the edges of images appear.

- **Adaptive Contrast**

Automatically adjust dark areas and light areas of the image to see more detail.

- **Ultra Smooth Motion**

Reduce the afterimage effect when viewing fast-moving objects.

This function may not be applicable in some models/countries/regions.

Picture and Sound

- **Clear Motion**

Reduce judder and blur from video content.

This function may not be applicable in some models/countries/regions.

- **Noise Reduction**

Improve the picture quality by reducing noise.

- **MPEG Noise Reduction**

Reduce MPEG block noise to provide clearer edge transitions.

- **Colour Temperature**

Adjust how warm (red) or cool (blue) the white areas of an image appears.

- **Expert Settings**

Adjust advanced picture settings based on your viewing preference.

- **Overscan**

Change the video size setting to crop the edges of the displayed image.

This function may not be applicable in some models/countries/regions.

- **Reset Current Mode**

Restore all the picture settings in the current picture mode to the factory default values.

Configuring expert settings

 /  >  **Settings** > **Picture** > **Picture Mode Settings** > **Expert Settings**

Adjust the colour space and Gamma to best suit the content you're viewing.

- **Colour Gamut**

Change the range of colours the TV displays.

This function may not be applicable in some models/countries/regions.

- **Colour Tuner**

Adjust the Hue, Saturation and Brightness of colour settings.

- **White Balance**

Adjust the intensity of red, green and blue to view the true colour of all images in the picture.

- **Black Level**

Adjust the HDMI Black Level to enhance current content.

- **Gamma Adjustment**

Adjust the Gamma to alter how the TV will respond to grayscale content. In low ambient light choose a higher number, in brighter ambient light select a lower number. The default setting of 2.2 is recommended for most ambient light conditions.

This function may not be applicable in some models/countries/regions.

- **Gamma Calibration**

Adjust selected Gamma curve.

This function may not be applicable in some models/countries/regions.

Picture and Sound

- **Viewing Angle**

Provide a better viewing experience when watching TV from anywhere in the room.

This function is only available in VAC-supported models.

- **RGB Only Mode**

RGB filter for adjustment and control of colour space and colour saturation.

- **Low Blue Light**

Eye care: reduce the emission of blue light.

This function may not be applicable in some models/countries/regions.

Panel Refresh

Perform the panel refresh function to reduce image retention effects.



Due to the optical characteristics of OLED displays, image retention may occur after the TV has been used for an extended period of time. **Panel Refresh** is recommended to correct picture quality issues and prevent image retention.

Do not remove the power plug from the socket when you want to turn off the TV. Please press the power button on the remote to turn the TV off and **Panel Refresh** will be operated automatically when the TV is in standby mode.

The power indicator light will blink when **Panel Refresh** is in progress. The whole progress will take about an hour, during the process, the screen will be turned off, once completed the TV will go to standby mode.

You could also choose to manually start **Panel Refresh**.

To manually start **Panel Refresh**:

 /  >  **Settings** > **Picture** > **Panel Refresh**

Red flashing light indicates **Panel Refresh** in progress.

Note:



- This function is only available for OLED models.

 **Related information**

[Picture Issues](#) on page 55

Game Mode Settings

Enabling game mode

 /  >  **Settings** > **Picture** > **Game Mode**

Enable **Game Mode** to optimise the TV's settings to enjoy a better gaming experience with a PC or a game console connected to the TV.

Game Mode will allow:

- Reducing input lag to make sure every press or click matches what is happening on the screen;
- Improving responsiveness to produce very little motion blur;
- Processing YUV 4:4:4 format signals precisely to present accurate image colours.

Note:

Picture and Sound

- This function may not be applicable in some input sources or applications.

Enabling auto low latency mode

 /  >  **Settings** > **Picture** > **Auto Low Latency Mode**

Enjoy a smooth viewing experience with external devices connected to the TV when **Auto Low Latency Mode** is enabled.

Note:

- This function may not be applicable in some input sources or applications.
- When **Game Mode** is enabled, **Auto Low Latency Mode** will be switched off automatically and is not available.



Related information

[Connecting a PC or Game Console](#) on page 21

Adjusting the Sound Quality

Adjust sound mode and other advanced sound settings.

Choosing a sound mode

 /  >  **Settings** > **Sound** > **Sound Mode**

Select a pre-set sound mode to suit the content you are listening to.

- **Standard**

In Standard mode, the TV delivers a flat frequency response, which preserves the natural characteristics of the original sound.

- **Theatre**

Theatre mode increases the surround sound effect and provides a more prominent bass response.

- **Music**

In Music mode, low and high frequencies are emphasised to enhance musical instrument reproduction.

- **Speech**

In Speech mode, low and high frequencies are attenuated to improve the reproduction and clarity of the human voice.



- **Late Night**

In Late Night mode, the TV will improve the reproduction and clarity of the human voice with a low volume level.

- **Sports**

Optimised sound for watching Sports events.

Dolby Atmos

 /  >  **Settings** > **Sound** > **Dolby Atmos**

Set Dolby Atmos to **On** to enhance the richness of sound allowing a more immersive listening experience.

This function may not be applicable in some models/countries/regions.

Audio Enhancement

 /  >  **Settings** > **Sound** > **Audio Enhancement**

Set **Audio Enhancement** to allow the audio experience to be provided by Dolby Atmos or DTS Virtual X. Enable or disable according to your own preference.

This function may not be applicable in some models/countries/regions.

Configuring advanced sound settings

 /  >  **Settings** > **Sound** > **Sound Mode Settings**

Adjust the audio settings of the TV. You can personalise the sound quality by adjusting the following settings.

- **Apply Audio Settings**

Adjust current sound mode to apply to all sources or just the current source.

- **Total Sonics**

Optimise the overall sound quality by increasing bass and widening the sound field to provide a clear, natural dialogue.

This function may not be applicable in some models/countries/regions.

- **Total Volume**

Maintain a consistent loudness level for a wide dynamic range of programmes, loud commercials and channel or input changes.

This function may not be applicable in some models/countries/regions.

- **Total Surround**

Provide surround sound experience with psycho-acoustic processing to place sounds at the side, behind and above the viewer. For best results use with Total Sonics.

This function may not be applicable in some models/countries/regions.

- **Bass Boost**

Bass Boost uses DTS TruBass™ to enhance the perception of bass frequencies to provide deep, rich bass response from the TV's internal speakers.

This function may not be applicable in some models/countries/regions.

- **Surround Sound**

Surround sound uses DTS TruSurround™ to deliver an immersive surround sound experience from the TV's internal speakers.

This function may not be applicable in some models/countries/regions.

- **Dialog Clarity**

Dialog Clarity uses DTS Dialog Clarity™ to boost the frequency range of the human voice so dialogue is clearly understood and heard above audio or surround effects.

This function may not be applicable in some models/countries/regions.

- **TruVolume**



Automatic control over large volume changes while watching TV programmes or films, providing a more comfortable and consistent volume.

This function may not be applicable in some models/countries/regions.

Picture and Sound

- **Equalizer**

Boost the volume at different frequencies.

This function is only applicable when **TV Speakers** is selected at  /  >  **Settings** > **Sound** > **Speakers** > **Audio Output**.

- **Subwoofer**

Enable / Disable internal subwoofer.

This function may not be applicable in some models/countries/regions.

- **Bass Boost Value**

Built-in bass adjustment.

This function may not be applicable in some models/countries/regions.

- **Wall Mount Setup**

Automatically optimise the sound based on the position of the TV.

This function may not be applicable in some models/countries/regions.

- **Auto Volume Control**

Activate to prevent the volume from changing when switching TV channels.

This function may not be applicable in some models/countries/regions.

- **Reset Current Mode**

Restore all of the audio settings in the current audio mode to the factory default values.

Note:

- Some models may not support decoding of DTS CD bitstreams. Playback of this format may produce undesirable noise.

 **Related information**



[Sound Issues](#) on page 55

SoundBar Settings

 /  >  **Settings** > **Sound** > **Sound Bar Settings**.

When a soundbar device is connected to the TV, you can change the **Sound Bar Settings** via the Settings menu for best device audio quality.

When an ARC device is connected to the TV, the sound output is automatically switched to ARC. If the user switches to other sound output channels, the soundbar menu cannot be adjusted but the sound menu of TV can be adjusted.

When you connect a soundbar with a HDMI cable, you should Set **CEC Control** to **On** by pressing  /  button on your remote control, then select  **Settings** > **System** > **HDMI & CEC** > **CEC Control**.

- **EQ Modes**

You can select **Music**, **Movie**, **News**, **Sport**, **Night**.

- **Surround Modes**

You can set to **On** to turn on the Surround Modes.

Picture and Sound

- **Bass Level/Treble Level/Dimmer Level**

You can adjust **Bass Level/Treble Level/Dimmer Level**

- **Reset**

Reset current Sound Bar Settings to factory mode.

Note:

- This function is only applicable for the specific soundbar types.

Speaker Settings

 /  >  **Settings** > **Sound** > **Speakers**

Adjust the settings of speakers.

Audio Output



Select the speakers which you want to use.

Digital Audio Output

Select the digital audio output format that best suits the audio device type.

- **Auto:** the audio device automatically outputs in a supported format.
- **Pass Through:** the audio device outputs without any processing.
- **PCM:** the audio device outputs PCM (pulse code modulation) format.
- **Dolby Audio - Dolby Digital:** the audio device outputs Dolby Digital audio when connected to the TV via the optical port.
- **Dolby Audio - Dolby Digital Plus:** the audio device outputs Dolby Digital Plus audio when connected to the TV via the HDMI (ARC/eARC) port.

Note:

- This function is only applicable when  /  >  **Settings** > **Sound** > **Speakers** > **Audio Output** is set to **ARC** or **SPDIF Only**.
- When external audio devices are connected to the TV via optical, **PCM** and **Dolby Audio - Dolby Digital** are recommended.

Digital Audio Delay

Adjust the digital audio output delay time to sync audio from an external speaker with the images on the TV.

This function is only applicable when  /  >  **Settings** > **Sound** > **Speakers** > **Audio Output** is set to **ARC** or **SPDIF Only**.

Lip Sync

Synchronise the video and audio.

This function may not be applicable in some Audio Output modes.

Balance



Adjust the left and right speaker level to optimise audio for a specific location.

Picture and Sound

This function may not be applicable in some Audio Output modes.

This function is not applicable when **Dolby Atmos** is turned on.

eARC

Connect an audio device that supports eARC via HDMI (eARC), set **eARC** to **On** to enjoy higher sound quality. This feature is available to set when  /  >  **Settings** > **Sound** > **Speakers** > **Audio Output** is set to **ARC**.



This function may not be applicable in some models/countries/regions.

Related information

[Connecting Speakers or Other Audio Receivers](#) on page 18

[Connecting a Digital Audio System with ARC/eARC](#) on page 19

Using Headphones

 /  >  **Settings** > **Sound** > **Headphone**

Set the sound output mode through headphones.

After connecting your wired or Bluetooth headphone, or other external audio amplifiers, you can set up your TV to your preference.

This function may not be applicable in some models/countries/regions.

Headphone Mode

Change Headphone audio settings.

Headphone Only, the TV speakers will be muted when the headphones are being used. Any other connected audio devices will also be muted when headphones are in use.

Headphone with Speakers, the TV speakers, headphones and other connected audio devices will have audio output.

Audio Out with Speakers, the TV speakers and headphones will have audio output simultaneously, and the volume can be adjusted simultaneously.

Note:

- When you set built-in speakers and earphones to have audio output at the same time, the sound effect of the speakers may change.

Headphone Volume

Independently adjust the volume of the Headphones.

In **Headphone Only** mode, you can adjust the volume by the remote or in Headphone Volume menu on screen.

In **Headphone with Speakers** mode, the TV speaker volume can be adjusted by the remote. The volume of headphone can be adjusted in Headphone Volume menu on screen.

Related information

[Connecting Bluetooth Devices](#) on page 14

[Connecting Headphones](#) on page 16

[Connecting Speakers or Other Audio Receivers](#) on page 18

Accessibility

 /  >  **Settings > Accessibility**

Accessibility function provides menu options and audio description to aid the visually or hearing impaired.

- **Menu Scheme**

Select menu scheme style from **Dark, Light**.

- **High Contrast Menu**

Improve contrast for visually impaired.

- **Menu Transparency**

Select menu transparency from **Off, Medium, High**.

- **Audio Type**

Audio Type

Accessibility audio settings.

Audio Format

Select the audio format.

Fader Control

Provide the best sound quality options for the visually impaired.

Note:

- The above functions may not be applicable in some models/countries/regions.

- **Subtitle Settings**

Adjust Subtitle Settings for digital broadcast content.

Subtitle

Enable Subtitle type.

Primary Subtitle

Set the default subtitle language for digital broadcast content.

Secondary Subtitle

Set the secondary subtitle language for digital broadcast content.

Channel Subtitle Storage

Enable the storage of subtitle settings per channel.

Note:

- The above functions may not be applicable in some models/countries/regions.

Setting Time

 /  >  **Settings > System > Time**

Set the current time based on your location.

- **Time Format**

Set the time display to be 12 or 24-hour format.

Accessibility and System

- **Date/Time**

Set the Date and Time. You can set the date and time to automatically sync with Internet/broadcast or manually setup by yourself.

This function may not be applicable in some models/countries/regions.

- **Time Zone**

Select your time zone.



This function may not be applicable in some models/countries/regions.

- **Daylight Saving**

Select whether to apply Daylight Saving Time to the TV.

This function may not be applicable in some models/countries/regions.

Using Timer

 /  >  **Settings > System > Timer Settings**

Adjust the timer settings to suit your preference.

- **Sleep Timer**

Set the sleep timer to automatically turn the TV off at the specified time.

- **Power On Timer**

Set the time you want the TV to turn on automatically. You can set the same time each day or set a different time on different days.

- **Power Off Timer**

Set the time you want the TV to turn off automatically. You can set the same time each day or set a different time on different days.

- **Menu Timeout**

Set the amount of time you would like the menu to remain on the screen.

- **Auto Sleep**

Set the amount of time that you would like the TV to auto power off after a period of no activity.

This function may not be applicable in some models/countries/regions.

- **Auto Standby with No Signal**

TV will go to standby if there is no signal after the set time.

Using Parental Controls

 /  >  **Settings > System > Parental Control**

Turn on Parental Control to prevent children from being able to view certain content.

If you have not set the PIN code before, create and confirm PIN window will be displayed. Using the D-pad on the remote, create the PIN code.

If you have set the PIN code before, enter PIN window will be displayed.

Set PIN code at  /  >  **Settings > System > System PIN.**

Accessibility and System

- **Locks**

Turn on Locks to enable the Parental Control function.

You will see other Parental Control settings change from a greyed out state to highlighted. When this occurs, **Block Time**, **Channel Block**, **Content Block**, **Input Block**, **App Block**, or **Reset to Default** features are available to set.

- **Block Time**

Block the whole TV usage for a defined period of time, including Live TV, HDMI and apps.

- **Channel Block**

Block all or individual channels when you turn on the Parental Control feature.

- **Content Block**

Certain programmes are blocked by age rating. This is controlled by the broadcaster.

- **Input Block**

Block content from devices that are connected to external inputs.

- **App Block**

Block access to certain apps.

- **Reset to Default**

Restore Parental Control back to the factory default setting.

Setting Language and Location

 /  >  **Settings > System > Language and Location**

Select the language used for this TV and your location.

- **Location**

Choose the location from where you will watch your TV.

- **Postcode**

User can change the Postcode. This function may not be applicable in some models/countries/regions.

- **Menu Language**

Set the default language for the TV menu.

- **Primary Audio**

Set the default audio output language for the type of digital broadcast content that you are viewing.



- **Secondary Audio**

Set the secondary audio output language for digital broadcast content.

- **Digital Teletext**

Adjust Teletext decoding.

Setting Power Indicator Mode

 /  >  **Settings > System > Advanced Settings > Power Indicator**

Set the power indicator display to stay On or Off when in Standby mode.

 /  >  **Settings > System > Advanced Settings > Indicator Light Setting**

Accessibility and System

Set the indicator light from **Power**, **Always** or **Off**.

Note:

- The above functions may not be applicable in some models/countries/regions.

Screen Magnification



 /  >  **Settings** > **Accessibility** > **Screen Magnification**.

Allow visually impaired/partially sighted viewers to magnify an area of the screen.

Note:

- This function is only applicable for some scenarios.
- This function may not be applicable in some models/countries/regions.



Setting Usage Mode

 /  >  **Settings** > **System** > **Advanced Settings** > **Usage Mode**

Set the TV to use in Home or Store mode.



- **Home Mode**





Select Home Mode for normal TV usage.

If you want to switch to Store Mode when the TV is in Home Mode, press  /  button to select  **Settings**, and select **System** > **Advanced Settings** > **Usage Mode**, and choose **Store Mode**.

- **Store Mode**

Select Store Mode to setup the TV in a retail setting. This mode enables E-Pos and other demo functions and is only intended for use in retail stores.

When Store Mode is selected, press  /  button on your remote control to enter store mode settings.

If you want to switch to Home Mode when the TV is in Store Mode, press  /  button on your remote control to enter store mode settings and choose **Home Mode**. Alternatively, press  /  button to select  **Settings**, and select **System** > **Advanced Settings** > **Usage Mode**, and choose **Home Mode**.

Note:

- Enabling Store Mode could increase energy consumption.
- How to exit Store Mode varies depending on models/countries/regions.

Using Remote Control Service

 /  >  **Settings** > **Support** > **Remote Control Service**

Remote Control Service enables your TV to be controlled from the client server to allow service agents to diagnose the problem of your TV and deal with the problem online efficiently.

To use this function:



1. Turn on **Remote Control Service**.
2. Select **Agree All** and **Confirm** in End User License Agreement page.
3. Select **Generate PIN** in Remote Control Service.
4. You can initiate a help request to a service agent by the hotline and provide the on-screen PIN.

Note:

- This function may not be applicable in some models/countries/regions.
- Steps above may vary. Please refer to the specific product.
- Keep the network connected when the Remote Control Service is running.

Checking the Software Version

To check the current software version of your TV:

Access  /  >  **Settings** > **Support** > **System Info** > **Version**.

Software Upgrade

 /  >  **Settings** > **Support** > **System Upgrade**

Set your TV to receive the latest firmware.

- **Auto Firmware Upgrade**

Set your TV to automatically receive the latest firmware.

- **Check Firmware Upgrade**

Check to ensure that your TV has received the latest firmware.

Please ensure your TV is connected to the Internet.

- **Check OAD Upgrade**

Check to ensure that your TV has received the latest firmware via the tuner.

Note:

- Please ensure your TV is connected to the Internet.
- This function is only applicable when Thailand and Malaysia are selected in Location.
- **System App Auto Upgrade**
Set your system applications to automatically upgrade to the latest version. App auto upgrade will be completed in the background. Confirmation on new Privacy Notices may be required to complete any upgrades.
- **Upgrade from USB**
Upgrade TV software from USB device.

Note:



- Please ensure the USB flash drive is inserted to the USB 2.0 port of the TV.
- The update files must be located in the root directory of the update USB device.
- The format of the USB must be FAT32 and the partition table type must be MBR.

 **Related information**

[Connecting USB Devices](#) on page 16

HbbTV

Access service from providers through HbbTV.

 /  >  **Settings** > **System** > **Application Settings** > **HbbTV**

Enable or disable HbbTV functionality for all channels (only available for digital channels).

Accessibility and System

In Live TV, press /  button to select **HbbTV**.



Enable or disable HbbTV functionality for the current channel (only available for digital channels).

When HbbTV service is enabled and the programme supports HbbTV, follow the instructions on the TV screen to select the corresponding button on the remote control to access the service.

Note:

- This function may not be applicable in some models/countries/regions.
- Some channels may not support the HbbTV service.
- HbbTV cannot be used during Timeshift or PVR.

Setting the TV Name



 /  >  **Settings** > **System** > **Advanced Settings** > **TV Name**

You can edit the name for your TV to be used on the network.

Note:

- Up to 18 characters can be entered.

Enjoying Safe Use of the TV

 /  >  **Settings** > **Support** > **Disclaimer and Privacy** > **Data Sharing, Privacy and EULA**.



Read the Disclaimer Details and Data Protection Policy. Allow/Deny your consent to the listed policies relating to the collection of User/Network data.

 /  >  **Settings** > **Support** > **Disclaimer and Privacy** > **Remove User Data**.

To remove any usage data from the local TV and Cloud storage, select **Remove User Data**.

Checking the TV Running Time

You can access the Status Check page to view the running time of your TV.

1. In Live TV, press /  button to launch the quick menu.
2. Under the quick menu, press and hold  [BLUE] button, the Status Check page will appear on screen for you to check the TV running time.

Note:

- This feature may not be applicable in some models/countries/regions.

Reset to Factory Default

 /  >  **Settings** > **Support** > **Reset to Factory Default**

Restore your TV to the factory default. Reset will clear your personal settings, information and data. Enter the PIN code on-screen to enable the Factory Reset.

Troubleshooting









Picture Issues

When the TV has a picture problem, these steps may help resolve the problem.

 /  >  **Settings** > **Support** > **Self Diagnosis** > **Picture Test**

Before you review the list of problems and solutions below, use **Picture Test** to determine if the problem is caused by the TV. **Picture Test** displays a high definition picture that you can examine for flaws or faults.

- If the test picture does not appear or there is noise or distortion, the TV may have a problem. Contact the service company in your country/region.
- If the test picture is displayed properly, there may be a problem with an external device. Please check the connections.
- If the problem persists, check the signal strength or refer to the external device's user manual.

Problem	Possible Solutions
No picture, or black and white picture.	<ul style="list-style-type: none">• Unplug the TV power cord from AC outlet and re-plug after 60 seconds.• Check if the Colour Saturation is set to 50 or higher at  /  >  Settings > Picture > Picture Mode Settings > Colour Saturation.• Try different TV channels.
The picture is distorted.	<ul style="list-style-type: none">• The compression of video content may cause picture distortions, especially in fast moving pictures from sports programmes and action movies.• If the signal reception is weak or poor, screen distortion may be visible but it is not a malfunction.• Mobile phones used close to the TV (within 1m) may cause noise on analogue and digital channels.
The picture is blurry or flickering, or cuts out momentarily.	<ul style="list-style-type: none">•  /  >  Settings > Picture > Picture Mode Settings > Sharpness. You can try to increase or decrease the Sharpness.• If you use an external antenna, check the direction, position and connection of the antenna.• Adjust the direction of your antenna, or reset or fine tune the channel.
The picture appears red, purple, pink and other colours.	<ul style="list-style-type: none">•  /  >  Settings > Picture > Picture Mode Settings > Expert Settings > White Balance. You can try to increase or decrease the White Balance.
Picture distorted or appear wavy.	<ul style="list-style-type: none">• Some electrical appliances may affect the TV. If you turn off the appliance and the interference goes away, then move it further away from TV.• Insert the power plug of the TV into another power outlet.

Sound Issues

When the TV has a sound problem, these steps may help resolve the problem.

 /  >  **Settings** > **Support** > **Self Diagnosis** > **Sound Test**



If the TV plays the **Sound Test** melody without distortion, there may be a problem with an external device or the broadcast signal's strength.

Troubleshooting



Problem	Possible Solutions
There is no sound or the sound is too low at maximum volume.	<ul style="list-style-type: none"> Check the volume control of the device (cable or satellite box, DVD, Blu-ray, etc.) connected to your TV.
Picture is normal, but no sound.	<ul style="list-style-type: none"> Check the volume settings. Check if 'Mute' mode is set to on.
The speakers are making an odd sound.	<ul style="list-style-type: none"> Make sure that the audio cable is connected to the correct audio output connector on the external device. For antenna or cable connections, check the signal information. A low signal level may cause sound distortions.
Sound distorted or appears wavy.	<ul style="list-style-type: none"> Some electrical appliances may affect the TV. If you turn off the appliance and the interference goes away, then move it further away from TV. Insert the power plug of the TV set into another power outlet.
Sound is blurry or cuts out momentarily.	<ul style="list-style-type: none"> If you use an external antenna, check the direction, position and connection of the antenna. Adjust the direction of your antenna or reset or fine tune the channel.

Network Issues

When the TV has difficulties in connecting to the Internet, these steps may help resolve the problem.

 /  >  **Settings** > **Support** > **Self Diagnosis** > **Network Test**

If the TV network is connected, the screen will display Connected successfully.

Problem	Possible Solutions
The TV cannot connect to your network or apps.	<ul style="list-style-type: none"> Make sure the TV has a network connection. Run  /  >  Settings > Support > Self Diagnosis > Network Test. Contact your Internet service provider.
The wireless network connection failed.	<ul style="list-style-type: none"> Make sure your wireless modem/router is on and connected to the Internet.
The wireless network signal is too weak.	<ul style="list-style-type: none"> Position your wireless router, modem router, or access point in a central location. Avoid putting it in a corner.

External Device Connection Issues

When the TV has difficulties with external device connection, these solutions may help resolve the problem.

Problem	Possible Solutions
I have connected an external source to my TV but I get no picture and/or sound.	<ul style="list-style-type: none"> Check whether the connection between the external device and your TV is correct. Make sure you have made the correct selection of input source.

Troubleshooting

Problem	Possible Solutions
The TV is having trouble receiving a signal from an external set top box.	<ul style="list-style-type: none"> If there is no signal occasionally, unplug cable from TV and re-plug after 60 seconds. If there is always no signal, or the signal cannot be restored after plugging and unplugging, you can try / > Settings > System > HDMI & CEC > HDMI Format, to confirm whether the signal can be recognised. Change to another HDMI port. Change to another HDMI cable.
There is no sound.	<ul style="list-style-type: none"> Check whether ARC is selected at / > Settings > Sound > Speakers > Audio Output. If not, you need to check whether the external power amplifier device is connected to the ARC/eARC port or optical port of the TV. / > Settings > Sound > Speakers > Digital Audio Output. You can try to select PCM, Dolby Audio - Dolby Digital, or Dolby Audio - Dolby Digital Plus. Whether the power amplifier device port is connected correctly. If you select HDMI as input, you can try / > Settings > System > HDMI & CEC > HDMI Format.
The remote control does not work.	<ul style="list-style-type: none"> Confirm that TV still has power and is operational. Replace the batteries in the remote control. Check if the batteries are correctly installed. If some buttons do not work, but the volume buttons can work normally, there may be a problem with the application.

Note:

- Keyboards connected via USB or Bluetooth technology may not be usable with some Apps.

HDMI & CEC Issues

When HDMI & CEC is not working, these steps may help resolve the problem.

Problem	Possible Solutions
HDMI & CEC does not work.	<ul style="list-style-type: none"> Confirm that the device is a HDMI & CEC compatible device. Check if the power cable of the HDMI & CEC device is properly connected. Check the cable connection of the HDMI & CEC device is secure. Check HDMI & CEC feature of your TV is turned on. <p>Press / button on your remote control and select Settings > System > HDMI & CEC > CEC Control.</p> <ul style="list-style-type: none"> Check HDMI & CEC feature of the connected device is turned on. Depending on the connected HDMI device, the HDMI & CEC control feature may not work.

Troubleshooting

☰ Related information

[Using HDMI & CEC](#) on page 20

Media Files

When files will not play, this may help resolve the problem.

Problem	Possible Solutions
Some files cannot be played.	<ul style="list-style-type: none">Most files can be played back, but you might experience problems with corrupted files or files with high-bitrate, unsupported resolution, unsupported container or codec formats.

☰ Related information

[Media](#) on page 31

Voice Service Issues

When some Voice service will not function, this may help resolve the problem.

Problem	Possible Solutions
Alexa cannot be heard.	<ul style="list-style-type: none">You can try to log into your Amazon account.If you hear "I don't understand" from the voice recognition, please change account or log out of the account.For more information about Alexa, please refer to Smart Functions > Using Voice Service > Alexa in this manual.
Google assistant cannot be heard.	<ul style="list-style-type: none">You can try to log in Google account.If you receive "I don't understand" of the voice recognition, please change account or log out the account.After logging in to the Google account, the recognition language may be different. You need to log in to the Google account on the web page to set the voice language.For more information about Google Assistant, please refer to Smart Functions > Using Voice Service > Google Assistant in this manual.

TV Status Diagnosis

🏠 / 🏠 > ⚙️ [Settings](#) > [Support](#) > [Self Diagnosis](#)

When the TV malfunctions, you can perform some self-diagnosis to find the problem.

• Picture Test

When performing the Picture Test, a test picture will be shown on screen. Select OK to start the test. Picture Test displays a high-definition picture that you can examine for flaws or faults. Please check the picture carefully in the next 10s.

• Sound Test

When performing the Sound Test, a test sound will be played with the TV Speaker. Select OK to start the test. Please listen to the sound carefully to check whether you can hear the sound problem.

Troubleshooting

- **Network Test**

When performing a Network Test, the test will confirm whether your TV is connected to network via the TV screen. If the network test is successful but you still have problems using online services, please contact your Internet provider.

- **Bandwidth Monitoring**

Test the speed with a third-party website.

- **Input Connection Test**

When performing an Input Connection Test, you can select from the input sources and check related information with external connections.

- **Status Check**

When performing a Status Check, the status of your TV will be displayed showing any error codes.

Recording/Timeshift Issues

When **Timeshift** or **Schedule recording** is not working, these steps may help resolve the problem.

Problem	Possible Solutions
Schedule Recording cannot be used.	<ul style="list-style-type: none">• Check if there is a storage device connected to the TV.• Check the free space of the storage device. The function will not work if there is not enough storage space on the device.• Check whether your storage device is damaged. If so, it is suggested to format your storage device.• Recording will automatically stop if the signal becomes too weak.• Recording or Timeshift function may not work if the read/write speed of the USB device is too slow.• Recording or timeshift function may not work because the storage format of your device is unsupported.

- The Recording/Timeshift functions may not be applicable in some models/countries/regions.

Related information

[PVR](#) on page 8

[Timeshift](#) on page 11

Other Issues

Use these procedures to resolve other issues that may occur.



Problem	Possible Solutions
The TV is hot.	<ul style="list-style-type: none">• Watching TV for an extended period of time causes the panel to generate heat. The heat from the panel is dissipated through internal vents running along the top of the TV.• After extended use, you may feel heat when touching it. This heat is not a defect and does not affect the TV's functionality.
The TV smells of plastic.	<ul style="list-style-type: none">• This smell is normal and will dissipate over time.

Troubleshooting

Problem	Possible Solutions
The plastic cabinet makes a "clicking" type of sound.	<ul style="list-style-type: none">• The "clicking" sound can be caused when the temperature of the TV changes. This change causes the TV cabinet to expand or contract, which makes the sound. This is normal and the TV is OK.
When I turn on my TV, there is a delay for a few seconds before the picture appears. Is this normal?	<ul style="list-style-type: none">• Yes, this is normal. The TV is initialising and searching for the previous setting information.

Using the E-Manual

Launching the E-Manual

 /  >  **Settings** > **Support** > **E-Manual**

View the embedded E-Manual that contains information about your TV's key features.

- The black background icon stands for the button on the remote control.
- The grey background icon stands for the icons on the device for selecting.

Disclaimer:

Instructions and images through this manual are only for reference and may differ from the actual product.

Using the buttons in the E-Manual

Search

Search for the product feature information, the E-Manual will provide all the titles and content that contains the search information.

QR Code

Scan the QR Code with your Smart Phone to Open the E-Manual on your device.

Try Now button

Select **Try Now**, and it will guide you to the corresponding TV menu for trying the function.

Guidelines

Note:

- Guidelines content is only applicable in Germany.

How are TV channels sorted and why?

Channel sorting

The availability of individual channel may depend on the selected reception path, such as satellite (DVB-S/S2), cable (DVB-C) or antenna (DVB-T2) and the signal strength.

Standard or an operator (Astra 19.2°, Vodafone (NRW, Hessen, BW) or Pjur) can be selected for automatic channel search.

To sort channels when selecting an operator:

When an operator is selected, the channels are sorted based on the operator's criteria.

Channel sorting when selecting **Standard**:

After a successful channel search, the channels are sorted by genre. These include full programmes, children, sports, documentaries, or regional and local programmes.

Broadcasters with less coverage and, if available, international channels are listed in alphabetical order after the pre-sorted list.

If LCN (Logical Channel Number, only possible with cable reception) is activated during the channel search, the sorting takes place according to the criteria of the local cable network operator.

Using the E-Manual

Search by Channel name

The search within Live TV can be opened with the  button. Here you can search for individual channels by name.

Radio Transmitter

Radio channels are listed in alphabetical order after the list of TV channels.

To make finding radio channels easier, the filter function of the channel list is recommended (please refer to Channel List in this manual).

Sponsored Content

On the basis of bilateral contracts with the respective broadcasters, individual channels are placed in a position defined by the broadcaster in the channel list.

Sort Manually

The channel list can be manually sorted at any time. More information can be found in Channel Edit and Favourite in this manual.

How are apps sorted and why?

The applications on the VIDAA platform are positioned according to the bellow criteria.

In the Application Docker on the Home Launcher:

To ensure equal representation of apps and provide fair treatment of newly launched content partners, the applications are ordered based on the (i) global number of users, (ii) number of users in Germany, (iii) number of subscribers in Germany, (iv) share of local language content, (v) variety of content, and (vi) novelty of the platform. At all times the Application launcher must include:

- the 2 leading global SVOD platforms
- the 2 leading global TVOD platforms
- the 2 leading global AVOD platforms
- the leading local sports platform
- at least 4 leading local applications with predominantly German content
- at least 1 leading application with children's content
- at least 2 applications that have launched in the last 6 months



The ordering of applications is reviewed every 6 months and a new programming table is issued for newly connected devices.

In the My Apps section:

The applications are ordered in alphabetical order.

How can TV channels and apps be customised?

TV channels

In Live TV, press  /  >  to select a Live TV channel category such as Antenna or Cable, use D-pad to select **Edit**.

Using the E-Manual

Alternatively, in Live TV, press / button, select **Settings > Channel > Channel Edit**, and select a Live TV channel category such as Antenna or Cable.

- Press button on the selected channel, a checkbox will appear. You can select multiple channels at the same time to move or delete.
- Move: Press button to move the selected channel.

Moving the channels could be restricted by the operator. If you want to be able to move channels, it is recommended not to choose an operator during channel scan, LCN should be set to **Off**.

- Delete: Press button to delete the selected channel.
- Restore: Press [RED] button, or press / button to display the colour menu and select RED to enter the list of deleted channels. Press button to restore the deleted channel.
- Filter: Press [YELLOW] button or press / button to display the colour menu and select YELLOW, the filter screen will pop up. Press button to select options, the channel list can be updated.
- Search: Press [BLUE] button or press / button to display the colour menu and select BLUE to search the channel.

Favourite list

Viewing your favourite list

In Live TV, press / > > **Fav** to display the favourite list. A heart-shaped icon appears next to your favourite channel.

Editing the favourite list

In Live TV, press / > > **Fav** > to select **FAV1 - FAV4**, then use D-pad to select **Edit**.

Alternatively, go to / > **Settings > Channel > Channel Edit**, and select **FAV1 - FAV4**.

You can add, move or remove favourite channels.

- Select **Add channels** to add the selected channel to the favourite list.
- Select a channel in a favourite list, press button to move it.
- Select a channel in a favourite list, press button to remove it.

Apps

/ > More Apps

Factory installed apps:

Select the item you want to move, press and hold the button, use the D-pad to move it, then press button to store position.

Non-factory installed apps:

Select the item you want to move, press and hold the button to select **Sort**, use the D-pad to move it, then press button to store position.

Note:

- Some Apps cannot be moved.

How are recommendations created?

Recommendations on the platform are dependent on the ability and willingness of partners to provide metadata to the platform. The content is positioned depending on the following criteria:

Above the fold applications:

The recommendations originate from the Content partners that are highlighted. They are in the domain of the end-user.

Below the fold applications:

Recommendation rows are created by the editorial team, following these guidelines:

1. Content variety – Providing a broad selection of content
2. Type of access variety – Providing advertising-supported, subscription, and transactional content
3. Balance – Providing a balance between global and local content