

TCX 200 - 300

UPUTSTVO ZA UPOTREBU

gorenje

INSTRUCTIONS FOR USE

SR/MNE

EN

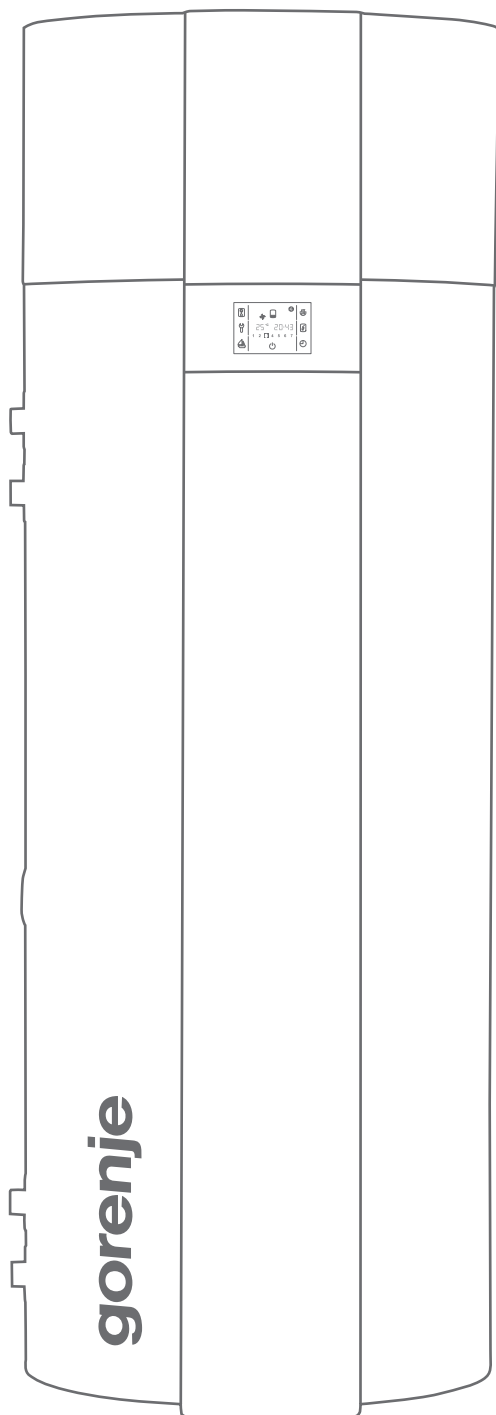

UPOZORENJA

-  Deca starija od 8 godina i osobe sa ograničenim fizičkim, osećajnim i mentalnim sposobnostima ili nedostatkom znanja mogu upotrebljavati uređaj samo pod nadzorom ili ako su obučeni za njegovo bezbedno korišćenje i razumevanje mogućih opasnosti prilikom njegovog korišćenja.
-  Deca se ne smeju igrati sa uređajem.
-  Deca bez nadzora ne smeju čistiti i održavati uređaj.
-  Toplotnu pumpu prevozimo u uspravnom položaju, eventualno je možete postaviti pod uglom od 35° u svim smerovima. Pazite da u transportu ne oštetite kućište i vitalne delove uređaja.
-  Toplotna pumpa nije namenjena upotrebi u prostorima gde su prisutne korozivne i eksplozivne materije.
-  Priključivanje toplotne pumpe na električnu mrežu mora da bude izvedeno u skladu sa standardima za električne instalacije. Između toplotne pumpe i trajnih instalacija mora biti ugrađena priprema za odvajanje svih polova od električne mreže u skladu sa nacionalnim instalacionim propisima.
-  Da se ne bi oštetio agregat, toplotna pumpa ne sme raditi bez vode u bojleru!
-  Instalaciju toplotne pumpe mora izvesti stručno osposobljen montažer u skladu sa važećim propisima po uputstvima proizvođača.
-  Kod priklučivanja zatvorenog sistema za regulisanje pritiska obavezno morate na dovodnu cev toplotne pumpe ugraditi sigurnosni ventil s nazivnim pritiskom 0,6 MPa (6 bar) koji sprečava porast pritiska za više od 0,1 MPa (1 bar) u odnosu na nazivni.
-  Otvor za oticanje mora biti otvoren na atmosferski pritisak zato što voda iz njega može kapljati.
-  Ispust sigurnosnog ventila mora biti podešen u smeru nadole i u sredini gde ne zamrzava.
-  Da bi osigurali pravilan rad sigurnosnog ventila morate sami izvoditi redovnu kontrolu, po potrebi uklanjati kamenac i proveriti da sigurnosni ventil nije blokiran.
-  Između toplotne pumpe i sigurnosnog ventila se ne sme ugraditi ventil za zatvaranje koji bi onemogućio delovanje sigurnosnog ventila!
-  Elementi u električnoj pogonskoj jedinici su pod naponom čak i kada se isključe pritiskom na polje za isključivanje (9) toplotne pumpe.
-  U slučaju otkazivanja radnog termostata je zaštićena toplotna pumpa dodatnim toplotnim osiguračem. U skladu sa sigurnosnim standardima voda u toplotnoj pumpi može tada postići temperaturu i do 130°C. Pri izvođenju vodovodnih instalacija se mora poštovati mogućnost da može doći do navdenog temperaturnog opterećenja.
-  Ako toplotnu pumpu isključujete iz mreže, morate pustiti da voda iz nje isteče, da ne bi došlo do zamrzavanja.
-  Voda iz toplotne pumpe se prazni kroz dovodnu cev kotla. Zato se preporučuje da između sigurnosnog ventila i dovodne cevi namestimo poseban član ili ispusni ventil.
-  Molimo vas da u slučaju eventualnog kvara ne popravljate uređaj sami nego da pozovete ovlašćenu servisnu službu.
-  Nije dozvoljeno priklučivanje toplotne pumpe u zajednički cevovod sa kuhinjskim aspiratorom i odvod vazduha iz više manjih stanova ili apartmana.
-  Pri padu temperature dodatnog izvora grejanja i pri omogućenoj cirkulaciji vode kroz prenosnik toplote može doći do nekontrolisanog odvoda toplote iz bojlera. Pri priklučivanju na druge izvore grejanja je potrebno voditi računa o pravilnom izvođenju temperaturne regulacije dodatnog izvora.
-  Agregat toplotne pumpe mora biti isključen kada je pumpa prikjučena na prijemnik sunčeve energije kao spoljašnjeg izvora toplote. Kombinacija oba izvora dovodi do pregrejavanja sanitarne vode i samim tim do povišenog pritiska.
-  Cirkulacioni vod dovodi do dodatnih toplotnih gubitaka u bojleru.
-  Verzija bez grejača (modeli Z) bojlera za toplu vodu sa toplotnom pumpom nema zaštitu od zamrzavanja!
-  Ovaj proizvod sadrži fluorisane gasove koji izazivaju efekat staklene bašte. Hermetički zaptiveno.

 Naši proizvodi su napravljeni od komponenti koje nisu štetne za sredinu i zdravlje i koje su izrađene tako da ih u njihovoj završnoj životnoj fazi možemo što bolje i jednostavnije rastaviti i reciklirati.

Reciklažom materijala smanjujemo količinu otpadaka i smanjujemo potrebu za proizvodnjom osnovnih materijala (na primer metala), koja zahteva ogromno energije i rezuljuje ispuštima štetnih materija. Postupcima reciklaže smanjujemo potrošnju prirodnih resursa tako da otpadne delove iz plastike i metala ponovo vraćamo u različite proizvodne procese.

Više informacija o sistemu odlaganja otpadaka možete dobiti na svom centru za odlaganje otpadaka ili od prodavca vašeg proizvoda.

Poštovani kupče, zahvalni smo vam što ste se odlučili za naš proizvod. MOLIMO VAS DA PRE UGRAĐIVANJA I PRVE UPOTREBE BOJLERA S TOPLOTNOM PUMPOM PAŽLJIVO PROČITATE UPUTSTVA.

Bojler s toplotnom pumpom je izrađen u skladu sa važećim standardima koji proizvođaču dozvoljavaju upotrebu CE znaka. Njegove osnovne tehničke specifikacije su navedene na napisnoj tablici koja je nalepljena na pozadinskoj gornjoj strani bojlera.

Bojler s toplotnom pumpom sme priključiti samo za to osposobljen stručnjak. **Intervencije u njegovu unutrašnjost zbog popravke, uklanjanje kamenca može vršiti samo ovlašćena servisna služba.** Posebno pažljivo poštujujte uputstva za postupanje prilikom eventualnih kvarova i uputstva za sigurnu upotrebu toplotne pumpe.

Tu knjižicu sačuvajte da bi je mogli pogledati kada ste u nedoumici u vezi sa radom ili održavanjem uređaja. Uputstva za instalaciju i upotrebu su na raspolaganju i na našoj intenetnoj strani <http://www.gorenje.com> ili na nacionalnim stranama u rubrikama servis odnosno podrška. Uvek su vam na raspolaganju ovlašćeni serviseri koje možete pozvati za povremeno održavanje uređaja.

Bojler s toplotnom pumpom je izrađen tako da se mogu upotrebljavati i drugi izvori grejanja:

- kotao centralnog grejanja
- sunčeva energija
- električni grejač.

PODRUČJE UPOTREBE

Toplotne pumpe ove vrste su namenjene pre svega zagrevanju potrošne vode u gospodinjstvu ali i drugim korisnicima kod kojih dnevna potrošnja tople vode (50 °C) ne prelazi 400 do 700 l. **Podešavanje temperature na aparatu treba da bude takvo da zadovoljava stvarnim potrebama, preporučujemo da je to između 45 in 55°C. Ako su temperature više smanjuje se efikasnost (COP) i produžava vreme grejanja odnosno broj radnih sati, te ih zato ne preporučujemo.** Pošto toplotna pumpa svojim radom hladi prostor je efektivnost upotrebe toplotne pumpe dvojna (grejanje vode – hlađenje prostora). Rad toplotne pumpe je potpuno automatizovan.

Uređaj se mora priključiti na kućne instalacije sanitarne tople vode i za rad mu je potrebna električna energija. Uduvavanje i izduvavanje vazduha se može izvesti i uduvavanjem i izduvavanjem vazduha iz drugog prostora. Zbog lakše kontrole, preporučujemo da iznad uređaja ostavite dovoljno prostora (Slika 2). Drugačija upotreba uređaja od navedene u uputstvu nije dozvoljena. Aparat nije namenjen upotrebi u prostorijama gde su prisutne korozivne i eksplozivne materije. Proizvođač ne odgovara za oštećenja koja su nastala zbog nepravilne ugradnje i upotrebe koje nisu u skladu sa uputstvima za upotrebu i montažu.

Uputstva za upotrebu su sastavni i važan deo proizvoda i moraju da budu izručena kupcu. Pažljivo pročitajte upozorenja u uputstvu jer ćete samo tako izvesti bezbednu instalaciju i bezbedno upotrebljavati i održavati uređaj. Uputstva sačuvajte za kasniju upotrebu.

Oznaka vaše toplotne pumpe je navedena na nazivni pločici koja se nalazi na gornjoj strani aparata.

Kada uklonite ambalažu pregledajte sadržaj paketa. Ako imate bilo kakve nedoumice se obratite dobavljaču. Delove ambalaže (pričvršćivače, plastične kese, ekspandiran polistirol itd.) ne puštajte blizu dece jer predstavljaju potencijalnu opasnost za njih. Ambalažu ne smete nemarno odložiti u životnu sredinu.

- ⚠ **Toplotna pumpa nije namenjena upotrebi u prostoriji gde su prisutne korozivne i eksplozivne materije.**
- ⚠ **Toplotnu pumpu prevozimo u uspravnom položaju, eventualno je možete postaviti pod uglom od 35° u svim smerovima. Pazite da u transportu ne oštetite kućište i vitalne delove uređaja.**

SKLADIŠTENJE I TRANSPORT

Morate osigurati skladištenje toplotne pumpe u suvoj i čistoj prostoriji i u uspravnom položaju.

TEHNIČKE SPECIFIKACIJE UREĐAJA

TIP KLJUČA

TCX 306 Z XY

Y = Niskotemperaturni rad **NT** - nema oznake, nema ga

X = Ugrađen grejač **G** - nema oznake, nema ga

Toplotna pumpa s integrisanim agregatom i jednim izmenjivačem

Tipovi		TCX 200 Z XY	TCX 201 Z XY	TCX 300 Z XY	TCX 306 Z XY
Područje upotrebe		L	L	XL	XL
Razred energetske efikasnosti ¹⁾		A+	A+	A+	A+
Energetska efikasnost zagrevanja vode η_{wh} ¹⁾	%	128,5	127,0	136,0	134,4
Godišnja potrošnja električne energije ¹⁾	kWh	797	806	1231	1246
Dnevna potrošnja električne energije ¹⁾	kWh	3,762	3,813	5,707	5,787
Podešena temperatura termostata	°C	55	55	55	55
Nivo zvučne jačine u unutrašnjim prostorijama ³⁾	dB (A)	59/58	59/58	59/58	59/58
Vrednost smart		0	0	0	0
Zapremina	l	208,0	194,0	295,0	276,0
Mešana voda pri 40°C V40 ²⁾	l	260	248	395	368
Eventualne sigurnosne mene (sastav, nameštanje, održavanje)		Kod priključivanja pod pritiskom je obavezna upotreba sigurnosnog ventila.			
Tehničke osobine					
Vreme zagrevanja A15 / W10-55 ⁴⁾	h:min	05:21	05:13	08:32	08:00
Vreme zagrevanja A7 / W10-55 ⁵⁾	h:min	06:24	06:06	09:40	09:39
Potrošnja energije u izbranom ciklusu ispusta A15 / W10-55 ⁴⁾	kWh	3,71	3,86	5,75	5,75
Potrošnja energije u izbranom ciklusu ispusta A7 / W10-55 ⁵⁾	kWh	3,82	3,97	5,80	5,96
COP _{DHW} A15/W10-55 ⁴⁾		3,25	3,12	3,42	3,38
COP _{DHW} A7/W10-55 ⁵⁾		3,10	3,06	3,34	3,30
Snaga u stanju pripremljenosti ⁵⁾	W	24	26	18	20
Sredstvo za hlađenje		R134a	R134a	R134a	R134a
Količina sredstva za hlađenje	kg	1,100	1,100	1,100	1,100
Potencijal globalnog zagrevanja		1430	1430	1430	1430
Ekvivalent ugljen-dioksida	t	1,573	1,573	1,573	1,573
Područje rada standardnog modela	°C	7 ÷ 35	7 ÷ 35	7 ÷ 35	7 ÷ 35
Područje rada NT ⁶⁾	°C	-7 ÷ 35	-7 ÷ 35	-7 ÷ 35	-7 ÷ 35
Područje protoka vazduha	m ³ /h	220-450	220-450	220-450	220-450
Pad pritiska kod 330 m ³ /h (60%)	Pa	100	100	100	100
Električne karakteristike					
Nazivna električna snaga kompresora	W	490	490	490	490
Moć grejača X ⁷⁾	W	2000	2000	2000	2000
Maksimalna priključna snaga bez grejača/sa grejačima	W	490/2490	490/2490	490/2490	490/2490
Napon	V/Hz	230/50	230/50	230/50	230/50
Električno osiguranje	A	16	16	16	16
Nivo zaštite od vlage		IP24	IP24	IP24	IP24
Bojler					
Antikorozivna zaštita kotla		Nerđajući čelik			
Nazivni pritisak	MPa	0,6/0,9/1,0	0,6/0,9/1,0	0,6/0,9/1,0	0,6/0,9/1,0
Najviša temperatura vode toplotne pumpe	°C	65	65	65	65
Najviša temperatura vode električnog grejača ⁷⁾	°C	75	75	75	75
Mere priključivanja					
Ukupna visina	mm	1540	1540	1960	1960
Širina	mm	670	670	670	670
Dubina	mm	690	690	690	690
Priključki na vodovodnu mrežu		G1	G1	G1	G1
Dimenzije vazdušnih priključaka	mm	Ø160	Ø160	Ø160	Ø160
Zagrevana površina PT - donji	m ²	/	1,45	/	1,6
Priključki izmenjivača		-	G1	-	G1
Neto/Bruto/Masa s vodom	kg	104/116/312	133/145/327	123/135/418	177/189/453
Temperatura grejnog medija u PT	°C	/	5 ÷ 85	/	5 ÷ 85
Transportni podaci					
Mere ambalaže	mm	800x800x1765	800x800x1765	800x800x2155	800x800x2155

¹⁾ direktiva 812/2013, 814/2013, EN16147:2011. Prosečni klimatski uslovi

²⁾ po EN16147:2011

³⁾ po EN12102:2013 (60% brzina ventilatora-kanalni sistem / 40% brzine ventilatora - zapreminski vazduh)

⁴⁾ ulazna temperatura vazduha 15°C, 74% vlažnost, voda zagrevana od 10 do 55 °C po EN16147:2011

⁵⁾ ulazna temperatura vazduha 7°C, 89% vlažnost, voda zagrevana od 10 do 55 °C po EN16147:2011

⁶⁾ niskotemperaturno izvođenje oznaka NT, ako je nema radi se o standardnom modelu

⁷⁾ model sa grejačem očito na tipskoj oznaci - slovo G, ako je nema radi se o modelu bez grejača

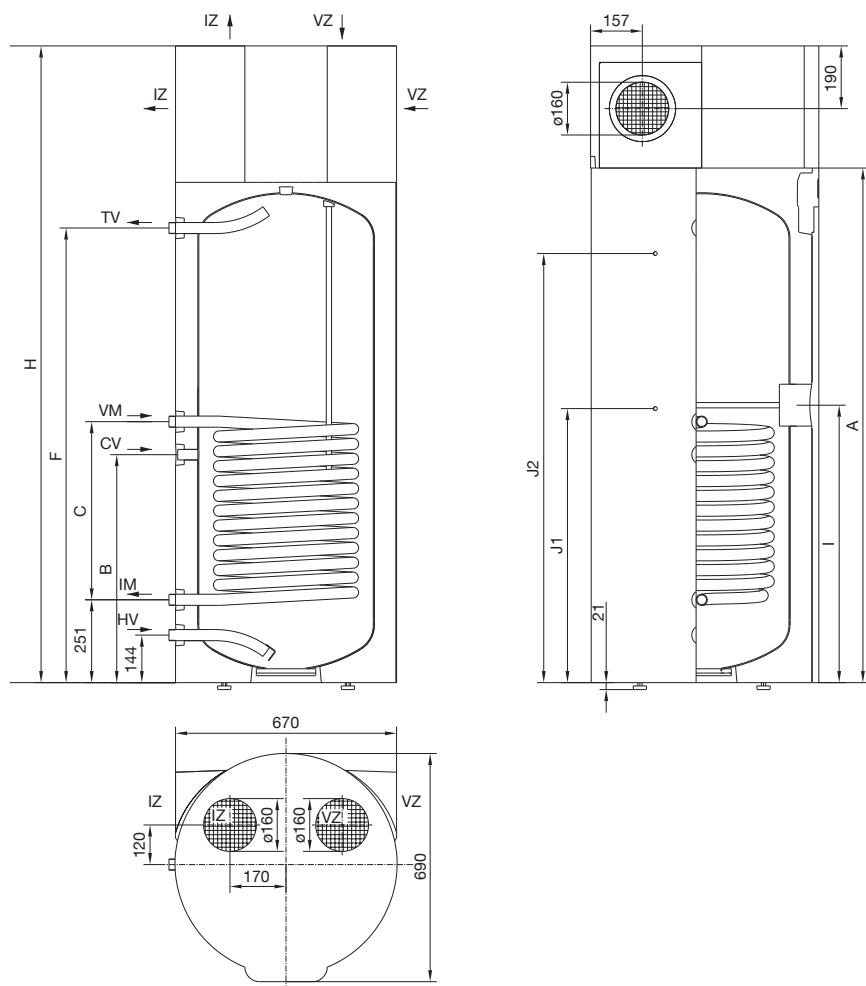
**LEGENDA**

PT	Prenosnik toplote
HV	Dotok hladne vode (plava rozeta)
IM	Izlaz medijuma PT (crna rozeta)
CV	Cirkulacioni vod (crna rozeta)
VM	Ulaz medijuma PT (crna rozeta)
TV	Otok tople vode (crvena rozeta)
J1	Cev za senzore
J2	Cev za senzore
VZ	Ulaz vazduha
IZ	Izlaz vazduha

	TCX 200 Z XY	TCX 201 Z XY	TCX 300 Z XY	TCX 306 Z XY
A (mm)	1170	1170	1560	1560
B (mm)	580	580	690	690
C (mm)	/	620	/	540
F (mm)	975	975	1375	1375
H (mm)	1540	1540	1930	1930
I (mm)	615	615	840	840
J1 (mm)	/	/	/	790
J2 (mm)	/	900	/	1300
HV	G1	G1	G1	G1
IM	/	G1	/	G1
CV	G3/4	G3/4	G3/4	G3/4
VM	/	G1	/	G1
TV	G1	G1	G1	G1

Sl. 1: Priključne i montažne mere bojlera [mm]

INSTALIRANJE SENZORA SPOLJAŠNJEG IZVORA GREJANJA

Na levoj strani bojlera su otvori (J1, J2) u koje se mogu staviti senzori za regulaciju sistemske povezanosti bojlera sa drugim izvorima grejanja. Maksimalni prečnik senzora je 8 mm. Dužina cevi za senzor iznosi 180 mm.

Senzor namestite u cev i pričvrstite ga:

- ako senzor budete namestili više od preporučenog položaja, termostat će brže reagovati, intervali rada toplotne pumpe biće kraći, razlika između temperature vode u rezervoaru i ogrevanim medijima posle isključivanja termostata biće viša, a kao posledica količina i temperatura tople vode u rezervoaru biće niža,
- ako senzor budete namestili niže od preporučenog položaja, intervali rada pumpe biće duži, razlika između temperature zagrevanog medijuma i ostvarene temperature vode u rezervoaru niža, a temperatura i količina vode u grejaču biće zbog toga viša.

INSTALACIJA BOJLERA SA TOPLOTNOM PUMPOM

Bojler s toplotnom pumpom se može upotrebljavati sa prostorskim ili upravljanim vazduhom.

Da bi sprečili pojavu podpritiska u zgradama, morate kontrolisano dovoditi svež vazduh u prostoriju. Željeni nivo promene vazduha za stambenu zgradu iznosi 0,5 što znači da se celokupna količina vazduha u zgradi promeni na svakih 2h.

RAD SA PROSTORSKIM VAZDUHOM (odgovara modelima ZG i Z)

Kod rada sa prostorskim vazduhom se za zagrevanje sanitarne vode upotrebljava samo količina energije vazduha iz prostora u kome je postavljen uređaj. Bojler sa toplotnom pumpom se može namestiti u suhu prostoriju u kojoj ne smrzava po mogućnosti u blizini drugih izvora grejanja s temperaturom od 7 do 35°C i minimalne veličine 20m³. Kao optimalnu sredinu za rad pumpe preporučujemo dovoljno veliki i provetren prostor sa temperaturom od 15 do 20°C. Kod izbora prostora za postavljanje bojlera sa toplotnom pumpom takođe moramo posebno paziti da nije prašnjav, zato što prašina štetno utiče na efikasnost toplotne pumpe. Kod rada s prostorskim vazduhom ne moramo brinuti o padanju pritiska i zato se preporučuje da brzinu ventilatora smanjimo iz fabrički nameštene 60% na 40% (gledaj kasnija poglavlja).

Kod bojlera sa toplotnom pumpom je na raspolaganju više načina upotrebe usisnog i ispusnog otvora. (gledaj slike).

Za prostorski vazduh je najprimerenija upotreba bočnih priključaka za usisavanje i izduvavanje jer će tako doći do najmanjeg mešanja vazduha.

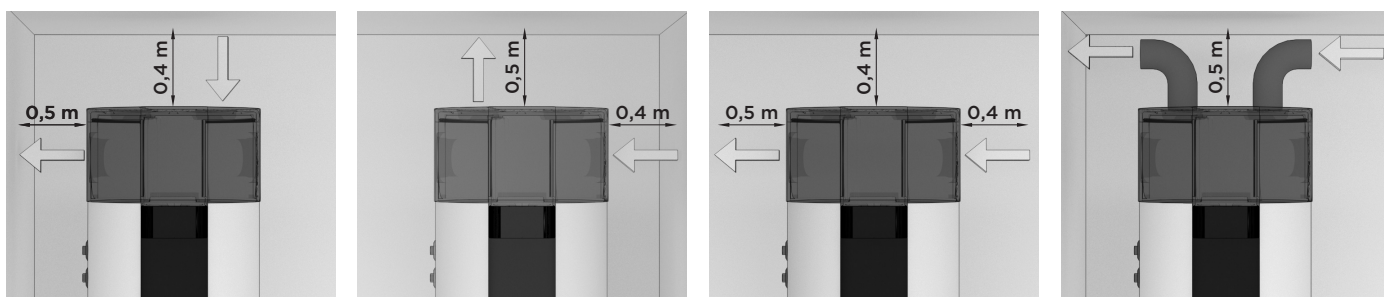

Sl. 2: Načini upotrebe usisnog i ispusnog otvora

RAD SA UPRAVLJANIM VAZDUHOM (odgovara modelima ZGNT)

Kod rada sa upravljanim vazduhom, toplotna pumpa preko cevovodnog sistema dovodi tj. odvodi vazduh i iz drugih prostorija. Preporučljivo je da se sistem cevovoda termički izoluje, da se u unutrašnjosti cevi ne bi stvarao kondenz. Kod uduvavanja vazduha iz spoljašnjosti, spoljašnji deo se mora prekriti rešetkom da se spreči prodor većih delova prašine i snega u uređaj.

Da bi rad toplotne pumpe uvek bio efikasan, ugradnjom upravljačkih vrata možete da zahvatate vazduh iz prostorije ili spoljašnjosti a zatim ga vraćate u prostorije ili na otvoreno. Temperatura zahvaćenog vazduha mora odgovarati specifikaciji proizvoda (gledaj tabelu tehničkih specifikacija).

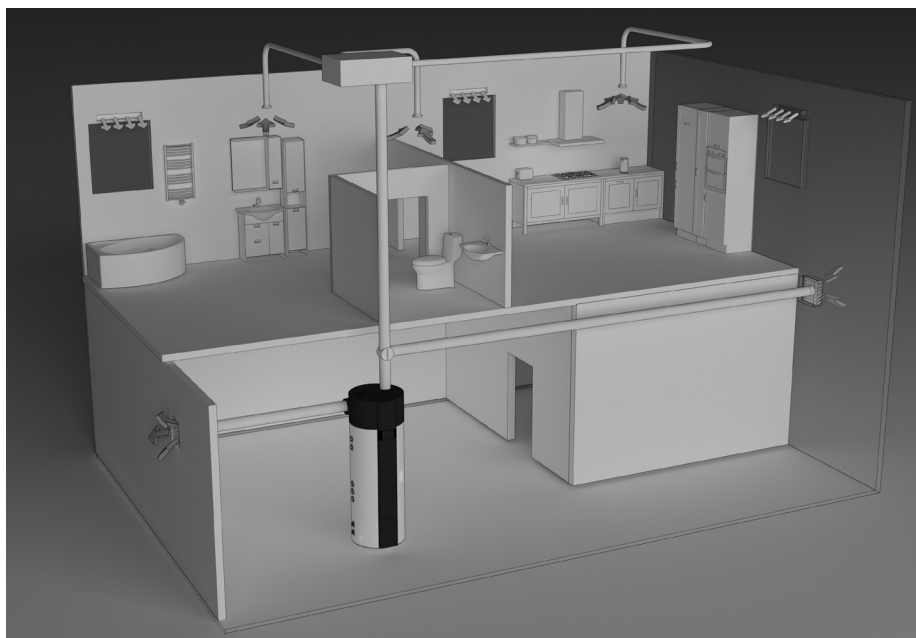

Sl. 3: Rad sa upravljanim vazduhom

ODREĐIVANJE PADA PRITISKA KOD CEVOVODNOG SISTEMA DOVODA I ODVODA VAZDUHA

Toplotna pumpa omogućava različita podešavanja cevni priključaka usisnog i ispusnog zraka. Preporučuje se upotreba priključaka koji omogućavaju najjednostavnije priključenje aparata na kanalni sistem. Kod samog planiranja cevovodnog sistema za dovod i odvod vazduha iz i u toplotnu pumpu je od ključne važnosti da se poštuje aerodinamička karakteristika ventilatora iz koje proizlazi raspoloživi gubitak statičkog pritiska. Aerodinamička karakteristika ventilatora je prikazana na grafikonu i predstavljena kao pad pritiska u zavisnosti od protoka vazduha. Radna tačka ventilatora toplotne pumpe se nalazi na 100Pa statičkog pritiska odnosno kad je protok vazduha 330 m³/h. Kao prihvatljiv radni pad statičkog pritiska u vazдушnom cevovodu se za naše toplotne pumpe smatra $\Delta p = 100$ Pa. Kada izračun pokaže veći pad pritiska se brzina ventilatora poveća. Povećavanje brzine je efikasno do 80%, nakon toga se protok više ne povećava i zato povećavanje brzine iznad te vrednosti nesavetujemo zbog buke.

Diagram prikazuje sledeća područja:

- Visoko-efikasno područje rada – područje visokih vazдушnih protoka (nad 300m³/h) zahteva manje padove pritiska (montaža bez kanala ili sa kratkim kanalima) i podešavanje ventilatora 60 ali 80%.
- Radno područje rada – područje srednjeg vazдушnog protoka (između 200 i 300m³/h) koje predstavlja 40% podešavanje ventilatora i minimalni pad pritiska ili 60% ili 80% podešavanje ventilatora i pad pritiska između 50 i 300pa.
- Rašireno područje rada, predstavlja veće mogućnosti podešavanja i visokih padova pritiska. **Sme se koristiti samo ako je temperatura vazduha iznad 20°C.** Ako taj uslov nije ispunjen će efikasnost početi da pada.

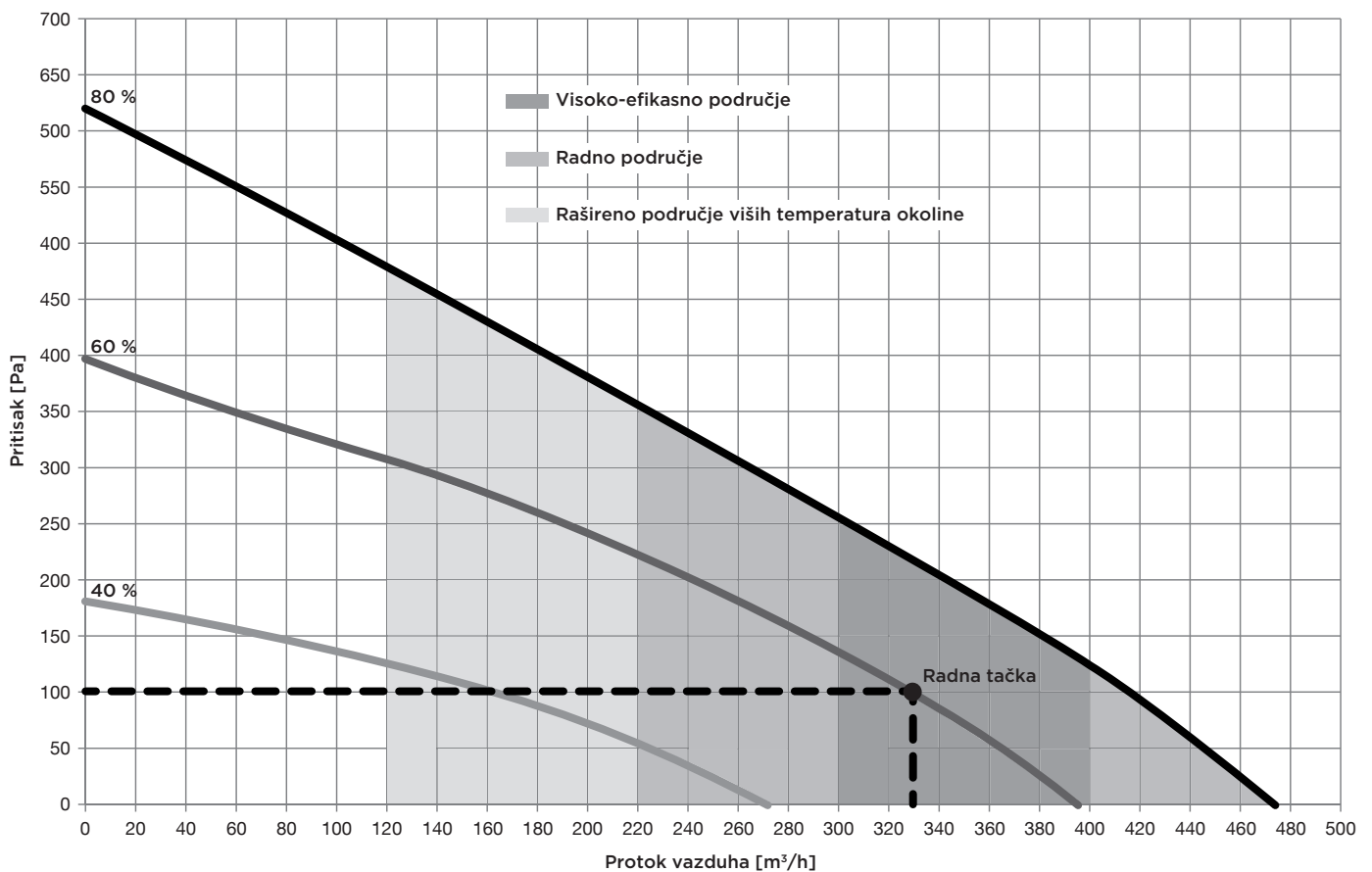

SI. 4: Aerodinamička karakteristika ventilatora pumpe

Vrednost skupnog pada statičkog pritiska se izračuna sabiranjem gubitaka pojedinačnih elemenata ugrađenih u vazдушnom cevovodnom sistemu. Vrednosti padova statičkog pritiska pojedinačnih elemenata (padovi statičkog pritiska pojedinačnih elemenata se odnose na unutrašnji prečnik 150 mm) i prikazane su u tabeli.

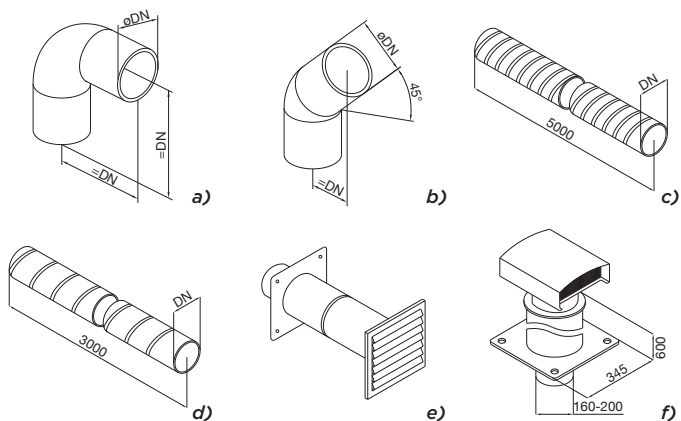

Vrste elemenata i pripadajućih vrednosti padova pritiska

Vrsta elementa	Vrednost pada statičkog pritiska
a) Luk 90°	5 Pa
b) Luk 45°	3 Pa
c) Fleksibilna cev	5 Pa/m
d) Spiralna cev	3 Pa/m
e) Usisna rešetka	25 Pa
f) Krovni provodnik za otpadni vazduh	10 Pa

Sl. 5: Shematski prikaz osnovnih elemenata u cevovodnom sistemu za dovod tj. odvod vazduha

Izračuni vrednosti padova pritiska su informativne. Za preciznije izračune protoka je potrebno pridobiti detaljne karakteristike upotrebljenih elemenata odnosno obratiti se projektantu. Po instalaciji se preporučuje da napravite merenje protoka u cevnom sistemu. Primer celokupnog gubitka statičkog pritiska se izračuna sabiranjem gubitaka statičkog pritiska pojedinačnih elemenata ugrađenih u cevovodni sistem. Preporučljivo nominalni rad je pri ukupnom padu cca. 100 Pa. U slučaju nižeg protoka počne COP padati.

Primer izračuna

	Broj elemenata	Δp (Pa)	$\Sigma \Delta p$ (Pa)
Luk 90°	4	5	20
Fleksibilna cev	9	5 Pa/m	45
Usisna rešetka	1	25	25
Krovni provodnik za otpadni vazduh	1	10	10
Ukupno			100

⚠ Priključivanje toplotne pumpe u zajednički cevovod s kuhinjskim aspiratorom i odvođenje vazduha iz više manjih stanova ili apartmana nije dozvoljeno.

Svojim radom toplotna pumpa u unutrašnjosti agregata stvara kondenz koji treba odvoditi u kanalizaciju preko pokretne odvodne cevi $\varnothing 16\text{mm}$ za kondenz na poledini toplotne pumpe. Količina kondenza zavisi od temperature in vlažnosti vazduha.

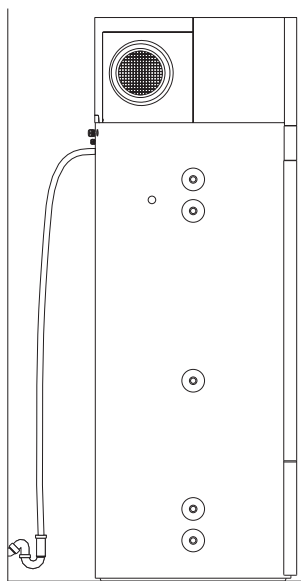

Sl. 6: Priključivanje na vodovod - odvod kondenza

Da bi smanjili prenos buke i vibracija ugrađenog ventilatora i da se zvuk rada uređaja i njegove vibracije ne prenose kroz zidove u prostorije gde bi vam to smetalo (za spavanje i odmor) poštujujte sledeće savete:

- ugradite fleksibilne cevi za povezivanje za hidrauličke uređaje
- ugradite fleksibilnu cev za cevovod odvodnog/dovodnog vazduha
- predvidite izolaciju vibracija za zidne prenosioce
- predvidite prigušivače zvuka odvodnog/dovodnog vazduha
- cevovode za odvodni/dovodni vazduh pričvrstite sa prigušivačem vibracija
- predvidite izolaciju vibracija prema podu
- upotrebite nogice za postavljanje.

PRIKLJUČENJE NA VODOVOD

Priključenje na vodovod napravite po oznakama za priključke iz prethodnog poglavlja.

Na dovodnu cev zbog sigurnosti obavezno treba ugraditi sigurnosni ventil koji sprečava rast pritiska u kotlu za više od 0,1 MPa (1 bar) iznad nominalnog. Otvor za isticanje na sigurnosnom ventilu mora obavezno imati izlaz na atmosferski pritisak. Da bi sigurnosni ventil pravilno funkcionisao ga morate sami povremeno proveravati, po potrebi uklanjati kamenac, te proveravati da sigurnosni ventil nije blokiran. Kod proveravanja morate otvoriti otvor za isticanje iz sigurnosnog ventila sa okretanjem ručke ili odvijanjem matice ventila, prilikom čega voda mora da iscuri kao dokaz da je ventil ispravan. Kod zagrevanja vode u bojleru se pritisak vode u kotlu povećava do granice koja je podešena u sigurnosnom ventilu. Pošto je vraćanje vode u vodovod sprečeno može da dođe do kapljanja vode iz otoka otvora sigurnosnog ventila. Kapljajuću vodu možemo izvesti u odvod preko lovilnog produžetka koji se namesti ispod sigurnosnog ventila. Odvodna cev je nameštena ispod ispusta sigurnosnog ventila i mora biti usmerena ravno nadole i u sredini gde ne smrzava.

U slučaju da zbog neodgovarajuće izvedenih instalacija nemate mogućnost da kapljajuću vodu iz sigurnosnog ventila izvedete u odvod, možete ugraditi ekspanzionu posudu na dovodnoj cevi grejača. Zapremina ekspanzione posude je minimalno 5% zapremine bojlera.

Bojler možete priključiti na kućni vodovod bez redukcionog ventila ako je pritisak u vodovodni mreži niži od propisanog na tablici. U suprotnom je potrebno ugraditi redukcioni ventil koji će osigurati da pritisak u bojleru ne prevaziđe nazivni.

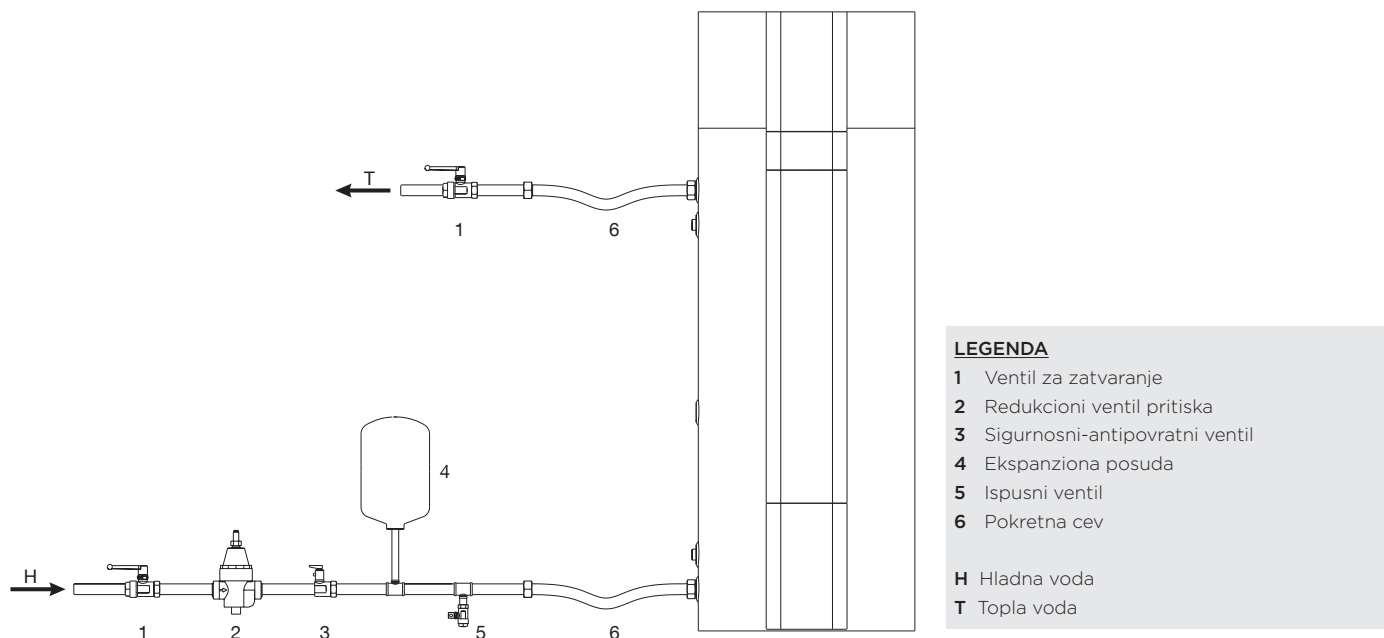

SI. 7: Zatvoreni sistem pritiska

! Toplotna pumpa ne sme raditi bez vode u bojleru zbog mogućeg oštećenja agregata.

PRIKLJUČENJE NA DRUGE IZVORE GREJANJA

Rezervoar za toplu vodu sa toplotnom pumpom omogućava pripremu tople sanitarne vode kroz izmenjivač toplote sa različitim izvorima energije (npr. centralno grejanje, solarna energija,...).

Mogućnosti povezivanja bojlera sa različitim izvorima grejanja su prikazane na skicama.

SR/MINE

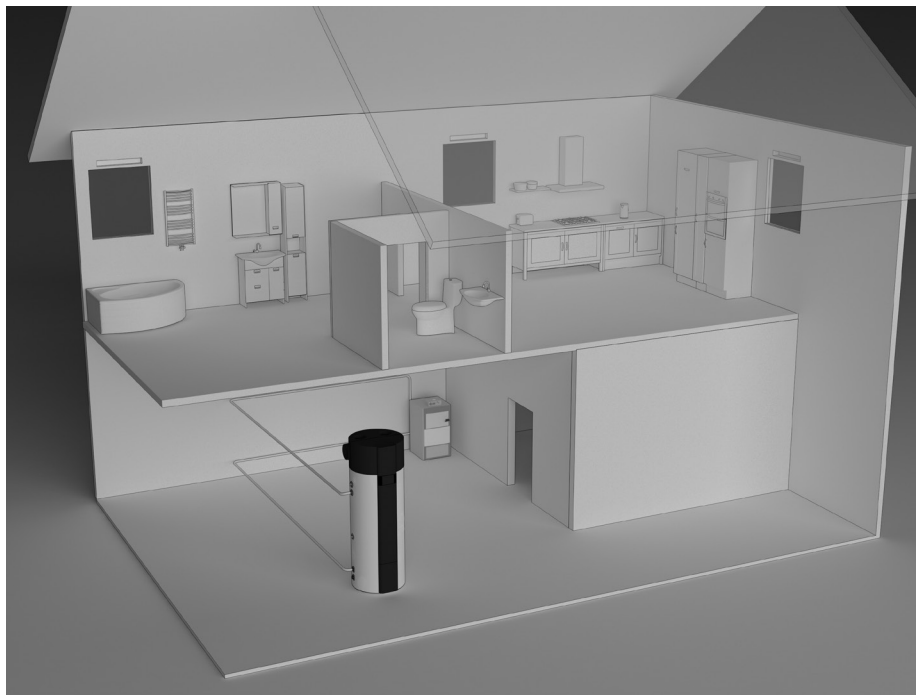

Sl. 8a: Priklučenje na centralno grejanje

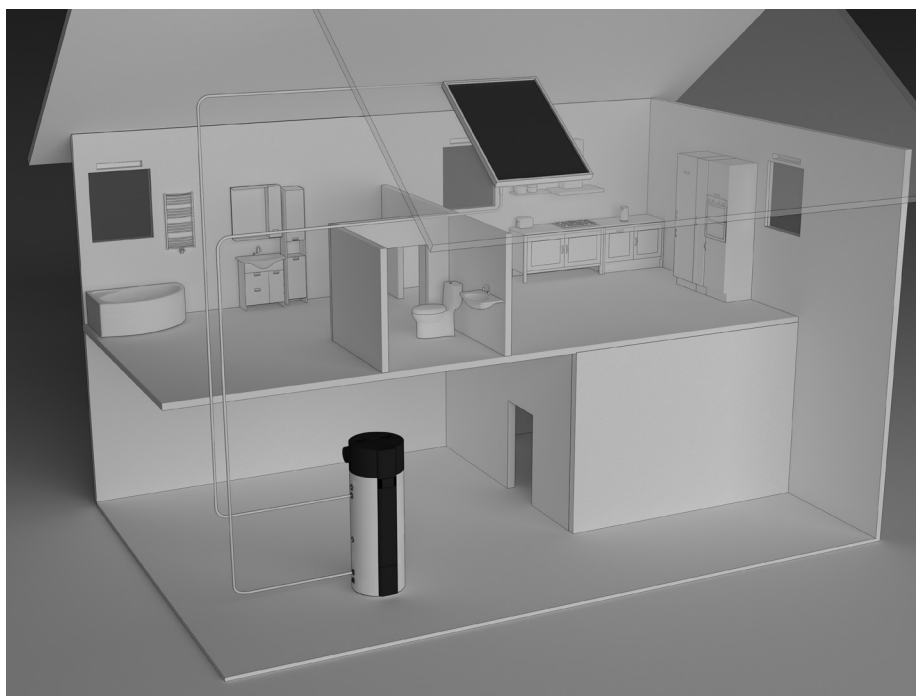

Sl. 8b: Priklučenje na solarni kolektor

- ⚠ Kod pada temperature dodatnog izvora grejanja, a kada je cirkulacija vode omogućena kroz prenosnik toplote, može doći do nekontrolisanog odliva toplote iz bojlera. Kod priključivanja na druge izvore je potrebno da se pobrinete za pravilno izvođenje temperaturne regulacije dodatnog izvora.
- ⚠ Agregat toplotne pumpe mora biti isključen kada je pumpa priključena na prijemnik sunčeve energije kao spoljašnjeg izvora toplote. Kombinacija oba izvora dovodi do pregrejavanja sanitarne vode i samim tim do povišenog pritiska.
- ⚠ Cirkularni vod dovodi do dodatnih toplotnih gubitaka u bojleru.

PRIKLJUČENJE NA ELEKTRIČNU MREŽU

Za priključivanje bojlera s toplotnom pumpom treba osigurati utikač koji je odgovarajući za tokovno opterećenje 16A. Priključivanje toplotne pumpe na električnu mrežu se mora obaviti u skladu sa standardima za električne instalacije. Između toplotne pumpe i trajne instalacije mora biti ugrađena priprema za odvajanje svih polova od električne mreže u skladu s nacionalnim instalacionim propisima.

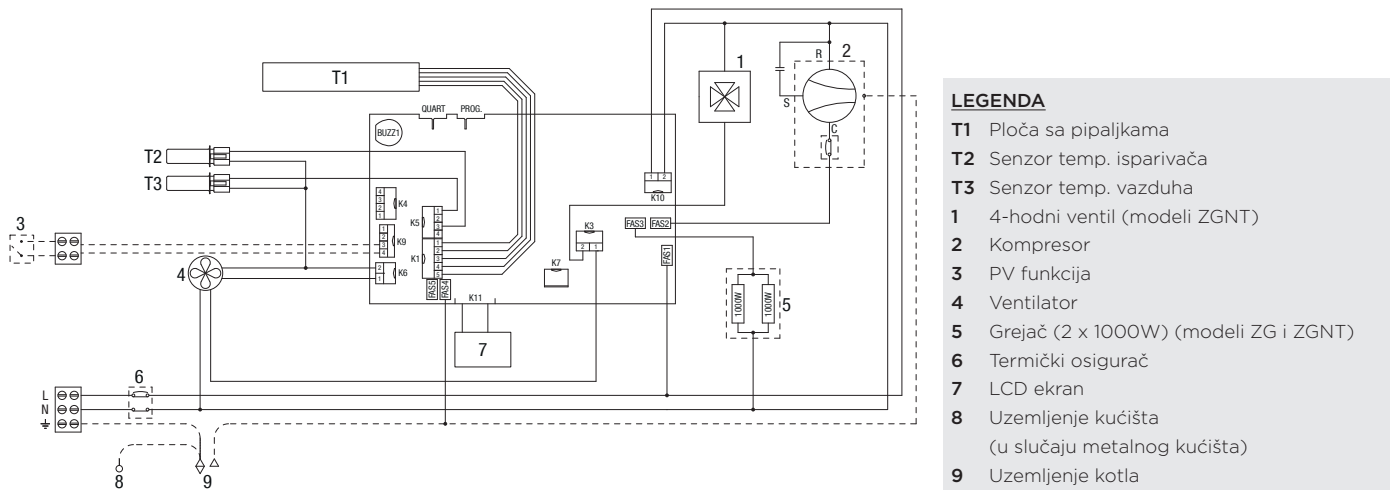

Sl. 9: Shema električne veze

UPRAVLJANJE TOPLOTNE PUMPE

Toplotnom pumpom upravljate preko LCD ekrana osetljivog na dodir (Slika 10). Pritiskom na ekran ga osvetlite. Kad je ekran osvetljen su polja za upravljanje aktivna.

Toplotna pumpa je spremna za rad kada se sa napunjenim kotlom priključi na vodovodnu i električnu mrežu. Toplotna pumpa zagreva vodu u rasponima od 10 °C - 65 °C. Od 65 °C - 75 °C vodu zagreva električni grejač (modeli ZG i ZGNT).

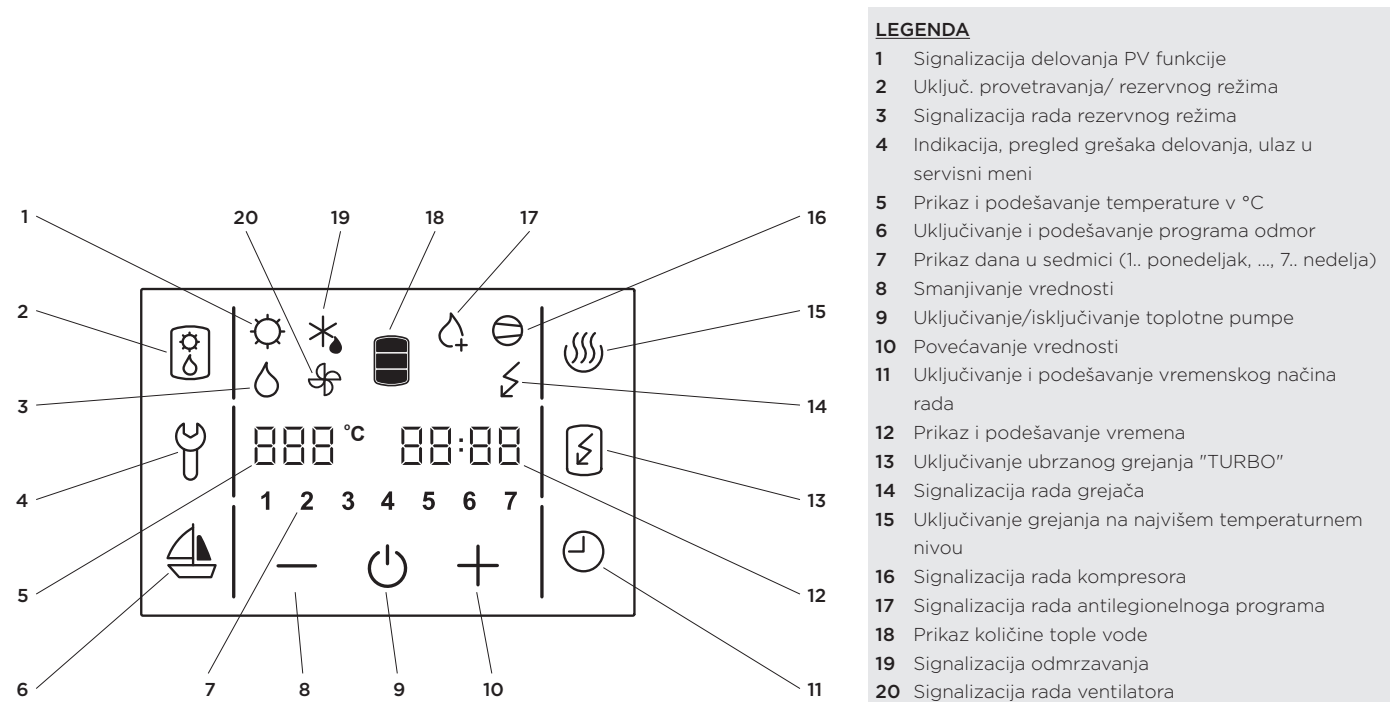

Sl. 10: Ekran za upravljanje

Uključivanje/Isključivanje toplotne pumpe

• Za uključivanje toplotne pumpe pritisnite polje 9.

Pri pokretanju uređaja se prvo uključi ventilator koji radi 1 minut (prikazan je simbol **20**). Ako je temperatura ulaznog vazduha odgovarajuća uključi se i kompresor tako da toplotna pumpa radi u normalnom režimu (prikazani u simbolima **16** i **20**). Toplotna pumpa je uključena, ekran neosvetljen.

Posle 60s od zadnjeg pritiska na ekran se njegovo osvetljenje ugasi što ne utiče na rad toplotne pumpe. Prvim pritiskom na ekran se on ponovo aktivira.

Ako uključujete uređaj na nižim temperaturama pogledajte poglavlje "Rad na nižim temperaturama".

• Dužim pritiskom na polje 9 se toplotna pumpa isključi.

Uređaj ne radi i na ekranu je vidljivo samo polje **9**. (Ako toplotnu pumpu za duže vreme isključujete, vodu morate ispustiti zbog mogućeg zamrzavanja).

Zaštita pri ispadu električne energije

U slučaju ispada električne energije podaci o podešavanjima ostanu sačuvani nekoliko sati.

Po ponovnom pokretanju napajanja, toplotna pumpa će nastaviti rad u istom režimu kao pre prekida napajanja.

Rad na nižim temperaturama

a) Nizkotemperaturni modeli sa grejačem (modeli ZGNT)

Pri pokretanju uređaja se prvo uključi ventilator (prikazan je simbol **20**). Ventilator se isključi ako je temperatura ulaznog vazduha niža od -7 °C. Za zagrevanje sanitarne vode se uključi grejač. Toplotna pumpa radi u rezervnom režimu (prikazan je simbol **14**). Możličnost prelaska na normalni režim rada se proverava periodično. Kada temperatura ulaznog vazduha postane viša od -7 °C, toplotna pumpa počne raditi u v normalnom režimu rada (prikazani su simbolima **16** i **20**). Grejač se isključi. Toplotna pumpa je uključena, ekran neosvetljen.

Kod nižih temperatura se po potrebi uključi režim odmrzavanja isparivača. Na ekranu se pokaže simbol **19**. Polja **2, 4, 6, 11, 13** i **15** su neaktivna. Odmrzavanje traje dok se ne postignu uslovi za normalan rad toplotne pumpe.

Posle uspešnog odmrzavanja se toplotna pumpa vrati u normalan rad. (prikazani su simbolima **16** i **20**).

Ako je odmrzavanje neuspešno pogon će javiti grešku. Polje **4** na ekranu počne treptati uz zvuk upozoravajućeg piska. U polju **12** se ispiše šifra greške **E247** i izvede se automatski prelaz na zagrevanje električnim grejačem. Na ekranu je prikazan simbol **14**. Šifru greške možete u svakom trenutku izbrisati pritiskom na polje **4**. U polju **12** će se ponovo prikazati vreme.

b) Modeli sa grejačem (modeli ZG)

Pri pokretanju uređaja se prvo uključi ventilator (prikazan je simbol **20**). Ventilator se isključi ako je temperatura ulaznog vazduha niža od 7 °C. Za zagrevanje sanitarne vode se uključi grejač. Toplotna pumpa radi u rezervnom režimu (prikazan je simbol **14**). Możličnost prelaska na normalni režim rada se proverava periodično. Kada temperatura ulaznog vazduha postane viša od 7 °C, toplotna pumpa počne raditi u v normalnom režimu rada (prikazani su simbolima **16** i **20**). Grejač se isključi. Toplotna pumpa je uključena, ekran neosvetljen.

c) Modeli bez grejača (modeli Z)

Određene funkcije (rezervni režim) opisane u tački **b** nisu moguće ako pumpa nema grejač. Takve pumpe ne mogu zagrejati sanitarnu vodu kada je temperatura vazduha izvan okvira njihovog rada. Możličnost prelaska na normalni režim rada se periodično proverava.

 **Kod modela bez grejača(modeli Z) bojler nema zaštitu od zamrzavanja!**

Podešavanja vremena i dana u sedmici

- Dužim pritiskom na polje **12** sačekajte da u polju **7** počne treptati broj dana u sedmici.
- Pritiskom na polje **+** ili **-** podesite broj dana u sedmici (1.. ponedeljak, ..., 7.. nedelja).
- Ponovo pritisnite na polje **12** (počne treptati sat).
- Pritiskom na polje **+** ili **-** podesite sat (dužim pritiskom na polje **+** ili **-** podešavanje ubrzate).
- Ponovo pritisnite na polje **12**.
- Počne treptanje za podešavanje minuta.
- Pritiskom na polje **+** ili **-** podesite minute (dužim pritiskom na polje **+** ili **-** podešavanje ubrzate).
- Podešavanje zapamtite ponovnim pritiskom na polje **12** odnosno kada polje **12** prestane treptati.

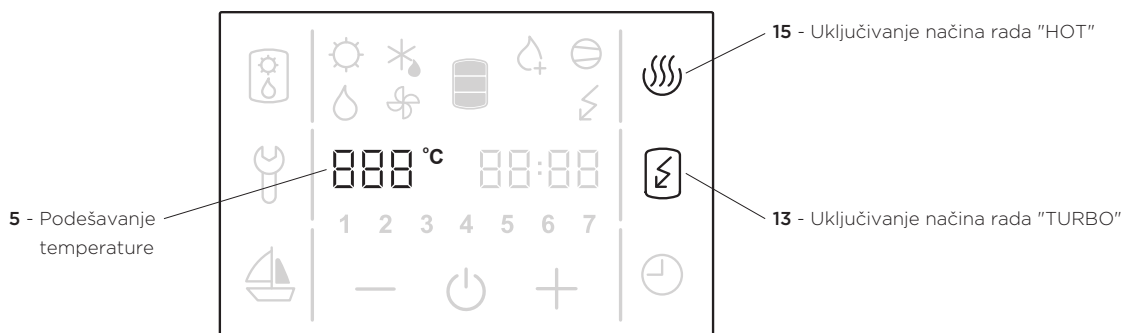

Sl. 11: Podešavanje temperature, uključivanje načina "TURBO" i "HOT"

Podešavanje temperature

- Pritisnite na polje **5** (treptće podešena temperatura).
- Pritiskom na polje **+** ili **-** menjate podešavanje temperature od 10 do 75 °C odnosno od 10 do 65°C (modeli Z). Fabrički je podešena ekonomična temperatura 55 °C.
- Podešavanje je zapamćeno ponovnim pritiskom na polje **5** kad polje **5** prestane treptati. Na ekranu se kroz nekoliko trenutaka pokaže stvarna temperatura. **Podešavanje na aparatu nek bude takvo da zadovoljava stvarne potrebe koje su između 45 in 55°C. Ne preporučujemo više temperature jer se time smanjuje efikasnost (COP) i produžava vreme grejanja i radnih sati.**
- Pri ispadanju napona u mreži se sačuva zadnja vrednost.

Uključivanje načina rada "TURBO" (modeli ZG i ZGNT)



- Ako u kratkom vremenskom periodu imate potrebu za većom količinom tople vode nego što je toplotna pumpa može zagrejati, pritisnite na ekranu polje **13** (uključite "TURBO" rad). U tom režimu istovremeno deluje toplotna pumpa i električni grejač. Na ekranu su prikazani simboli **14**, **16** i **20**. Kada temperatura dostigne 55 °C, pumpa se vrać u režim rada pre uključivanja „TURBO“ načina.
- Kod modela bez grejača se voda zagreje samo toplotnom pumpom i nema mogućnost bržeg zagrevanja vode.

Uključivanje načina rada „HOT“

- Da bi vodu zagrejali na maksimalnu temperaturu 75 °C, pritisnite na ekranu polje **15**. Toplotna pumpa će zagrejati vodu do 55 °C. Na ekranu su prikazani simboli **16** in **20**. Kada se voda u kotlu zagreje na 55 °C, uključi se električni grejač koji će zagrejati vodu do 75 °C. Na ekranu je prikazan simbol **14**. Kada temperatura dostigne 75 °C će se pumpa vratiti u način rada pre uključivanja "HOT" načina rada.
- Kod modela bez grejača (modeli Z) je funkcija neaktivna!

Prikaz količine tople vode u toplotnoj pumpi

Na polju **18** je prikazan simbol:

-  - nema tople vode
-  - manja količina tople vode
-  - veća količina tople vode

Podešavanje načina rada - odmor

U načinu rada odmor toplotna pumpa održava minimalnu temperaturu vode (približno 10°C) podešeni broj dana (maksimalno 100).

- Za duži vremenski period pritisnite polje **6** (polja 5 i 6 počnu treptati).
- Pritiskom na polje **+** ili **-** podesite broj dana odmora, prikazanih na polju **5**.
- Ponovnim pritiskom na polje **6**, odnosno kada polje **6** prestane treptati se podešeni broj dana sačuva.
- Ako podesite i potvrdite vrednost 000 će toplotna pumpa preći u normalni režim rada i polje **6** će se ugasisi.
- Posle podešenog broja dana će toplotna pumpa sama preći u normalan režim rada i polje **6** će se ugasisi.

Model bez grejača (modeli Z)

Kod modela bez grejača se minimalna temperatura održava radom toplotne pumpe. Kada je temperatura vazduha izvan okvira rada toplotne pumpe se voda neće zagrevati!

 **Kod modela bez grejača (modeli Z) bojler s toplotnom pumpom nema zaštitu od zamrzavanja!**

Podešavanje vremenskog načina rada

U vremenskom načinu rada podesite vreme uključivanja i isključivanja grejanja vode. Za svaku kombinaciju vremenskog ciklusa mogu se odrediti do tri vremenska perioda u kojima toplotna pumpa neće zagrevati vodu.

a) Podešavanje vremenskih ciklusa

- Duži pritisak na polje **11** (polja **7** i **11** trepću).
- Pritiskom na polje **+** ili **-** izaberete jednu od tri kombinacije vremenskog načina rada:
 - vremenski način rada toplotne pumpe za celu sedmicu (u polju 7 trepću brojevi 1 do 7),
 - vremenski način rada za period od ponedeljka do petka i od subote do nedelje (u polju 7 trepću brojevi od 1 do 5 i posle toga brojevi 6 i 7),
 - vremenski način rada za svaki pojedinačni dan (u polju 7 trepću pojedinačni brojevi 1 do 7).Za izbor željenog dana u sedmici pritisnite polja **+** ili **-**.
- Za podešavanje vremena pritisnite polje **12**.
- Na polju **5** se prikaže natpis 1OF, polje **12** trepće.
- Pritiskom na polje **+** ili **-** podesite vreme isključivanja toplotne pumpe.
- Ponovo pritisnite na polje **12**.
- Na polju **5** se prikaže natpis 1ON, polje **12** trepće.
- Pritiskom na polje **+** ili **-** podesite vreme uključivanja toplotne pumpe.
- Ponovnim pritiskom na polje **12** možete po gore opisanom postupku namestiti drugi i treći ciklus.
- U slučaju, da ne želite podesiti drugi i treći ciklus, potvrdite podešavanje pritiskom na polje **11** odnosno sačekajte da polje **12** prestane da trepće i da se podešavanje samostalno zapamti.
- Ako želite podesiti drugi i treći ciklus, podesite početak i kraj ciklusa 2 i 3 i podešavanje potvrdite gornjim postupkom, pritiskom na polje **11** ili sačekajte da polje **12** prestane da trepće i da se podešavanje samostalno zapamti.
- U slučaju podešavanja vremenskog načina rada »posebno za svaki dan u sedmici« odnosno » za period od ponedeljka do petka i od subote do nedelje«, potrebno je podesiti sva 3 časovna ciklusa po gore opisanom postupku.

b) Uključivanje/isključivanje časovnika

- Pritiskom na polje **11** uključite podešeni vremenski način rada.
- Toplotna pumpa zagreva vodu u ciklusima ON (u odnosu na nameštenu temperaturu). U ciklusima OFF se voda ne zagreva.
- Ponovnim pritiskom na polje **11** isključite podešeni vremenski način rada.

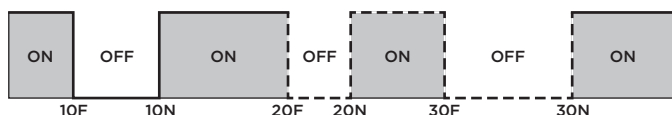

Sl. 12: Vremenski ciklusi

Određivanje podešavanja ventilatora

Pri određenom padu pritiska izaberemo režim u kome će raditi ventilator. Time odredimo brzinu rada ventilatora. Režim izaberemo pomoću **grafa (sl. 4)** koji prikazuje aerodinamičku karakteristiku ventilatora u zavisnosti od protoka vazduha i pada pritiska na cevovodu.

Buka

Povećavanjem aerodinamičke karakteristike od najniže do najviše se povećava i bučnost sistema. U području aerodinamičkih karakteristika od 80% i 100% je primećena veća bučnost.

Struktura servisnog nivoa

Na **sl. 13** je predstavljena struktura podele servisnih nivoa.

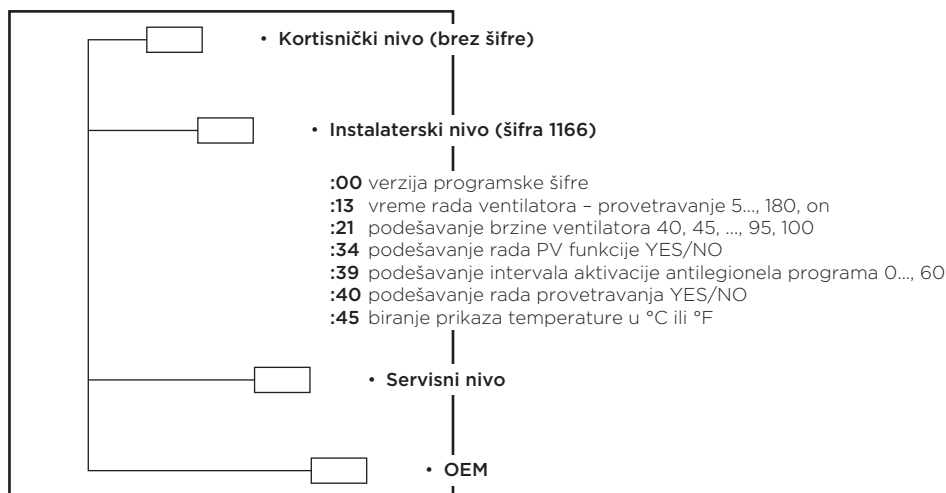

Sl. 13: Struktura podele servisnog nivoa

Dostup do servisnog nivoa

- Funkcija »servisni režim« se uključi dužim pritiskom na polje **4** na prikazivaču **sl. 10**.
- Pojavi se ulazni meni s natpisom šifre u polju **CLOCK**, za unos servisne šifre (polja FN1, FN2, FN3, FN4, FN5 in FN6) unosimo brojeve 1, 2, 3, 4, 5, 6.

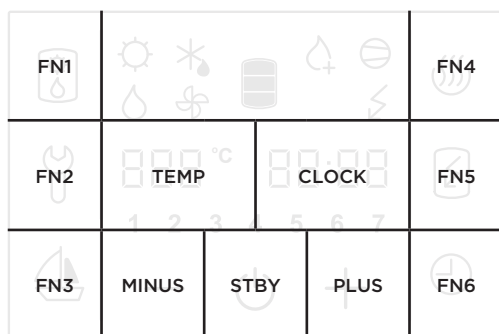

Sl. 14: Prikaz polja na prikazivaču

- Ako se u 10s intervalu ne pritisne nijedno polje će se uređaj automatski iz menija vratiti u prethodno stanje.
- Ako se šifra unese nepravilno će uređaj automatski izaći iz ulaznog menija.
- Kada šifru unesemo pravilno prikaže se prvi parametar. Broj na desnoj strani predstavlja redni broj parametra a na levoj njegovu vrednost.
- Prvi parametar :00 je verzija programske šifre i samo je informativan.
- Pritiskom na desni broj (polje **CLOCK** na **sl. 14**) prelazi se na drugi parametar.

Instalaterski nivo (šifra 1166)

Po pravilnom unosu šifre za instalaterski meni, omogućen je dostup do sledećih parametara:

- :00 verzija programske šifre
- :13 vreme rada ventilatora – provetravanje 5..., 180, on
- :21 podešavanje brzine ventilatora 40, 45, ..., 95, 100
- :34 uključivanje PV funkcije YES/NO
- :39 podešavanje intervala aktivacije antilegionela programa 0..., 60
- :40 uključivanje provetravanja YES/NO
- :45 biranje prikaza temperature u °C ili °F

Podešavanje vremena rada ventilatora (parametar :13)

Kad je izabran parametar (:13), pritiskom na (+) ili (-) podešava se željeno vreme rada ventilatora (zadato: 30 minuta). Vreme do 30 minuta možete da podesite korakom po 5 min, a vreme preko 30 minuta korakom po 10 minuta. Za maksimalno podešavanje vremena se ispisuje ON, što predstavlja konstantan rad ventilatora do ručnog isključenja funkcije. Kad je vreme rada ventilatora podešeno, automatski se sprema nakon kratkog vremenskog zakašnjenja, odnosno nakon pritiska na polje **4**.

Podešavanje brzine ventilatora (parameter :21)

Kada je izabran parametar (:21), pritiskom na (+) ili (-) se podesi željena brzina ventilatora (40-100%). Na levoj strani (polje **5**) se ispiše brojičana vrednost podešavanja. Željenu brzinu ventilatora možete zapamtiti pritiskom na polje **4** ili će po kraćoj pauzi ona biti automatski zapamćena.

Uključivanje PV funkcija (fotovoltaika) (parametar :34)

Yes – funkcija je aktivirana

No – funkcija je deaktivirana

Antilegionela program (parametar :39)

- Izborom parametra (: 39), pritiskom na (+) ili (-), podešava se ponovljivost aktivacije antilegionela programa (0 do 60 dana). Sa leve strane (polje **5**) prikazuje se numerička vrednost podešavanja. Kada se podesi željena ponovljivost aktivacije programa antilegionela, ona se nakon kratkog odlaganja, automatski sačuva, odnosno se sačuva pritiskom na polje **4**. Ukoliko je vrednost parametra (:39) podešena na 0, program antilegionela je isključen.
- Fabričko podešavanje za aktiviranje antilegionela programa: svakih 14 dana rada toplotne pumpe, ako u proteklom 14-dnevnom periodu temperatura vode nije bar 1 sat neprekidno prelazila 65 °C.
- Antilegionela program radi samo kada je toplotna pumpa uključena. Kada je aktiviran, prikazan je simbol **17**.
- Antilegionela program možete uključiti ručno pritiskom na polje **15**.
- Delovanje antilegionela programa možete prekinuti isključivanjem pumpe na polju **9**.

Upozorenje: Nakon zagrevanja u programu antilegionela je temperatura vode u kotlu 65 °C ili više, bez obzira na podešenu temperaturu uređaja.

Uključivanje provetravanja (parametar :40)

Yes – funkcija je aktivirana

No – funkcija je deaktivirana

Izbor prikaza temperature (parametar :45)

Kad je izabran parametar (:45), pritiskom na (+) ili (-) birate način prikaza temperature u °C ili °F (zadata vrednost je °C). Kad je željeni način prikaza temperature izabran, automatski se sprema nakon kratkog vremenskog zakašnjenja, odnosno pritiska na polje **4**.

Provetravanje

- Uključenje funkcije je omogućeno kratkim pritiskom na polje **2**. Funkcija se automatski isključuje nakon isteka vremena podešenog na parametru :13 (zadato 30 minuta, vidi podešavanje vremena rada ventilatora, parametar :13).
- Simbol **2** je aktivan i vidljiv.
- U slučaju ponovljenog kratkog pritiska se funkcija provetravanja isključuje.
- U slučaju isključivanja toplotne pumpe prekidačem **on/off** se funkcija isključuje.
- U slučaju prekida napajanja električnom energijom tokom aktivne funkcije provetravanje, prilikom ponovnog priključenja napajanja funkcija provetravanje nastavlja do isteka podešenog intervala.
- U slučaju bilo kakve greške se funkcija isključuje.
- Funkciju provetravanja je nemoguće uključiti:
 - U slučaju prijavljivanja bilo kakve greške/kvara
 - U slučaju izvođenja antilegionele
 - U toku odmrzavanja

Rezervni režim (modeli ZG i ZGNT)

- Uključivanje funkcije je moguće dužim pritiskom na polje **2**.
- Simbol **3** je vidljiv.
- Rezervni režim predstavlja način rada s grejačima i upotrebljava se onda kada se na agregatnom delu prepozna greška delovanja. Voda se zagreva s grejačima do prethodno nameštene temperature.
- Isključivanje funkcije je moguće dužim pritiskom na polje **2**.
- U slučaju uključivanja rezervnog režima odmah morate kontaktirati servis.

Signalizacija rada

Antilegionelni program:

- program uključen – kontrolno polje **17** je prikazano
- program isključen – kontrolno polje **17** nije prikazano

Električni grejač:

- grejač uključen – kontrolno polje **14** je prikazano
- grejač isključen – kontrolno polje **14** nije prikazano

Toplotne pumpe:

- toplotna pumpa zagreva vodu – kontrolno polje **16** je prikazano
- toplotna pumpa ne zagreva vodu – kontrolno polje **16** nije prikazano

Uključivanje/Isključivanje:

- toplotna pumpa uključena – pored polja **9** su na ekranu vidljiva i druga polja
- toplotna črpalka isključena – na ekranu je vidljivo samo polje **9**

Odmrzavanje:

- toplotna pumpa je u režimu odmrzavanja – kontrolno polje **19** je prikazano
- toplotna pumpa nije u režimu odmrzavanja – kontrolno polje **19** nije prikazano

Uključivanje/isključivanje ventiliatora:

- ventilator radi – kontrolno polje **20** je prikazano
- ventilator ne radi – kontrolno polje **20** nije prikazano

Uključivanje provetravanja (kratak pritisak na polje **2**):

- uključivanje provetravanja - kontrolno polje **2** je prikazano

Uključivanje rezervnog načina (dug pritisak na polje **2**):

- rezervni režim uključen - kontrolno polje **3** je prikazano
- rezervni režim isključen - kontrolno polje **3** nije prikazano

FUNKCIJA PV (PHOTOVOLTAIC)

- PV funkcija je aktivna u slučaju sklopljenog beznaponskog kontakta među prekidačima 1 i 2 (slika. 17).
- U slučaju sklopljenog beznaponskog kontakta među prekidačima 1 i 2 je na ekranu prikazano polje 1.
- Za sklapanje beznaponskog kontakta je potrebno s fotovoltaiikom osigurati 800W električne moći.
- Fabrički je funkcija neaktivna.
- Funkcija se aktivira u instalacionom meniju podešavanjem parametra 34.
- Funkcija ima prioritet pred časovnim podešavanjem rada!
- Funkcija ne utiče na sigurnosno uključivanje!
- U slučaju antilegionelnog načina rada se izvede antilegionelni ciklus bez obzira na stanje kontakta.

Radna funkcije (u slučaju da je funkcija aktivirana):

- kontakt uključen - rad toplotne pumpe je omogućen. Toplotna pumpa zagrejava vodu do maksimalne temperature zagrevanja TP (gledaj tabelu tehničkih podataka). Grejač se ne aktivira.
- kontakt isključen - rad toplotne pumpe je omogućen. Toplotna pumpa održava temperaturu vode na 40°C.

Skidanje EPP servisnog poklopca

Modeli TCX30XXXX

1. Povlačenjem s donje strane odstranimo kraći deo EPP servisnog poklopca.
 2. Povlačenjem s donje strane odstranimo duži deo EPP servisnog poklopca.
- Ponovno nameštanje poklopca obaviti obrnutim redosledom.

Modeli TCX20XXXX

Gledaj tačku 2, navedenu kod modela TCX30XXXX.

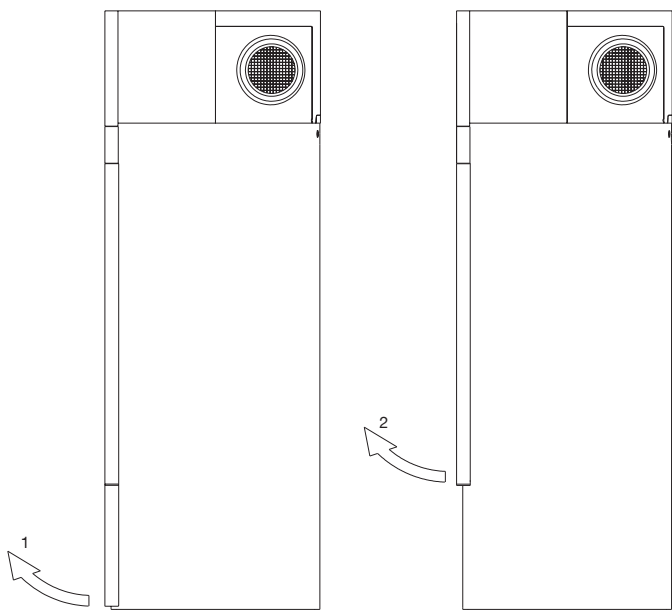

Sl. 15: Skidanje EPP servisnog poklopca

Priključivanje prepoznavanja PV (photovoltaic)

Povezivanje PV modula na toplotnu pumpu sme priključiti samo za to osposobljeni stručnjak. Na pozadini toplotne pumpe, ispod priključnog kabla je pripremljen ulaz za priključivanje PV funkcije. Mesto ulaza je prikazano na **sl. 16**. Za priključivanje upotrebite priključni kabl minimalnog preseka $0,5 \text{ mm}^2$ (H05VV-F 2G $0,5 \text{ mm}^2$) i maksimalnog spoljašnjeg preseka 10 mm , da bi to učinili morate prvo odstraniti EPP servisni poklopac. Način odstranjivanja je opisan u prethodnom poglavlju.

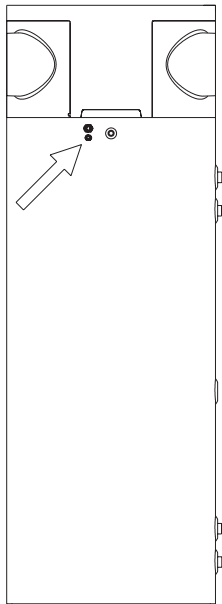

Sl. 16: Mesto ulaza za priključivanje prepoznavanja PV (photovoltaic)

Priključni kabl priključite na prekidač koji se nalazi ispod upravljačke jedinice. Mesto priključivanja je označeno oznakom PV. Upotrebite mesta 1 i 2.

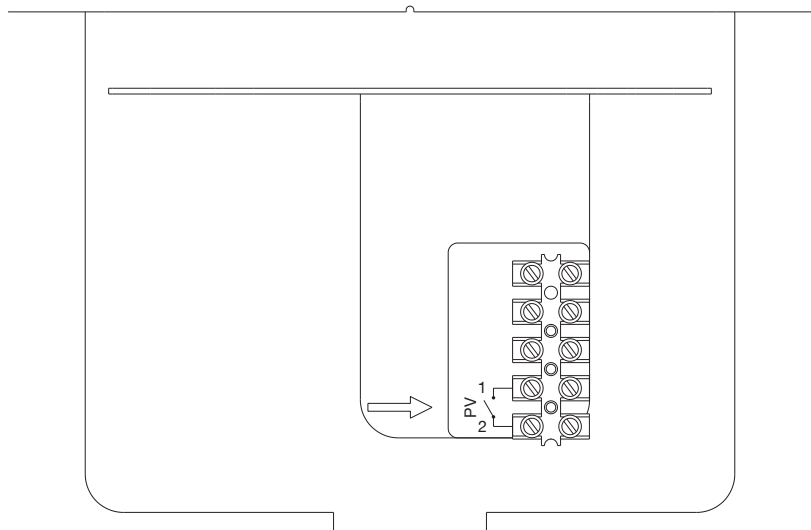

Sl. 17: Priključivanje prepoznavanja PV (photovoltaic)

UPOTREBA I ODRŽAVANJE

Bojler s toplotnom pumpom je pripremljen za upotrebu po priključivanju na vodovod i druge izvore grejanja. Kada postoji opasnost da bi voda u bojleru mogla smrznuti, pustite je da isteče. To učinimo tako da otvorimo ručicu za toplu vodu na jednoj od baterija za mešanje koja je priključena na bojler. Vodu iz bojlera ispuštimo kroz za to predviđeni ispusni ventil na dovodnoj cevi.

Spoljašnjost toplotne pumpe čistite mekom krpom i blagim tečnim sredstvima za čišćenje. Ne koristite sredstva za čišćenje koja sadrže alkohol ili abrazive. Kad je toplotna pumpa izpostavljena prašini se lamele isparivača dosta brzo mogu zapuštiti, što štetno utiče na njen rad.

Redovnim servisnim pregledima ćete osigurati besprekoran rad i dug životni vek bojlera s toplotnom pumpom. Garancija za proizvod važi u skladu sa uslovima navedenim u izjavi o garanciji.

Uprkos pažljivoj proizvodnji i kontroli, prilikom rada toplotne pumpe može doći do smetnji i kvarova koje mora popraviti ovlašćeni servis.

Pre prijave mogućih kvarova proverite:

- Da li je sa dovodom električne energije sve u redu?
- Da li vazduh na izlazu ima prepreke (isparivač može zamrznuti) ?
- Da li je temperatura u okolnoj sredini preniska (isparivač može zamrznuti)?
- Da li se ne čuje rad kompresora i ventilatora?

 **Molimo Vas da eventualne kvarove na grejaču i toplotnoj pumpi ne popravljate sami nego da o njih obavestite najbližu servisnu službu.**

SMETNJE U RADU

Uprkos pažljivoj proizvodnji i kontroli, prilikom rada toplotne pumpe može doći do smetnji i kvarova koje mora popraviti ovlašćeni servis.

Oznaka grešaka























- U slučaju greške na aparatu, on počne piskati i treptati u polju **4**. Pritiskom na polje **4** sa na polju **12** ispiše šifra greške.

Greška	Opis greške	Rešenje
E004	• Zamrzavanje. Greška se pojavi kad je temperatura u toplotnoj pumpi niža od 4 °C.	• Pozovite servis.
E005	• Pregrevanje (temperatura > 85 °C, otkazivanje elektronskog regulatora).	• Isključite toplotnu pumpu iz električne mreže, pozovite servis.
E007	• Greška senzora volumena i/ili temperature.	• Pozovite servis.
E042	• Greška funkcije antilegionele.	• Pritiskom na polje 4 izbrišete grešku.
E247	• Greška odmrzavanja.	• Automatski se uključi kod zagrevanja električnim grejačem. Po brisanju greške se ponovo omogućiti rad agregata.
E361	• Greška senzora okolnog vazduha.	• Pozovite servis (automatski pređe na grejanje električnim grejačem).
E363	• Greška senzora odmrzavanja.	• Pozovite servis (automatski pređe na grejanje električnim grejačem).

PRIDRŽAVAMO PRAVO DO PROMENA KOJE NE UTIČU NA FUNKCIONALNOST APARATA.

Uputstva za upotrebu možete naći na našoj internetnoj strani <http://www.gorenje.com>.

WARNINGS!

-  The appliance may be used by children aged 8 and older and persons with physical, sensory or mental disabilities or lacking experience or knowledge, if they are under supervision or taught about safe use of the appliance and if they are aware of the potential dangers.
-  Children should not play with the appliance.
-  Children should not clean or maintain the appliance without supervision.
-  In time of transport, the heat pump must be placed in the upright position and can be leant up to 35° in all directions upon exception.
-  The heat pump must not be placed in a closed space, containing corrosive and explosive materials.
-  The connection of the heat pump to the power supply must be performed in accordance with the standards for electrical installations. An appliance for the disconnection from the electrical network must be installed between the heat pump and the electrical network in accordance with the national installation regulations.
-  In avoidance of aggregate damage the heat pump must not operate without water in the tank.
-  The installation should be performed in accordance with the valid regulations and the instructions of the manufacturer. It should be performed by a professionally trained installation expert.
-  It is obligatory to install a safety valve with a rated pressure of 0.6 MPa (6 bar) on the inlet pipe of the heat pump of the closed pressure system to prevent the elevation of pressure in the tank by more than 0.1 MPa (1 bar) above the rated pressure.
-  Water may drip from the outlet opening of the safety valve, so the outlet opening should be set to atmospheric pressure.
-  The outlet of the safety valve should be installed facing downwards and in a non-freezing area.
-  To ensure proper functioning of the safety valve, the user should perform regular controls to remove limescale and make sure the safety valve is not blocked.
-  Do not install a stop valve between the heat pump and the safety valve, because it will impair the pressure protection of the storage tank!
-  Elements of the electronic control unit are under voltage even after the heat pump has been switched off (9).
-  The storage tank is protected in case of failure of the operating thermostat with an additional thermal cut-out. In case of thermostat failure water in the storage tank may reach the temperature of up to 130°C in accordance with safety standards. The possibility of such temperature overload should be taken into consideration in the execution of plumbing.
-  Should you choose to disconnect the power, the storage tank should be drained thoroughly before the onset of freezing conditions.
-  Water from the storage tank is drained through the inlet pipe of the tank. For this purpose, a special fitting (T-fitting) with an outlet valve must be mounted between the safety valve and the inlet pipe.
-  Please, do not try to fix any defects of the heat pump on your own. Call the nearest authorised service provider.
-  Connection of the heat pump to the same pipeline with the kitchen vent, the ventilation system of smaller apartments is not allowed.
-  The decline in temperature of an additional heating source and the enabled water circulation via the heat exchanger can cause an uncontrolled removal of heat from the water tank. When connecting to other heating sources it is necessary to ensure proper temperature regulation of the additional heating source.
-  When connecting to sources of solar energy as an external heating source the aggregate of the heat pump must be disconnected. The combination of both heating systems can lead to overheating of water and consequently to excessive pressure.
-  Circulation leads to additional heat loss in the water tank.
-  With models without the heater (Models Z) the water tank with the heat pump is without freezing protection!
-  This product contains fluorinated greenhouse gases. Hermetically sealed.

 Our products incorporate components that are both environmentally safe and harmless to health, so they can be disassembled as easily as possible and recycled once they reach their final life stage.

Recycling of materials reduces the quantity of waste and the need for production of raw materials (e.g. metals) which requires a substantial amount of energy and causes release of harmful substances. Recycling procedures reduce the consumption of natural resources, as the waste parts made of plastic and metal can be returned to various production processes.

For more information on waste disposal, please visit your waste collection centre or the store where the product was purchased.

Dear buyer, thank you for purchasing our product.

PRIOR TO THE INSTALLATION AND FIRST USE OF THE HOT WATER STORAGE TANK WITH THE HEAT PUMP, PLEASE READ THESE INSTRUCTIONS CAREFULLY.

This storage tank has been manufactured in compliance with the relevant Standards, which allow the manufacturer the use of the CE sign. The technical characteristics of the product are listed on the label attached to the protective cover.

The connection of the storage tank with the heat pump to the plumbing and power networks must be carried out by qualified staff only. **Any intervention performed on the tank during service or removal of limescale must be carried out by an authorised service provider.** Be especially careful when following instructions for potential errors and safe use of the heat pump.

Store this booklet for times of doubt upon the functioning or maintenance.

The installation manual is available on our webpage <http://www.gorenje.com> or the webpages per country in the service and support section.

Authorised maintenance personnel are available for occasional maintenance. They will help you with their vast experience.

The hot water storage tank is designed in a manner which allows using the following heating sources:

- Central heating storage,
- Solar power,
- Electric heater.

USE



This unit is designed for production of sanitary water in households and at premises where daily consumption of hot water (50 °C) does not exceed 400 l to 700 l. **The set temperature should suffice actual needs. Recommended temperature settings are between 45 and 55 °C. Higher temperatures are not recommended as they reduce the efficiency (COP) and extend the time of heating or increase the number of operating hours.** Because during its operation the heat pump cools its surroundings, the usefulness of the heat pump is doubled (heating water – cooling air). The operation of the heat pump is completely automatic.

The appliance must be connected to water supply mains and to the power supply grid. The air intake and air exhaust may also be provided by designing the inlet and outlet drain from and to the adjacent room. For easier control, it is recommended to leave enough room above the appliance (Fig. 2). The heat pump may not be used for purposes other than those defined in these Instructions. The unit is not designed for industrial use or use in rooms where corrosive or explosive substances are present. The manufacturer shall not assume any liability for damages caused by incorrect installation or misuse that are not in compliance with the Instructions for installation and use.

The **instructions for use** are a component and important part of this product and must be delivered to the customer. Read the warnings carefully, as they contain important directions related to safety during operation, use and maintenance. Keep these Instructions for later use.

The marking of the heat pump is stated on the nameplate located on the bottom side of the unit, between both inlet pipes for sanitary water.

Once the packaging is removed, check the contents. When in doubt, contact your dealer. Never let children play with the packaging parts (clamping, plastic bags, expanded polystyrol, etc.) – potential risk. Make sure to remove and dispose of the packaging safely and in an environmentally friendly way.

-  **The appliance is not intended for use in closed space, containing corrosive and explosive materials.**
-  **In time of transport, the heat pump must be placed in the upright position and can be leant up to 35° in all directions upon exception. Please make sure, no damage of the casing and other vital parts of the appliance occurs during transport.**

STORAGE AND TRANSPORT

Store the heat pump in an upright position, in a clean and dry place.

TECHNICAL CHARACTERISTICS

KEY TIPE

TCX 306 Z XY

- Y = low temperature operation **NT** - if there is no sign, there is no low temperature
 X = installed heater **G** - if there is no sign, there is no heater
 Heat pump with an integrated aggregate and one exchanger

Type		TCX 200 Z XY	TCX 201 Z XY	TCX 300 Z XY	TCX 306 Z XY
Use profile		L	L	XL	XL
Energy efficiency class ¹⁾		A+	A+	A+	A+
Energy efficiency of water heating η_{wh} ¹⁾	%	128,5	127,0	136,0	134,4
Annual electrical energy consumption ¹⁾	kWh	797	806	1231	1246
Daily electrical energy consumption ¹⁾	kWh	3,762	3,813	5,707	5,787
Set thermostat temperature	°C	55	55	55	55
Level of indoor sound power ⁵⁾	dB (A)	59/58	59/58	59/58	59/58
Smart value		0	0	0	0
Storage volume	l	208,0	194,0	295,0	276,0
Mixed water at 40 °C V40 ²⁾	l	260	248	395	368
Potential safety measures (assembly, installation, maintenance)		Compulsory use of a safety valve with the pressure connection.			
Technical characteristics					
Heating time A15 / W10-55 ⁴⁾	h:min	05:21	05:13	08:32	08:00
Heating time A7 / W10-55 ⁵⁾	h:min	06:24	06:06	09:40	09:39
Energy consumption in the selected cycle of emissions A15 / W10-55 ⁴⁾	kWh	3,71	3,86	5,75	5,75
Energy consumption in the selected cycle of emissions A7 / W10-55 ⁵⁾	kWh	3,82	3,97	5,80	5,96
COP _{DHW} A15/W10-55 ⁴⁾		3,25	3,12	3,42	3,38
COP _{DHW} A7/W10-55 ⁵⁾		3,10	3,06	3,34	3,30
Power in standby mode ⁵⁾	W	24	26	18	20
Refrigerating agent		R134a	R134a	R134a	R134a
Quantity of refrigerant	kg	1,100	1,100	1,100	1,100
Global Warming Potential		1430	1430	1430	1430
Carbon dioxide equivalent	t	1,573	1,573	1,573	1,573
Operation area regular model	°C	7 ÷ 35	7 ÷ 35	7 ÷ 35	7 ÷ 35
Operation area NT ⁶⁾	°C	-7 ÷ 35	-7 ÷ 35	-7 ÷ 35	-7 ÷ 35
Area of airflow	m ³ /h	220-450	220-450	220-450	220-450
Max acceptable pressure drop in the pipeline (volumetric flow rate of a at 330 m ³ /h) (60%)	Pa	100	100	100	100
Electrical characteristics					
Specified power of the compressor	W	490	490	490	490
Heater power X ⁷⁾	W	2000	2000	2000	2000
Maximum connection power without heater/with heater	W	490/2490	490/2490	490/2490	490/2490
Voltage	V/Hz	230/50	230/50	230/50	230/50
Electrical protection	A	16	16	16	16
Moisture protection		IP24	IP24	IP24	IP24
Water tank					
Anti-corrosion protection of tank		Stainless steel			
Nominal pressure	MPa	0,6/0,9/1,0	0,6/0,9/1,0	0,6/0,9/1,0	0,6/0,9/1,0
The highest water temperature heat pump	°C	65	65	65	65
The highest water temperature electrical heater ⁷⁾	°C	75	75	75	75
Connection measurements					
Total height	mm	1540	1540	1960	1960
Width	mm	670	670	670	670
Depth	mm	690	690	690	690
Inlet/outlet water connections		G1	G1	G1	G1
Inlet/outlet air connection dimensions	mm	Ø160	Ø160	Ø160	Ø160
Heating area PT - bottom	m ²	/	1,45	/	1,6
Exchanger connectors		-	G1	-	G1
Weight/Filled with water	kg	104/116/312	133/145/327	123/135/418	177/189/453
The temperature of the heating medium in the heat exchanger	°C	/	5 ÷ 85	/	5 ÷ 85
Transport data					
Packaging	mm	800x800x1765	800x800x1765	800x800x2155	800x800x2155

¹⁾ directive 812/2013, 814/2013, EN16147:2011. Average climate conditions

²⁾ in accordance with EN16147:2011

³⁾ in accordance with EN12102:2013 (60% fan speed - outside air/40% fan speed - ambient air)

⁴⁾ inlet air temperature 15°C, 74% humidity, water temperature between 10 and 55°C in accordance with EN16147:2011

⁵⁾ inlet air temperature 7°C, 89% humidity, water temperature between 10 and 55°C in accordance with EN16147:2011

⁶⁾ low temperature mode, stated with the typical sign NT - if there is no sign, there is no low temperature operation

⁷⁾ installed heater, stated with the typical sign G - if there is no sign, there is no heater

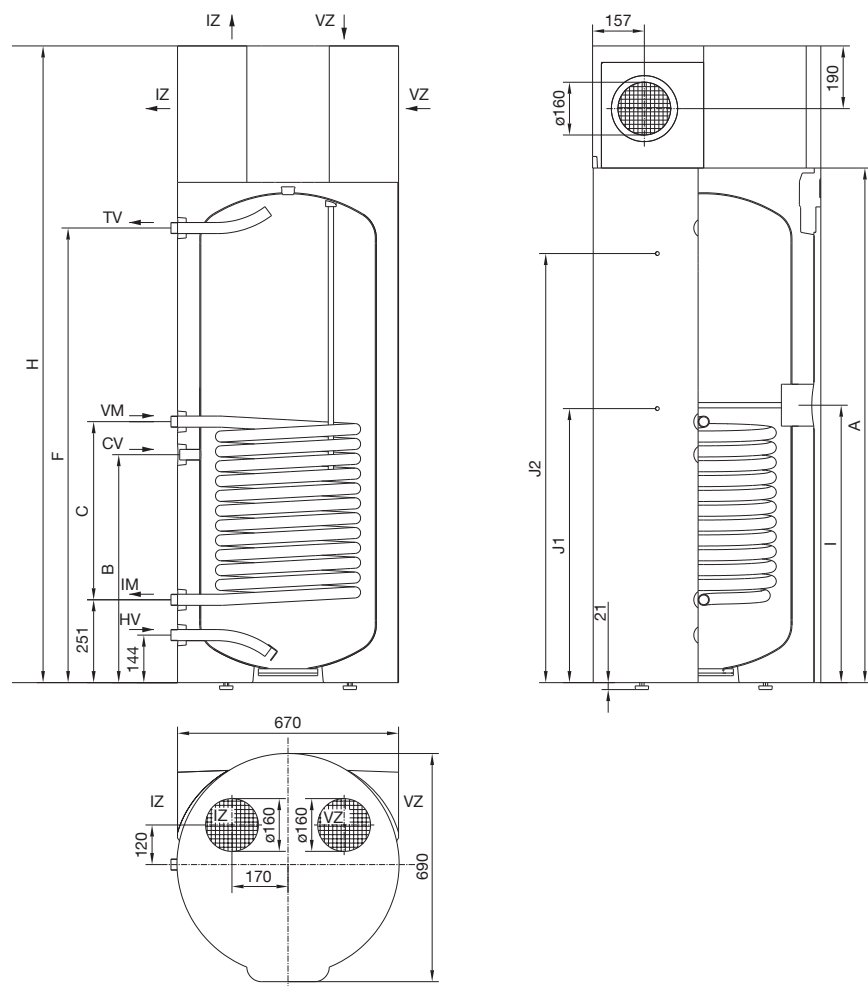
**LEGEND**

PT	Heat exchanger
HV	Cold water inlet (H - blue rosette)
IM	Outlet PT (black rosette)
CV	Circulation pipeline (black rosette)
VM	Inlet PT (black rosette)
TV	Hot water outlet (T - red rosette)
J1	Sensor pipe
J2	Sensor pipe
VZ	Air inlet
IZ	Air outlet

	TCX 200 Z XY	TCX 201 Z XY	TCX 300 Z XY	TCX 306 Z XY
A (mm)	1170	1170	1560	1560
B (mm)	580	580	690	690
C (mm)	/	620	/	540
F (mm)	975	975	1375	1375
H (mm)	1540	1540	1930	1930
I (mm)	615	615	840	840
J1 (mm)	/	/	/	790
J2 (mm)	/	900	/	1300
HV	G1	G1	G1	G1
IM	/	G1	/	G1
CV	G3/4	G3/4	G3/4	G3/4
VM	/	G1	/	G1
TV	G1	G1	G1	G1

Figure 1: Connection and installation tank dimensions [mm]

OTHER HEATING SOURCES - SENSOR INSTALLATION

On the left side of the hot water storage tank are two openings (J1, J2), where the sensors for the control system of the connection of the hot water tank to other heating sources. The maximum diameter of the probe is 8 mm. The length of the sensor tube is 180 mm. Insert the sensor into the tube and attach it:

- if you install the sensor into a higher position, the thermostat will respond faster, the operation period of the circulation pump will be shorter, the difference between the water temperature in the storage tank and the temperature of the heating source after the shutdown of the thermostat will be higher. Consequently, the quantity and the temperature of hot water in the storage tank will be lower.
- if you install the sensor in a lower position, the operation period of the circulation pump will be longer, the difference between the water temperature in the storage tank and the temperature of the heating source after the shutdown of the thermostat will be lower. Consequently, the quantity and the temperature of hot water in the storage tank will be higher.

INSTALLATION OF THE HOT WATER STORAGE TANK WITH THE HEAT PUMP

The heat pump can be used using the ambient air or air from other premises.

To prevent pressure depression in the building, fresh air must be regularly supplied to the premises. The desired rate of air exchange for a residential building is 0.5. This means that the entire quantity of air in the building is exchanged every two hours.

OPERATION USING AMBIENT AIR (Model ZG and Z)

In this type of operation, the device heats domestic water using only the amount of energy generated by the air from the room where the device is installed. The heat pump must be installed in a dry, frost-free room, possibly in the vicinity of other heating sources with the temperature ranging between 7 and 35°C and a minimum volume of 20 m³.

For optimal performance of the heat pump, we recommend a sufficiently large and well ventilated room with the temperature ranging between 15 °C and 25 °C.

When selecting a place for installation, particular attention should be paid that the selected air intake location is dust free, because dust has adverse effects on the heat pump performance. Because pressure drop does not occur with the ambient air operation it is reasonable to reduce the fan speed from factory settings of 60% to 40% to reduce noise (See further chapters).

There are several inlet and outlet openings possible with this model (See figure).

Elbows are more suitable for ambient air operation and must be installed on the heat pump and turned so that they prevent the mixing of air.

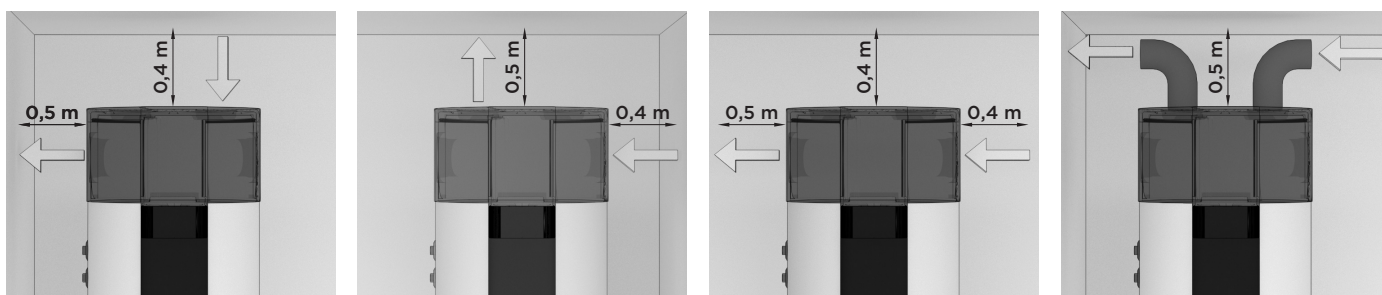

Figure 2: Options of inlet and outlet openings

OPERATION USING AIR FROM OTHER PREMISES (Model ZGNT)

In this type of operation, the heat pump uses air from other premises via a pipeline system. It is advisable to insulate the pipeline system to prevent the formation of condensate. In case of using air from outside, the external part must be covered so as to prevent the intrusion of dust or snow into the appliance.

To make sure the operation of the pump is effective at all times, you can install dampers to take air from the premises and then return it either to the premises or outside. The temperature of the taken air must correspond with the standards of the specification of the product (see table with technical characteristics).

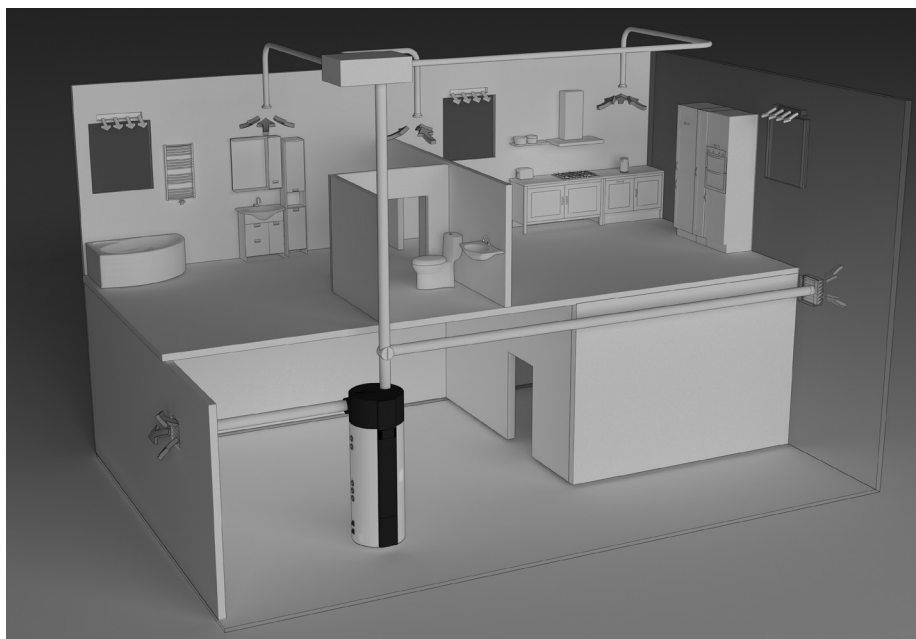

Figure 3: Operation using air from other premises

DETERMINING PRESSURE LOSS IN THE AIR INLET AND OUTLET PIPELINE SYSTEM

The heat pump offers various installation options of connection of the air inlet and outlet pipelines. We recommend the connection options, which enable the simplest installation of the appliance to the pipeline system. When designing the pipeline system for air inlet and outlet to and from the heat pump it is essential to consider the aerodynamic characteristics of the heat pump fan, where the static pressure loss occurs.

The aerodynamic characteristics are displayed in a graph as a pressure drop in relation to airflow. The operating point of the heat pump fan is at 100 Pa of static pressure or at airflow of 330 m³. Working drop of static pressure in an air pipeline of heat pumps is considered $\Delta p = 100$ Pa. If the calculations show higher pressure drops, the fan speed can be increased. The increase of the fan speed is effective up to 80%. The airflow does not increase above this level, therefore we advise against further increase for it will only cause higher levels of noise.

The diagram shows the following areas:

- High-efficiency area - area of high airflow rates (over 300 m³) requires lower pressure drops (pipeline free or short pipeline) and fan settings to 60% or 80%.
- Middle-efficiency area - area of middle airflow rates (between 200 and 300 m³/h), 40% fan settings, minimum pressure drop, 60% or 80% of settings and pressure drops between 50 and 300 Pa.
- Expanded area for higher ambient temperatures - a wider range of settings and high pressure drops. **These settings may be in use only with air temperature over 20°C**, otherwise an efficiency decline occurs.

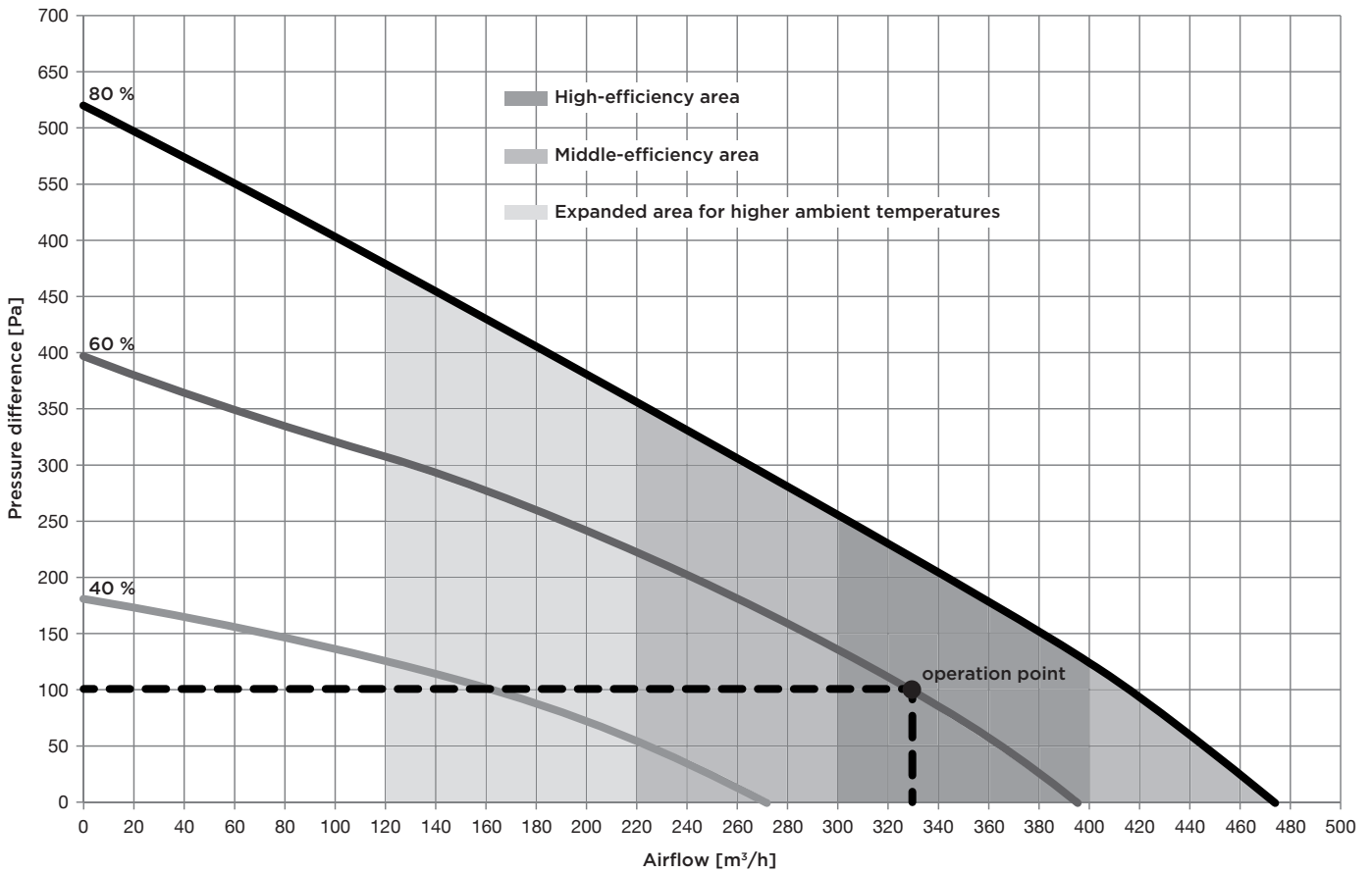
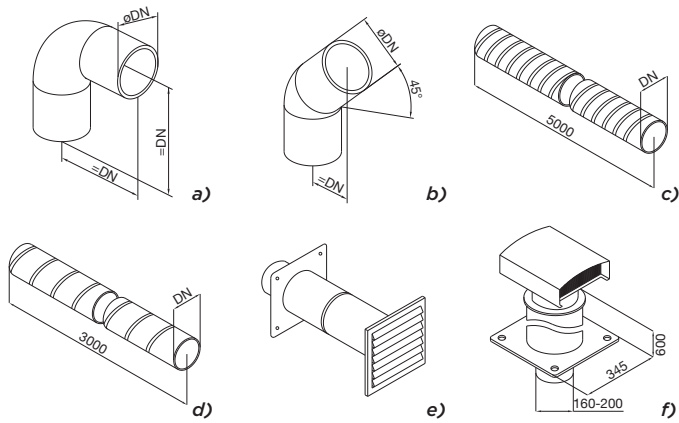

Figure 4: Aerodynamic characteristics of heat pump fan

Values of total static pressure drop are calculated by adding up pressure drops of each individual element, installed in the air pipeline system. Values of pressure drops of each individual element (diameter 150 mm) are presented in the following table.



Element types and their pressure drops.

Element type	Values of pressure drops of each individual element
a) Bend 90°	5 Pa
b) Bend 45°	3 Pa
c) Flexible hose	5 Pa/m
d) Spiro hose	3 Pa/m
e) Suction grille	25 Pa
f) Top exhaust air outlet	10 Pa

Figure 5: Diagram of basic elements of the air inlet and outlet pipeline system

The calculations of the pressure values are informative. More accurate calculations of airflows require more detailed characteristics of individual elements or information from the developer. After the installation we recommend measurements of the airflow in the pipeline system. Values of total static pressure drop are calculated by adding up pressure drops of each individual element, installed in the air pipeline system. Recommended nominal operation is at the sum total of ca. 100 Pa. In case of airflow decrease COP drops.

Calculation example

	Number of elements	Δp (Pa)	$\Sigma \Delta p$ (Pa)
Bend 90°	4	5	20
Flexible hose	9	5 Pa/m	45
Suction grille	1	25	25
Top exhaust air outlet	1	10	10
Sum total			100

⚠ Connection of the heat pump to the same pipeline with the kitchen vent, the ventilation system of smaller apartments is not allowed.

During operation of the heat pump condensate forms in the aggregate. The condensate should be drained to the sewage system via flexible tube Ø16mm on the rear side of the heat pump. The quantity of condensate depends on air temperature and humidity or air.

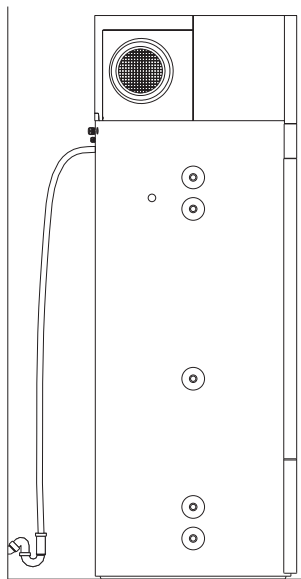

Figure 6: Connection to water supply mains - condensate outlet

To reduce noise and vibrations of the installed fan take the following steps to prevent the noise and vibrations to be transmitted through walls into rooms, where it would be disturbing (bedrooms, restrooms):

- install flexible connectors for hydraulic jacks
- install flexible pipes for air inlet and outlet
- isolate the vibrations for wall transmitters
- provide silencers for air inlet and outlet
- air inlet and outlet pipes attach with vibration silencers
- predict isolation of vibrations via floor
- use support elements.

CONNECTION TO WATER SUPPLY MAINS

Connect the water pipeline system according to the attachment signs from the previous chapter.

Installing a safety valve is mandatory in order to assure safe operation. The valve prevents an increase of the pressure in the boiler by any more than 0.1 MPa (1 bar) above the nominal pressure. The outflow nozzle on the safety valve must have an outlet into the atmosphere. To assure correct operation of the safety valve, check the valve regularly and, if necessary, remove the limescale and check that the safety valve is not blocked. When checking the valve, push the lever or unscrew the nut of the valve (depending on the type of the valve) and open the drain from the safety valve. Water must flow from the valve nozzle, showing that the valve operation is faultless. During the heating of water, the water pressure in the hot water tank is increased up to the level present in the safety valve. Since the system prevents backflow of water into the water supply mains, water may be dripping from the outlet opening on the safety valve. The dripping water may be drained via trap into the drains; the trap is mounted under the safety valve. The outlet pipe, which is mounted under the safety valve, must be directed downwards, in a place with a temperature above freezing.

If the installation does not allow draining of the water from the safety valve into the drains, dripping can be avoided by installing an expansion vessel onto the heat pump inlet pipe. The volume of the expansion vessel must be ca. 5% of the hot water tank volume.

The heat pump is designed for connection to indoor water supply mains without using the relief valve if the pressure in the supply mains is lower than prescribed on the appliance. If the pressure is higher, a relief valve needs to be installed so as to provide that the pressure at the inlet to the hot water tank does not exceed the nominal pressure.

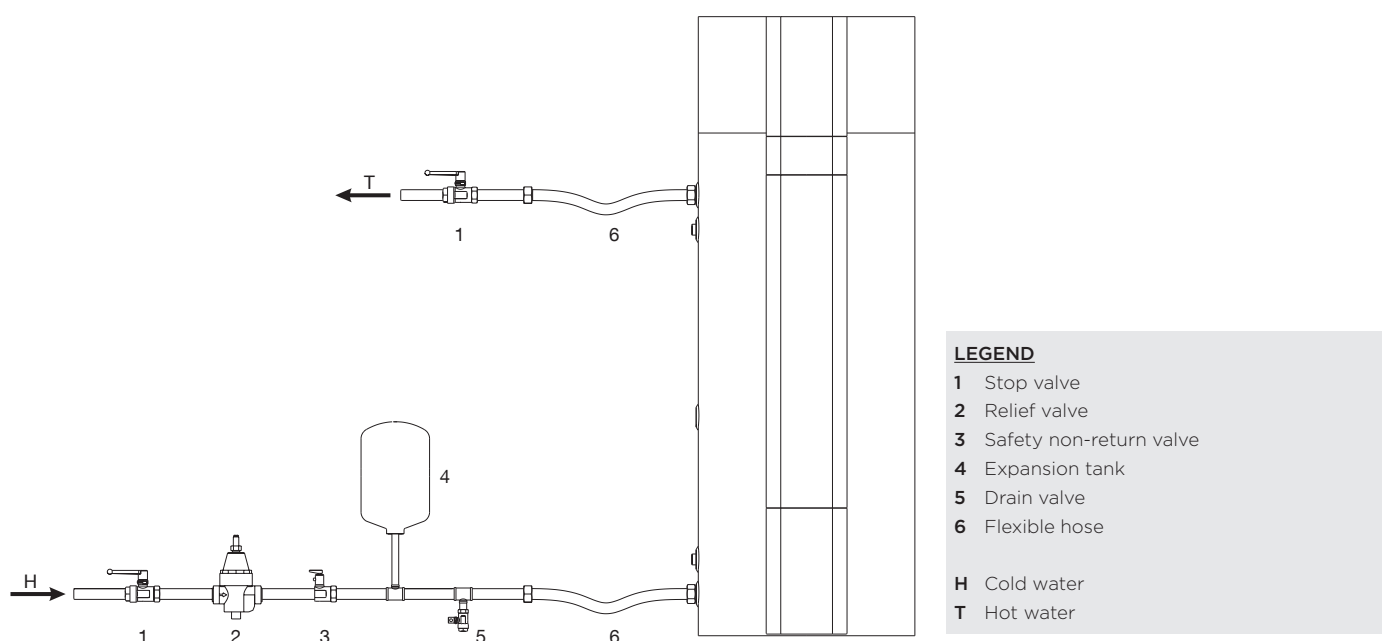

Figure 7: Closed pressure system

⚠ In avoidance of aggregate damage the heat pump must not operate without water in the tank.

CONNECTION TO OTHER HEATING SOURCES

The hot water storage tank with the heat pump is designed for the provision of domestic hot water through the heat exchanger with different heating sources (e.g. central heating, solar power, etc.).

Connection options to different heating sources are shown below.

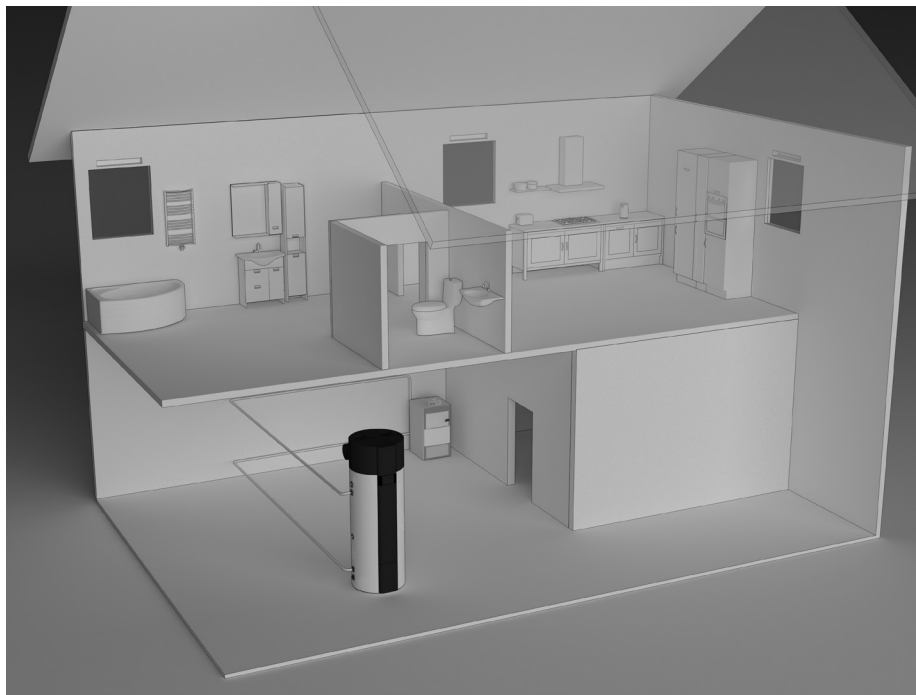

Figure 8a: Connection to the central heating

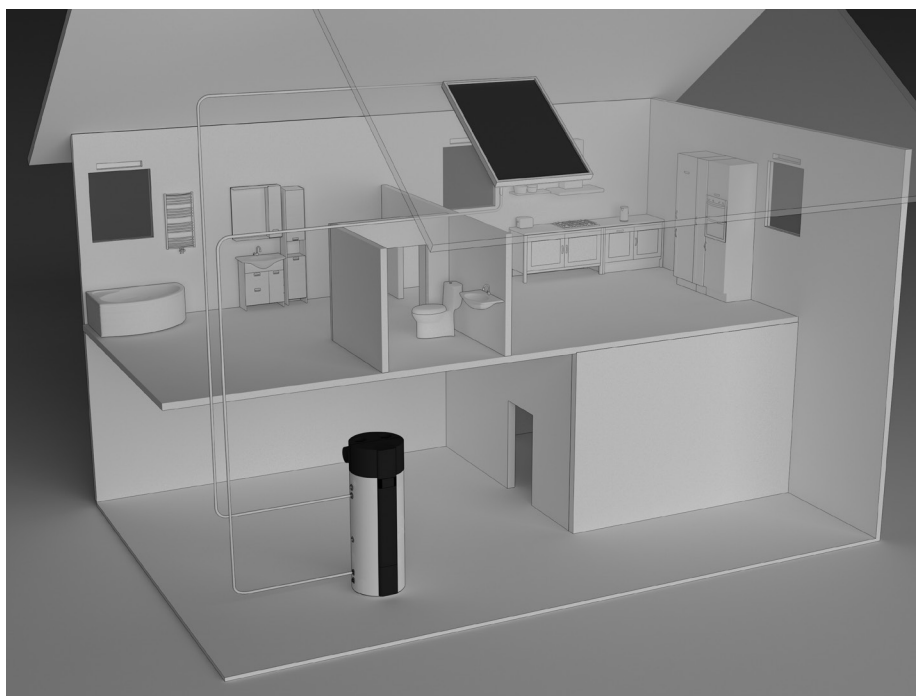

Figure 8b: Connection to the solar collector

- ⚠ With a temperature decline of an additional heating source and with an enabled water circulation through the heat exchanger proper temperature control of the additional source must be ensured.
- ⚠ If the additional energy source is solar power, the operation of the aggregate of the heat pump must be shut off. The combination of two heating sources can lead to overheating of the hot water and thus to excessive pressures.
- ⚠ The circulation pipeline causes additional temperature decline in the hot water storage tank.

CONNECTION TO THE POWER SUPPLY NETWORK

In order to connect the hot water storage tank with the heat pump to the power supply network first install an electrical socket suitable for the current load of 16 A.

Connecting the heat pump to the power supply network must take place in accordance with the standards for electric appliances. To comply with the national installation regulations, an all poles disconnect switch must be installed between the heat pump and the power supply network.

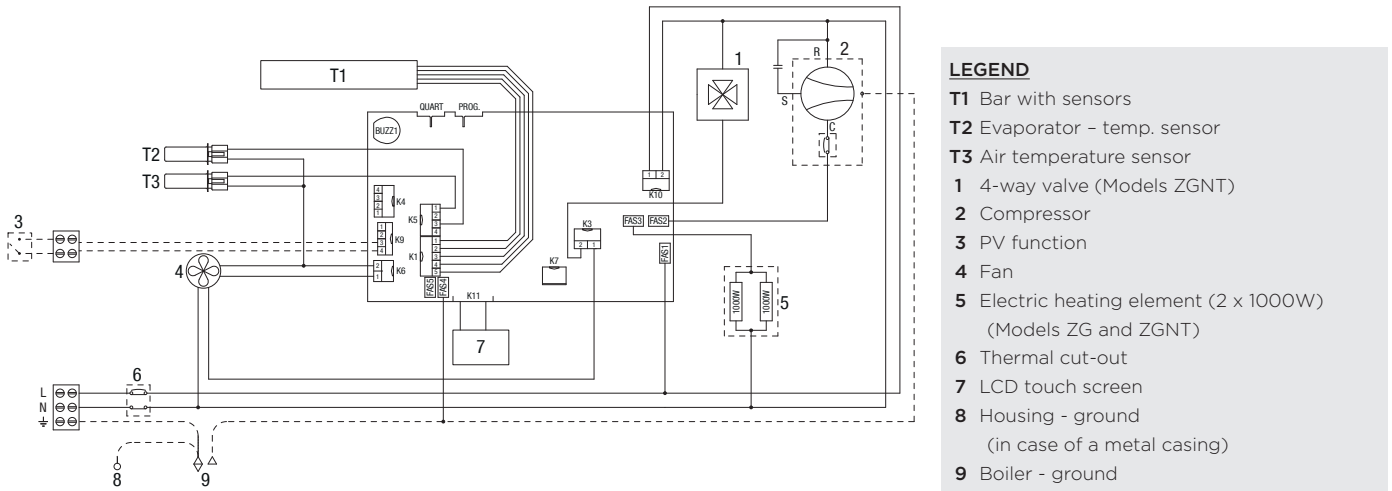

Figure 9: Connection to the power supply network

HEAT PUMP OPERATION

The heat pump can be operated using an LCD touch screen (Fig. 10). If you press anywhere on the screen, the screen lights up. When the screen is lit up, the operation fields are active.

When the heat pump is connected to the water and power supply mains and the boiler is filled with water, the heat pump is ready to be used. The heat pump heats the water in the range 10 °C - 65 °C. From 65 °C - 75 °C the water is heated by electrical heaters (models ZG and ZGNT).

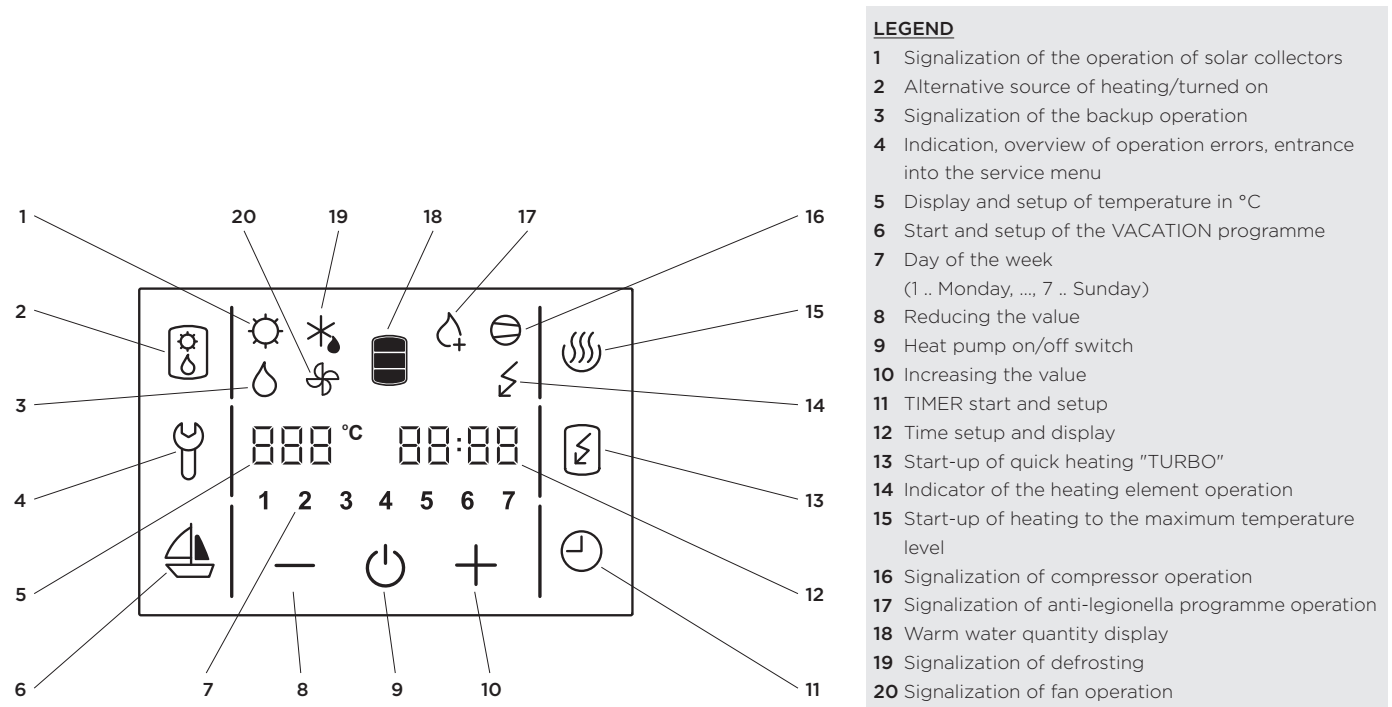

Figure 10: Operation display

Starting/stopping the heat pump

- **To start the heat pump, hold field no. 9.**

When the appliance is switched on, the fan starts first and operates for one minute (symbol no. **20** is displayed). If the temperature of inlet air is appropriate, the controlling unit switches on the compressor and the heat pump operates in normal mode (symbols **16** and **20** are displayed). The heat pump is on, the screen remains unlit and inactive.

In 60 seconds after the last touch of the screen, the illumination and activity of the screen are turned off, but that does not affect the operation of the heat pump. Pressing anywhere on the screen re-activates the screen and its illumination.

If trying to start up at a lower temperature, please see chapter "Operation at lower temperatures".

- **By holding field no. 9, the heat pump is switched off.**

The appliance stops functioning and the only field visible on the screen is field no. **9**. (If you switch off the heat pump for a longer period of time, the water must be drained from the pump if there is any danger of freezing).

Power failure protection

In case of power failure, the settings remain stored for up to 23 hours.

After restarting, the heat pump operates in the same mode it was operating in before the power failure.

Operation at lower temperatures

a) The ZGNT version

When the appliance is switched on, the fan starts first and operates for one minute (symbol no. **20** is displayed). If the temperature of inlet air is lower than -7°C , the fan is turned off. Domestic water is heated with heaters. The heat pump operates in the reserve mode (symbol no. **14** is displayed). The possibility of switching to normal mode is checked every 2 hours by switching on the fan for one minute. If the temperature of inlet air is higher than -7°C , the heat pump switches to normal mode of operation (symbols **16** and **20** are displayed). The heaters switch off. The heat pump is on, the screen remains unlit and inactive.

At lower air temperatures, the evaporator defrosting cycle is started if necessary. Symbol no. **19** is displayed on the screen. The fields **2**, **4**, **6**, **11**, **13** and **15** remain inactive. Defrosting takes place until the conditions for normal operation of the heat pump are achieved.

After successful defrosting, the heat pump returns to normal operation (symbols **16** and **20** are displayed).

If defrosting is unsuccessful, the controlling unit displays an error message. Field no. **4** starts flashing, accompanied by warning beeps. By pressing field no. **4** the warning beeps can be turned off. Error code E247 appears in field no. **12** and the pump switches automatically to heating with electric heaters. The screen displays symbol no. **14**. The error code can be deleted at any time by pressing field no. **4**. Field no. **12** resumes to displaying time.

b) The ZG version

When the appliance is switched on, the fan starts first and operates for one minute (symbol no. **20** is displayed). If the temperature of inlet air is lower than 7°C , the fan is turned off. Domestic water is heated with heaters. The heat pump operates in the reserve mode (symbol no. **14** is displayed). The possibility of switching to normal mode is checked regularly. If the temperature of inlet air is higher than 7°C the heat pump switches to normal mode of operation (symbols **16** and **20** are displayed). The heaters switch off. The heat pump is on, the screen remains unlit and inactive.

c) The Z version

When the heat pump is not equipped with a heater, certain functions (backup mode), described under **b)** cannot be used. In case of temperature increase or decline these pumps cannot heat water. The possibility of switching to the normal operation mode operation is cyclically checked.

 **With models without the heater (Models Z) the water tank with the heat pump is without freezing protection!**

Setting the clock and day of the week

- Hold field no. **12**, until field no. **7** shows a flashing number of the day of the week.
- By pressing **+** or **-** you can set the number of the day of the week (1 – Monday, ..., 7 – Sunday).
- Press field no. **12** again (flashing hour setting is displayed).
- By pressing **+** or **-** set the hour (by holding **+** or **-** you can speed up the setting).
- Press field no. **12** again.
- Flashing minute setting is displayed.
- By pressing **+** or **-** set the minutes (by holding **+** or **-** you can speed up the setting).
- The setting is stored when you press field no. **12**, or when the field stops flashing.

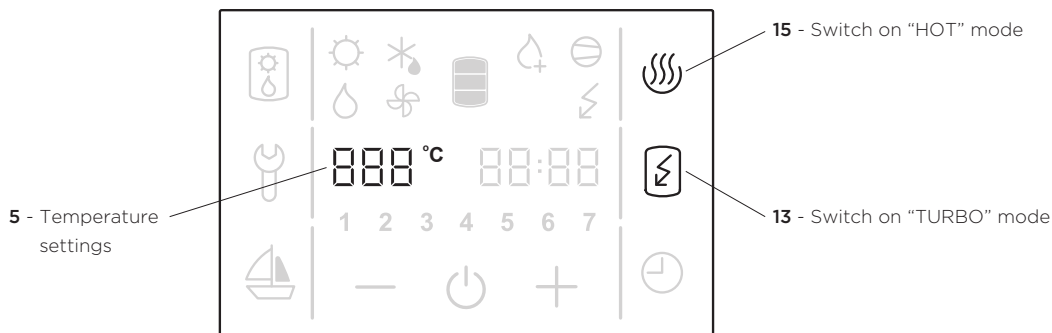

Figure 11: Temperature settings, switch on "TURBO" and "HOT" mode

Setting the temperature

- Press field no. **5** (the set temperature starts blinking).
- By pressing **+** or **-** you can change the temperature setting from 10 °C to 75 °C or 10 to 65 °C (Z models), preset to economic temperature of 55 °C.
- The setting is stored by pressing field no. **5** again, or when field no. **5** stops flashing. After a few seconds, the display shows the actual temperature. **The set temperature should suffice actual needs. Recommended temperature settings are between 45 and 55 °C. Higher temperatures are not recommended as they reduce the efficiency (COP) and extend the time of heating or increase the number of operating hours.**
- In case of power failure, the last stored value is restored.

Switching on the "TURBO" mode (Models ZG in ZGNT)



- If you need more warm water than the heat pump can heat up in a short period of time, press field no. **13** (switches on the "TURBO" mode). The heat pump and heater work simultaneously. The screen shows symbols no. **14**, **16** and **20**. When the temperature reaches 55 °C the heat pump returns to the mode used before the "TURBO" mode.
- With models without the heater the water is heated only by the heat pump. The function does not offer the option of accelerated heating.

Switching on the "HOT" mode

- If you want to heat the water to the maximum temperature of 75 °C, press field no. **15**. The heat pump will heat water to 55 °C. The screen displays symbols no. **16** in **20**. When the temperature in the boiler reaches 55 °C the electric heater turns on to heat the temperature up to 75 °C. The screen displays the symbol no. **14**. When the temperature reaches 75 °C the heat pump returns to the mode used before the "HOT" mode.
- With models without the heater the function is inactive

Display of the quantity of water in the heat pump

The display shows the symbol **18**:

-  - no warm water
-  - low quantity of warm water
-  - high quantity of warm water

Setting the vacation mode

In the vacation mode, you can set the number of days (maximally 100), when the heat pump shall maintain the minimal temperature of water (approximately 10 °C).

- Hold field no. **6** for a while (fields **5** and **6** start to flash).
- By pressing fields **+** or **-** you can set the number of vacation days shown in field no. **5**.
- By pressing field no. **6** again, or when field no. 6 stops flashing, the set number of days is stored.
- If you set the value to 0, then the heat pump will resume its normal operating mode after confirming the setting, and illumination of field no. **6** will turn off.
- After the set number of days has elapsed, the heat pump returns to the normal mode and illumination of field no. **6** turns off.

The Z version

With models without the heater the minimum temperature is provided only by heating with the heat pump. In case of higher or lower air temperatures from the temperatures of the heat pump operation the water will not heat.

 **With models without the heater (Models Z) the water tank with the heat pump is without freezing protection!**

Setting the TIMER mode

In the TIMER operating mode, you can set the times when the heat pump will start and stop. For each timer combination you can set up to three time periods in which the heat pump will not heat the water.

a) Setting the timer combinations

- Hold field no. **11** for a while (fields **7** and **11** start to flash).
- By pressing fields **+** or **-** choose among three timer modes of operation:
 - Timer mode of operation of the heat pump for the entire week (numbers 1-7 flash in field no. **7**),
 - Timer mode of operation of the heat pump for Monday to Friday and Saturday to Sunday (numbers 1-5 and then **6** and **7** flash in field no. **7**),
 - Timer mode of operation of the heat pump for each day at a time (individual numbers 1-7 flash in field no. **7**).
 Press field **+** or **-** to select each day of the week.
- To set the time, press field no. **12**.
- On the field no. **5**, the text 1OF appears and field no. **12** starts to blink.
- By pressing fields **+** or **-** set the time of shutdown.
- Press field no. **12** again.
- On the field no. **5**, the text 1ON appears and field no. **12** starts to blink.
- By pressing fields **+** or **-** set the time of start-up.
- By pressing field no. **12** again, you can use the above procedure to set the second and third period.
- If you do not want to set the second and third periods, confirm the setting by pressing field no. **11** or wait for field no. **12** to stop flashing and the setting to be saved automatically.
- To set the second and third periods, set the start and end of periods 2 and 3 and confirm the setting following the procedure described above by pressing field no. **11** or wait for field no. **12** to stop flashing and the setting to be saved automatically.
- To set the timer operating mode "for each day of the week" or "for the period from Monday to Friday and from Saturday to Sunday", set all 3 time periods following the procedure described above.

b) Activation, deactivation of timer

- By pressing field no. **11**, you can activate the set timer mode.
- The heat pump heats the water in the ON periods (to the set temperature) and in the OFF periods, it does not heat the water.
- By pressing field no. **11** again, you can deactivate the set time mode of operation.

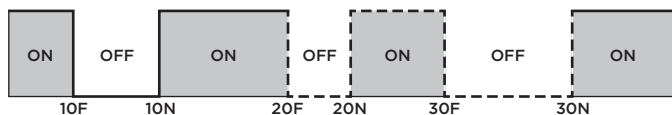

Figure 12: Time period

Fan settings

When the pressure drop is defined you select fan mode. It determines the fan speed.

Choose fan mode with the help of the **graph (Figure 4)**, displaying the aerodynamic characteristics of the fan in relation to the airflow and pressure drop in the air pipeline.

Noise

With the increase of the levels of the aerodynamic characteristics from the lowest to the highest, the noise also increases. Between 80% and 100% an increase of the noise level can be detected.

Maintenance levels

Figure 13 shows the structure of maintenance levels.

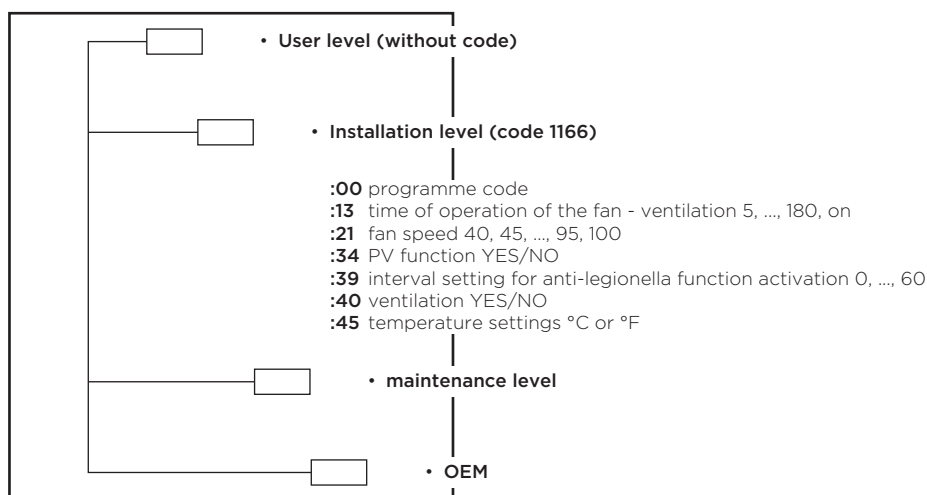

Figure 13: Maintenance levels structure

Maintenance level access

- By pressing field no. **4**, you can activate the maintenance mode (**Figure 10**).
- A display menu with an inscription “code” in the field **CLOCK** appears. Enter the maintenance code (fields FN1, FN2, FN3, FN4, FN5 in FN6 for numbers 1, 2, 3, 4, 5, 6).

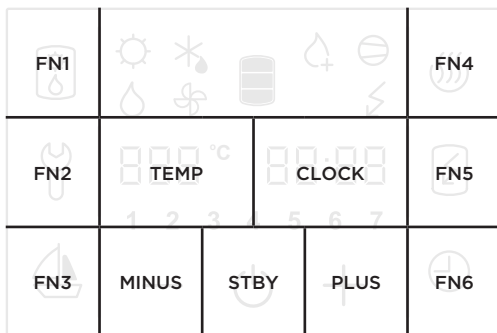

Figure 14: Fields display

- If you do not press any field for 10 s, the programme returns to the start menu.
- If the code is incorrect, the programme returns to previous operation.
- If the code is correct, the first parameter appears on the display. The number on the right is the serial number of the parameter and the field on the left is intended for its value.
- The first parameter **:00** is a version of a software code and serves information purposes only.
- By pressing the right number (Field **CLOCK** in **Figure 14**) you proceed to the next parameter.

Installation level (code 1166)

After the first code entry for the installation level the programme allows access to the following parameters:

- **:00** programme code
- **:13** time of operation of the fan - ventilation 5, ..., 180, on
- **:21** fan speed 40, 45, ..., 95, 100
- **:34** PV function YES/NO
- **:39** interval setting for anti-legionella function activation 0, ..., 60
- **:40** ventilation YES/NO
- **:45** temperature settings °C or °F

Setting the time of operation of the fan (parameter :13)

When the parameter (**:13**) is selected, press either (+) or (-) to set the desired time of operation of the fan (default: 30 minutes). Time up to 30 minutes can be set in 5 min steps, and above 30 minutes in 10 min steps. After the maximum time setting, ON appears, which means that the fan functions constantly until manually switched off. When the time of operation of the fan is set, the setting is stored automatically after a short time, or after pressing field no. **4**.

Fan speed settings (parameter: 21)

Select the parameter **:21** and set the fan speed by pressing (+) or (-) (40% - 100%). See the numerical value settings on the left side in field **5**. When the fan speed is set, you can save the changes by waiting a few moments or by pressing no. **4**.

PV function activation (photovoltaics) (parameter :34)

- Yes** - activated
- No** - deactivated

Anti-legionella function (parameter :39)

- Select the parameter (**:39**) and set the interval for the anti-legionella function activation (0 to 60 days) by pressing (+) or (-). See the numerical value settings on the left side in field **5**. When the interval of the anti-legionella function activation is set, the changes are saved automatically after a few moments, or manually by pressing field no. **4**. If the parameter (**:39**) is set to 0, the anti-legionella function is inactive.
- Factory settings of the anti-legionella function activation: Every 14 days of the heat pump operation, if the water temperature in the previous 2-week period did not exceed 65 °C continuously for at least an hour.
- The anti-legionella function works only when the heat pump is switched on. When activated, symbol no. **17** is displayed.
- The anti-legionella function can be activated manually by pressing field no. **15**.
- The anti-legionella function can be disabled by switching off the heat pump when pressing field no. **9**.

Warning: If heating when the anti-legionella function is activated, the boiler water temperature is 65 °C regardless of the temperature set on the appliance.

Fan activation (parameter :40)

Yes – activated

No – deactivated

Selecting temperature display (parameter: 45)

When parameter (:45) is selected, press either (+) or (-) to select the manner of temperature display in °C or °F (default value is °C). When the desired manner of display is selected, the setting is stored automatically after a short time, or after pressing field no. **4**.

Ventilation

- The feature can be activated by pressing field no. **2** shortly. The feature automatically switches off after the time set at parameter: 13 expires (default 30 minutes, see setting the time of operation of the fan, parameter :13).
- Symbol **2** is active and visible.
- By shortly pressing the field **2** again, the ventilation is deactivated.
- By shutting down the heat pump with the **on/off** options the ventilation is deactivated.
- In case of power failure during the functioning of the ventilation feature, once the power comes back the ventilation continues until the end of the set interval.
- In the event of any other failure the ventilation is deactivated.
- Ventilation cannot be activated:
 - in case of any kind of failure
 - during antilegionella function operation
 - during defrosting.

Backup mode (Models ZG and ZGNT)

- Activate backup mode by pressing field no. **2**.
- Symbol **3** is displayed.
- Backup mode uses heaters and is activated when an error occurs on the aggregate. The water is heated with heaters.
- By pressing field no. **2** backup mode is deactivated.
- If the backup mode is activated, please contact the maintenance services.

Operation signalization

Antilegionella programme:

- activated – control field **17** is displayed
- deactivated – control field **17** is not displayed

Electrical heater:

- activated – control field **14** is displayed
- deactivated – control field **14** is not displayed

Heat pump:

- activated – control field **16** is displayed
- deactivated – control field **16** is not displayed

On/off:

- activated – control field **9** and other fields are displayed
- deactivated – control field **9** is displayed

Defrosting:

- activated – control field **19** is displayed
- deactivated – control field **19** is not displayed

Fan on/off:

- activated – control field **20** is displayed
- deactivated – control field **20** is not displayed

Ventilation on/off (by pressing field no. **2**):

- activated – control field **2** is displayed

Backup mode on/off (by pressing field no. **2**):

- activated – control field **3** is displayed
- deactivated – control field **3** is not displayed

PV (PHOTOVOLTAICS)

- In case of voltage free contact between clamps 1 and 2 PV is activated (Figure 17).
- In case of voltage free contact between clamps 1 and 2 field 1 is displayed.
- The voltage free contact requires 800 W of electrical power.
- PV is deactivated in default settings.
- PV is activated in the installation menu with the activation of parameter 34.
- Set PV functions prior to time settings.
- PV mode does not affect the backup mode.
- The antilegionelle cycle is performed regardless the state of the PV mode.

PV operation (activated):

- PV is activated and the operation of the heat pump is allowed. The heat pump heats the water to the maximum temperature (see technical characteristics table). The heater is deactivated.
- No contact between PV clamps and the heat pump operation is allowed. The heat pump heats the water temperature up to 40°C.

Opening the EPP maintenance cover

Models TCX30XXXX

1. To remove a small part of the maintenance cover, pull on the bottom side.
 2. To remove the larger part of the maintenance cover, pull on the bottom side.
- Take reverse steps for closing the cover.

Models TCX20XXXX

Take step 2 of the TCX30XXXX models.

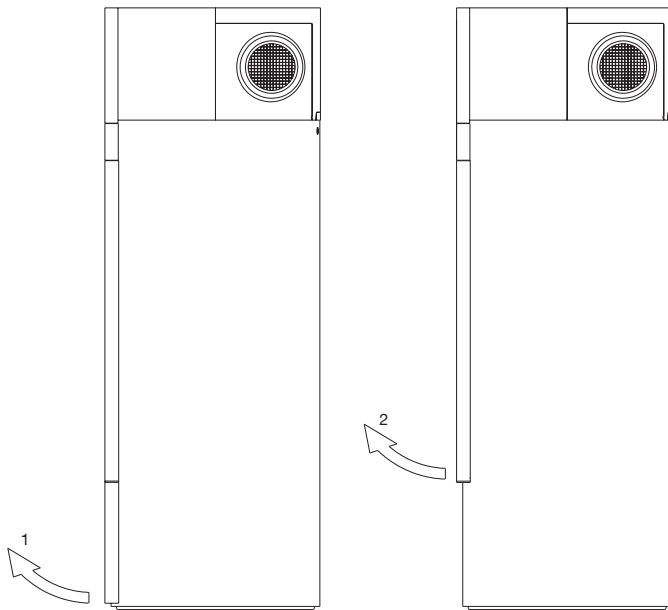

Figure 15: Opening the EPP maintenance cover

PV detection

The connection of the PV module to the heat pump must be performed by a qualified expert. On the back side of the heat pump, under the connection cord, there is a PV connection port. The PV port is shown in **figure 16**. Use a connection cord (minimum inner cross-section 0,5 mm², H05VV-F 2G 0,5 mm² and maximum external cross-section of 10 mm). The removal of the cover is described in the chapter above

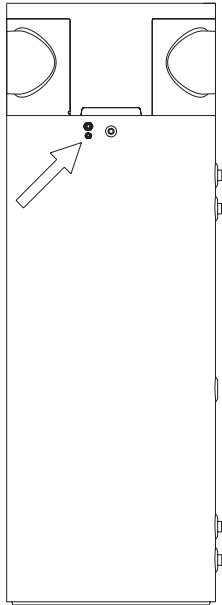

Figure 16: PV connection location

Connect the cord to the clamp, located under the control unit. The connection location is marked with PV. Use ports 1 and 2.

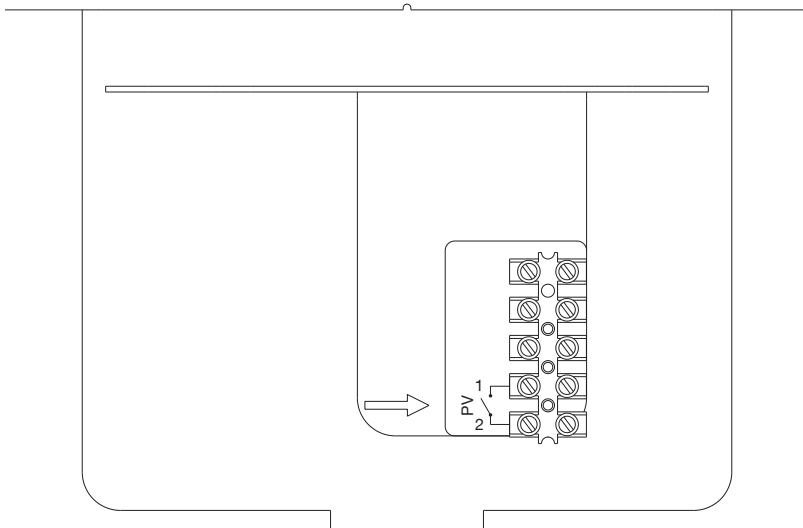

Figure 17: PV connection port

SERVICE AND MAINTENANCE

After the connection to the water supply mains and other heating sources the hot water tank with the heat pump is ready for use. If there is any possibility the water in the tank could freeze, you must drain the water from the tank. To do so, open the hot water lever at one of the mixing batteries, connected to the hot water tank. The water is drained via a drain valve on the inlet water pipe.

To clean the exterior of the heat pump, use a soft cloth and a mild detergent. Avoid cleaning agents containing alcohol and abrasive cleaners. If the heat pump was exposed to dust, evaporator lamellas might become blocked, which can have a detrimental effect on the functioning of the heat pump.

By providing regular service check-ups, you can ensure flawless operation and long life of the heat pump. The Warranty for the product is subject to the conditions of the Warranty statement.

Despite careful production and control, the heating pump can produce errors that must be solved by an authorised service provider.

Before calling your maintenance provider, check the following:

- Is everything OK with the power supply network?
- Is the air outlet obstructed (evaporator can freeze)?
- Is ambient temperature too low (evaporator can freeze)?
- Can you hear the operation of the compressor and fan?

 **Do not try to eliminate malfunctions by yourself, call your nearest authorized service provider!**

OPERATION ERRORS

Despite careful production and control, the heating pump can produce errors that must be solved by an authorised service provider.

Indicator of errors

- In case of an error on the appliance, the beeper starts beeping and field no. 4 starts flashing. When you press field no. **4** the error code is displayed in field no. **12**.

Error	Description of error	Solution
E004	• Freezing. The error appears if the temperature in the heat pump is below 4 °C.	• Call the service.
E005	• Overheating (temperature > 85 °C, electronic regulator failure).	• Unplug the heat pump from the power supply. Call the service.
E007	• Volume and/or temperature sensors error.	• Call the service.
E042	• Anti-legionella function error.	• Press field no. 4 to restart.
E247	• Defrosting error.	• Automatically turns on heating with the electric heater. When the error is deleted, the aggregate resumes its normal operation.
E361	• External air sensor error.	• Call the service (automatically switches to the electric heater).
E363	• Defrosting sensor error.	• Call the service (automatically switches to the electric heater).

WE RESERVE THE RIGHT TO ANY MODIFICATIONS NOT AFFECTING THE FUNCTIONALITY OF THE APPLIANCE.

The instructions for use are also available on our website <http://www.gorenje.com>.

