

GB

IE

MT

DETAILED INSTRUCTIONS

FOR USE OF A
COMBINED FREE
STANDING COOKER

gorenje

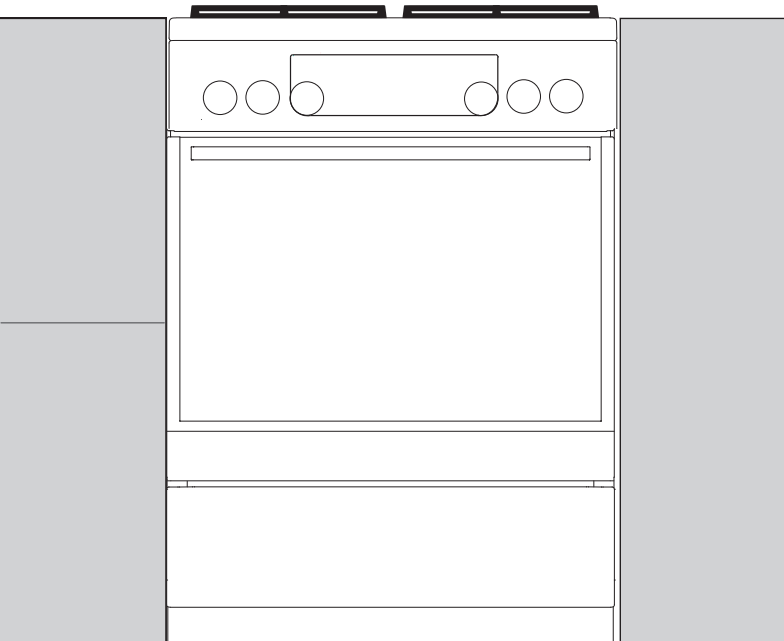
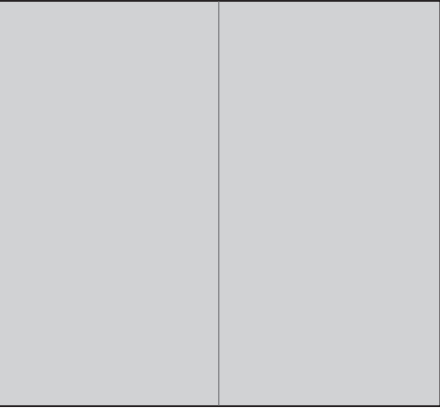

FK6A...
FM6A...

We thank you for your trust and the purchase of our appliance.

This detailed instruction manual is supplied to make the use of this product easier. The instructions should allow you to learn about your new appliance as quickly as possible.

Make sure you have received an undamaged appliance. If you do find transport damage, please contact the seller from which you purchased the appliance, or the regional warehouse from which it was supplied. The telephone number can be found on the invoice or on the delivery note.

Instructions for installation and connection are supplied on a separate sheet.

These instructions are only valid if the country symbol is printed on the appliance. If there is NO country symbol on the appliance, please consult the technical instructions for adjusting the appliance according to the requirements for use in the relevant country.

The appliance has to be connected in compliance with the effective regulations, and it may only be used in well ventilated areas. Read the instructions before connecting or using the appliance.

Instructions for use are also available at our website:

<http://www.gorenje.com>

GORENJE gospodinjski aparati, d.o.o.
Partizanska cesta 12
SI-3320 Velenje, SLOVENIJA
info@gorenje.com



Important information



Tip, note

CONTENTS

4 IMPORTANT SAFETY INSTRUCTIONS 8 Before connecting the appliance	INTRODUCTION
9 COMBINED FREE STANDING COOKER 13 Control unit 14 Appliance data - data plate	
15 USING THE APPLIANCE 15 Before using the appliance for the first time 15 Cooking hob (depending on the model) 18 Oven 21 Choosing the settings 23 Selecting additional functions/extras 25 Starting the cooking process 25 Switching off the oven 26 Descriptions of cooking systems and cooking table	USING THE APPLIANCE
42 MAINTENANCE & CLEANING 43 Conventional oven cleaning 43 Gas burner 44 Using the aqua clean function to clean the oven 45 Removing and cleaning wire and telescopic extendible guides 46 Cleaning and installing the catalytic inserts 47 Removing and inserting the oven door 50 Removing and inserting the oven door glass pane 52 Replacing the bulb	MAINTENANCE & CLEANING
53 SPECIAL WARNINGS AND FAULT REPORTING	TROUBLE-SHOOTING
55 INSTALLATION AND CONNECTION INSTRUCTIONS	INSTALLATION INSTRUCTIONS
61 NOZZLE TABLE	OTHER
63 DISPOSAL	

IMPORTANT SAFETY INSTRUCTIONS



CAREFULLY READ THE INSTRUCTIONS AND SAVE THEM FOR FUTURE REFERENCE

This appliance can be used by children aged from 8 years and above and persons with reduced physical, sensory or mental capabilities or lack of experience and knowledge if they have been given supervision or instruction concerning use of the appliance in a safe way and understand the hazards involved. Children shall not play with the appliance. Cleaning and user maintenance shall not be made by children without supervision.

WARNING: The appliance and its accessible parts become hot during use. Care should be taken to avoid touching heating elements. Children younger than 8 years of age shall be kept away unless continuously supervised.

WARNING: The accessible parts of the appliance may become hot during use. Young children should be kept away from the oven.

The appliance becomes very hot during use. Be careful not to touch the oven heaters.

WARNING: Danger of fire: do not store items on the cooking surfaces.

WARNING: Unattended cooking on a hob with fat or oil can be dangerous and may result in fire. NEVER try to extinguish a fire with water, but switch off the appliance and then cover flame e.g. with a lid or a fire proof blanket.

CAUTION: The cooking process has to be supervised.
A short term cooking process has to be supervised continuously.

WARNING: Before replacing the light bulb, make sure the appliance has been disconnected from the mains power, in order to prevent the hazard of an electric shock.

CAUTION: This appliance is for cooking purposes only. It must not be used for other purposes, for example room heating.

The appliance is not intended to be controlled by external timers or separate remote control system.

WARNING: Use only hob guards designed by the manufacturer of the cooking appliance or indicated by the manufacturer of the appliance in the instructions for use as suitable or hob guards incorporated in the appliance. The use of inappropriate guards can cause accidents.

WARNING: If the surface is cracked, switch off the appliance to avoid the possibility of electric shock.

CAUTION: In case of hotplate glass breakage:

- shut immediately off all burners and any electrical heating element and isolate the appliance from the power supply
- do not touch the appliance surface,
- do not use the appliance.

For appliance connection use a 5 x 1,5 mm² cord with mark H05VV-F5G1,5 or better. Cord must be installed by service agent or similar qualified person.

The appliance is intended to be placed directly on the floor, without any supports or plinths.

Metalic objects such as knives, forks, spoons and lids should not be placed on the hob surface since they can get hot..

Afte ruse, switch off the hob element by its control and do not rely on the pan detector.

Do not use harsh abrasive cleaners or sharp metal scrapers to clean the oven door glass or the glass of hinged lids of the hob (where appropriate), since they can scratch the surface, which may result in shattering of the glass.

The appliance must not be installed behind a decorative door in order to avoid overheating.

Cooker with stainless steel control panel and electrical oven is equipped with a cooling fan.

During operation of the oven, air flows from the cooker in the area under the control panel when door is closed.

If there is no air flow switch off the appliance and contact service.

Do not use steam cleaners or high-pressure cleaners to clean the cooking hob, as this may result in an electric shock.

If the supply cord is damaged, it must be replaced by the manufacturer, its service agent or similarly qualified persons in order to avoid a hazard.



- CAUTION: possibility of tilting.



- WARNING: In order to prevent tipping of the appliance, stabilising means must be installed. Refer to the instructions for installation.

Only use the temperature probe recommended for this oven.

Make sure the lid is clean and that there is no liquid spilt on it before raising it. The lid may be lacquer-coated or glass. It may only be closed when the cooking zones have completely cooled down.

Appliance must be connected to fixed wiring which is in accordance with the wiring rules.

Appliance must be connected to fixed wiring which has incorporated means of disconnection. Fixed wiring must be made in accordance with the wiring rules.

The appliance is intended for household use.

Do not use it for any other purpose, such as room heating, drying of pets or other animals, paper, fabrics, herbs etc. As this may lead to injury or fire hazard.

The appliance may only be connected by an expert authorized by the gas distribution company or an authorized service center. All relevant legislation and local gas distributor's technical conditions for connection to the gas mains should be complied with.

Unauthorized service and repair can result in risk of explosion, electric shock, or short circuit and consequently personal injury and damage to the appliance.

Such tasks may only be carried out by an authorized expert.

Before installing and connecting the appliance, make sure the local connection

conditions and characteristics (gas type and pressure) are compatible with the appliance set-up.

The set-up of the appliance is specified on the rating plate.

This appliance is not connected to a combustion products evacuation device.

It shall be installed and connected in accordance with current installation regulations. Particular attention shall be given to the relevant requirements regarding ventilation.

This is a class 2/1 appliance. The appliance may touch the adjacent cabinets on both sides when placed in a row. On one side, a tall cabinet - taller than the appliance - may be placed at a distance of at least 10 cm from the appliance. On the other side, only a cabinet of the same height may be placed.

Pay attention to correct placement of the burner parts..

Do not install the appliance near powerful sources of heat, such as solid fuel stoves, because high temperature near them can damage the appliance.

Close the main inlet valve if you do not intend to use the burners for a longer period of time (e.g. before going on vacation).

Oven door hinges may be damaged when under excessive load. Do not place heavy pans on open oven door and do not lean against open oven door when cleaning the oven cavity. Never stand on the open oven door and do not let children sit on it.

Appliance operation is safe with and without tray guides.

If the power cord is damaged, it should be replaced by the manufacturer or an authorized service technician, in order to avoid hazard.

If you observe any faults on the gas installation or smell gas in the room:

- immediately shut off the gas supply or close the gas cylinder;
- put out any open fire and extinguish any tobacco product;
- do not switch on any electrical appliances (including lights);
- thoroughly ventilate the room - open the windows;
- immediately inform the service centre or an authorized natural gas distributor.

Do not line the oven walls with aluminium foil and do not place baking trays or other cookware on the oven bottom. Aluminium foil would prevent air circulation in the oven, hinder the cooking process, and ruin the enamel coating.

Oven door become very hot during operation. A third glass is installed for extra protection, reducing the temperature of the outside surface (only with some models).

Oven door hinges may be damaged when under excessive load. Do not place heavy pans on open oven door and do not lean against open oven door when cleaning the oven cavity.

Never stand on the open oven door and do not let children sit on it.

Make sure the vents are never covered or obstructed in any other way.

CAUTION:The use of a gas cooking appliance results in the production of heat, moisture and products of combustion in the room in which it is installed. Ensure that the kitchen is well ventilated especially when the appliance is in use: keep natural ventilation holes open or install a mechanical ventilation device (mechanical extractor hood).

Prolonged intensive use of the appliance may call for additional ventilation, for example opening of a window, or more effective ventilation, for example increasing the level of mechanical ventilation where present.

The appliance is heavy. For carrying the appliance at least 2 persons are needed.

BEFORE CONNECTING THE APPLIANCE



Carefully read the instructions for use before connecting the appliance. Repair or any warranty claim resulting from incorrect connection or use of the appliance shall not be covered by the warranty.

COMBINED FREE STANDING COOKER

DESCRIPTION OF THE OVEN AND EQUIPMENT

(depending on the model)

Since the appliances for which these instructions were drawn up may have different equipment, some functions or equipment may be described in the manual that may not be present in your appliances.

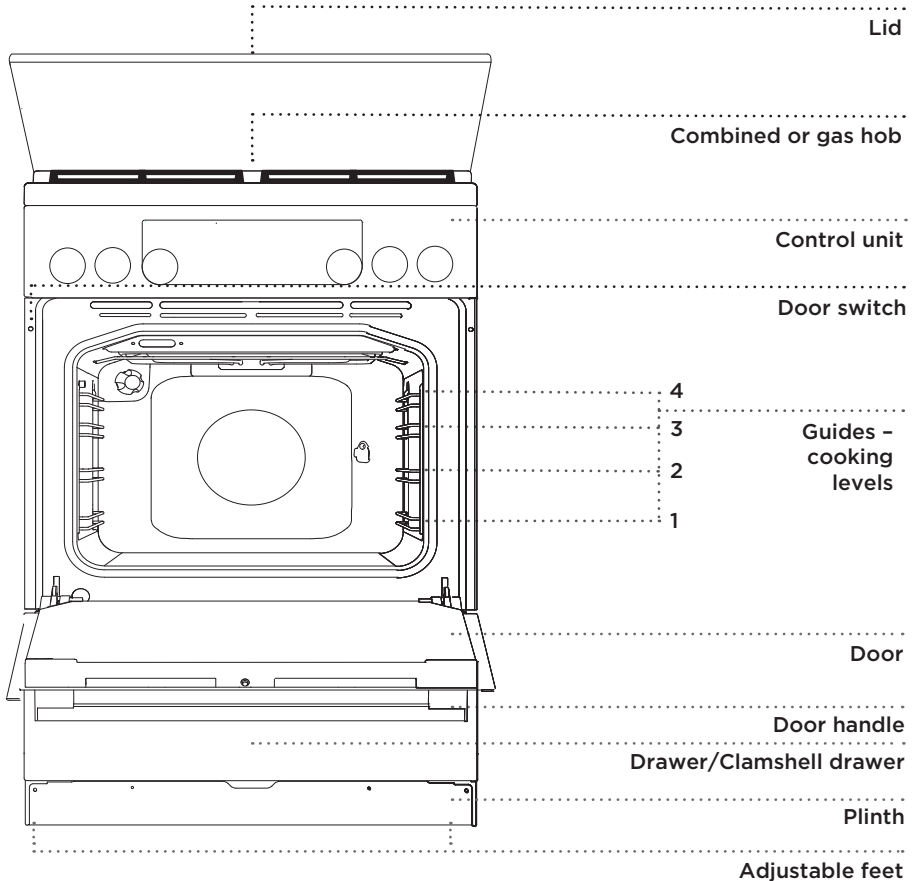

APPLIANCE LID

Make sure the lid is clean and that there is no liquid spilt on it before raising it. The lid may be lacquer-coated or glass. It may only be closed when the cooking zones have completely cooled down.



The symbol on the product or its packaging indicates that glass lids may shatter when heated. Turn off all the burners before shutting the lid.

APPLIANCE DRAWER



Do not store combustible, explosive, volatile or temperature-sensitive items (such as paper, dish cloths, plastic bags, cleaners or detergents and spray cans) in the oven's storage drawer, as they can ignite during excessive operation and cause a fire.

CONTROL LIGHT

When the oven is switched on, **the yellow signal light** is on.

The yellow light is on whenever any appliance function is activated (depending on the model).

When a function is selected, the dial of the selected knob will be lit up.

Oven lighting will be switched on automatically when the cooking system is selected.

WIRE GUIDES

The wire guides allow preparation of the food on four levels.

TELESCOPIC PULL-OUT GUIDES

Telescopic pull-out guides may be fitted for the 2nd, 3rd, and 4th level.

Pull-out guides can be partly or fully extendible.

EMBOSSSED GUIDES

The oven has stamped side grooves in three levels for inserting of the grid.

OVEN DOOR SWITCH

The switch deactivates oven heating and the fan when the oven door is opened during the cooking process. When the door is closed, the switch turns the heaters back on.

COOLING FAN

The appliance is fitted with a cooling fan that cools the housing, door and the appliance control panel.

After the oven is switched off, the cooling fan continues to operate for a short while in order to cool the oven.

OVEN EQUIPMENT AND ACCESSORIES (depending on the model)

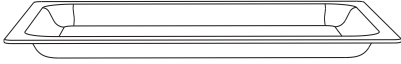

GLASS BAKING DISH is used for cooking with all oven tray systems. It can also be used as a serving tray.



The **GRID** is used for grilling or as support for a pan, baking tray or baking dish with the food.



There is a safety latch on the grid. Therefore, lift the grid slightly at the front when pulling it out from the oven.

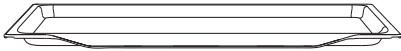

Use the **BAKING TRAY** for cooking of all types of meat, fish and vegetables, as well as for catching the drippings when cooking on the wire rack.

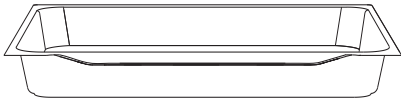

The **DEEP BAKING TRAY** is used for roasting meat and baking moist pastry. It can also be used as a drip tray.



Never place the deep baking tray in the first guide during the cooking process, except when grilling food or using the roasting spit and you are only using the deep tray as a drip tray.



As baking accessories heat up, their form may change. This does not affect their functionality and their original form will be restored when they cool down.

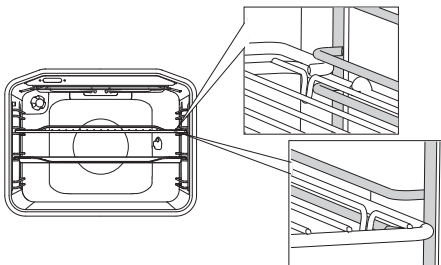

The grid or the tray should always be inserted into the groove between the two wire profiles.

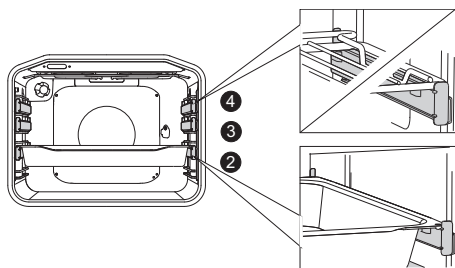

With telescopic extendible guides, first pull out the guides of one level and place the grid or the baking tray onto them. Then, push them in with your hand as far as they will go.

 Close the oven door when the telescopic guides are retracted all the way into the oven.

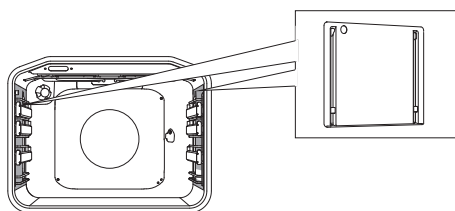

CATALYTIC INSERTS prevent the fat from sticking to sides of the oven cavity.



The **TURNSPIT** (meat skewer) is used for roasting meat. The set consists of a skewer support, skewer with screws, and a removable handle. (depending on the model)



The appliance and some of the accessible parts tend to heat up during cooking. Use oven mitts.

CONTROL UNIT

(depending on the model)

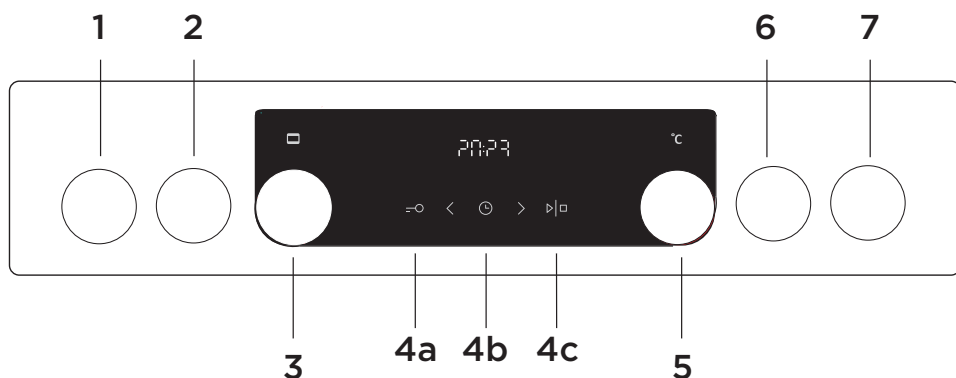

- 1 COOKING ZONE KNOB, FRONT LEFT
- 2 COOKING ZONE KNOB, REAR LEFT
- 3 COOKING SYSTEM SELECTOR KNOB
- 4a CHILD LOCK KEY
- 4b CLOCK AND TIMER SELECTION KNOB
- 4c START/STOP KEY
- 5 TEMPERATURE KNOB
- 6 COOKING ZONE KNOB, REAR RIGHT
- 7 COOKING ZONE KNOB, FRONT RIGHT

NOTE:

Symbols of cooking systems may be located on the knob or on the front panel (depending on the appliance model).

The keys will respond better if you touch them with a larger area of your fingertip. Each time you press a key, a short acoustic signal will be sounded.

APPLIANCE DATA - DATA PLATE

(depending on the model)

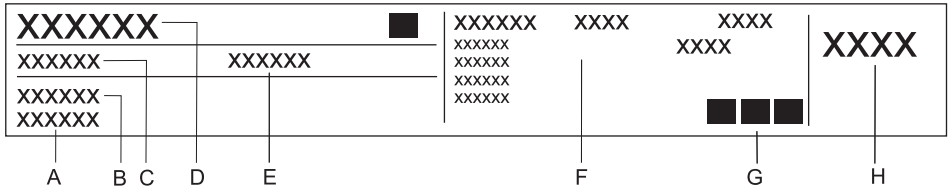

- A Serial number
- B Model
- C Type
- D Trademark
- E Code
- F Technical information
- G Compliance indications / symbols
- H Factory settings for gas type

The rating plate, indicating the basic information about the appliance, is located on the edge of the oven and it is visible when the oven door is opened.

Electrical parameters (depends on type; see appliance data plate):

220-240V~ ; 50-60Hz; 1x16A

380-415V 2N~ ; 50-60Hz; 2x16A

Degree of protection: IPX0

Country of destination	Appliance Categories
GB	I2H, I3+, II2H3+, II2H3P
IE	I2H, I3+, II2H3+, II2H3P
MT	I3B/P

HEAT INPUT

Type designation	Total nominal gas heat input (kW)	Total nominal electric input (kW)
FM6Axx-xxxxx	8,3	3,3
	7,8	3,3
FK6Axx-xxxxx	6,4	5,3
	5,9	5,3
	5,4	6,3
	4,9	6,3

USING THE APPLIANCE

BEFORE USING THE APPLIANCE FOR THE FIRST TIME

Upon receiving the appliance, remove all parts, including any transport equipment, from the oven.

Clean all accessories and utensils with warm water and regular detergent. Do not use any abrasive cleaners.

When the oven heats up for the first time, the characteristic smell of a new appliance will be emitted. Ventilate the room thoroughly during the first operation.

If your **cooking hob** has conventional cooking zones, switch them on to the maximum power for 3 to 5 minutes without any cookware on them. As the cooking zones heat up, some smoke may appear on the cooking hob surface. Thus, the cooking zone finish reaches its maximum resistance.

COOKING HOB (depending on the model)

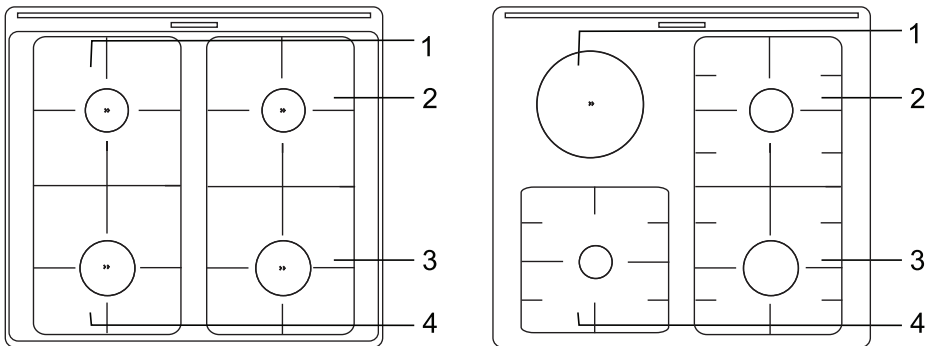

1. Cooking zone rear left
2. Cooking zone rear right
3. Cooking zone front right
4. Cooking zone front left

GAS BURNERS

- To sear the food, set the burner to maximum power first, and then continue to cook at minimum power.
- Always place the burner cap accurately on the burner crown. Make sure the slots in the burner crown are never blocked.

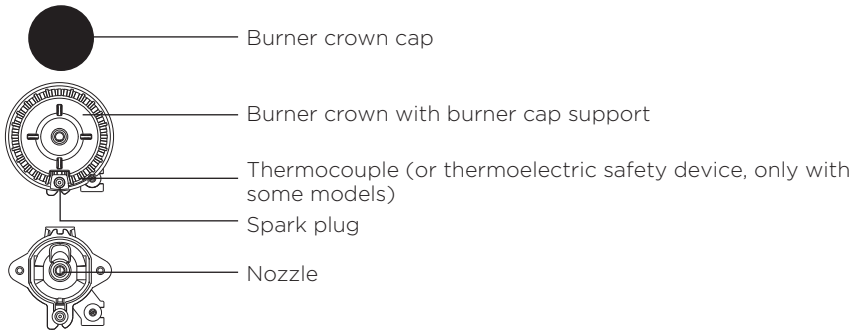

TIPS REGARDING YOUR COOKWARE

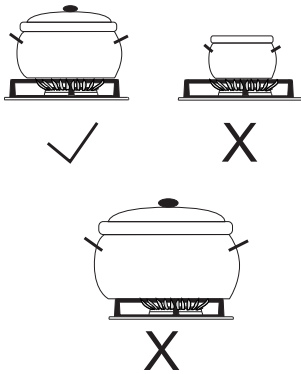

- Correct choice of cookware allows optimum cooking time and gas consumption. Cookware diameter is the most important in this respect.
- If a pot or a pan is too small, the flames reaching over the edge of its bottom will damage it. Moreover, gas consumption will be higher.
- Combustion of gas also requires air. If the pot or pan is too large, there is not enough air and the burning efficiency is decreased.



Gas hob reducer (only with some models) Use the gas hob reducer when cooking in a container of smaller diameter. Place it on the grid over the auxiliary burner.



Burner type	Container diameter
Large (3.0 kW)	220-260 mm
Normal (1.9 kW)	160-220 mm
Auxiliary (1.9 kW)	120-140 mm
Multi-ring burner (3.5 kW)	220-260 mm

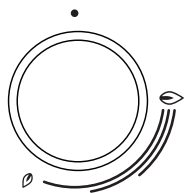

BURNER IGNITION AND OPERATION (depending on the model)

 Always press the knob before rotating it.



Cooking power levels are indicated on the knobs with a large and a small flame symbol. Rotate the knob over **the large flame** position  to **the small flame** position  and back. Operating range is between the two flame symbols.

Settings between  and  are not recommended. In this range, the flame is unstable and may be extinguished.

 Place the pot or pan on the grid above the burner before igniting it (applies to three-ring, double-ring, and mini-wok burner). To turn off a burner, rotate the knob to the right to position .

Single-handed ignition



To ignite a gas burner, press the corresponding knob and rotate it to the maximum power position. Electric spark from the spark plug will be activated and the gas will ignite.

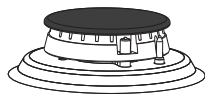

Two-handed ignition

To ignite a gas burner, press the corresponding knob and rotate it to the maximum power position. **Press the spark plug button.** Electric spark from the spark plug will be activated and the gas will ignite.



 Electric ignition will only work if the power cord is connected to the mains power. If electric ignition does not work due to a power supply failure or damp spark plugs, the gas can still be ignited with a match or a lighter. After ignition, keep the knob depressed for approximately 10 more seconds until the flame is stabilized.



If the burner does not ignite in 15 seconds, close it and wait for at least 1 minute. Then repeat the ignition process.

If the flame on a burner is extinguished (regardless of the reason), close the burner and wait for 1 minute before trying to ignite it again.

OVEN

SWITCHING ON AND SETTINGS

After connecting your appliance or after an extended power outage, 12:00 will flash on the display and the symbol will light up .

Set the time of day.

SETTING THE CLOCK

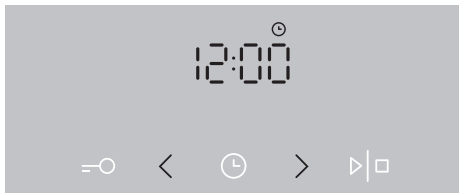

1 Set the clock by touching the < or > keys, and confirm the setting by touching the  key.

 If you press and hold the value adjustment key, the rate at which the set value is being changed will increase.

CHANGING THE CLOCK SETTING

Clock settings may be changed when no timer function is activated. To set the current time (clock), touch the CLOCK key several times to select the  symbol.

CHOOSING THE COOKING SYSTEM (depending on the model)

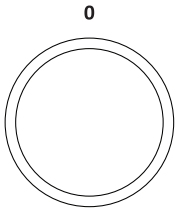









Rotate the knob (left and right) to select the cooking system (see program table, depending on the model).



Settings can also be changed during the cooking process.

SYSTEM	DESCRIPTION	SUGGESTED TEMPERATURE °C
COOKING SYSTEMS		
»»»»	RAPID PREHEAT Use this function if you wish to heat the oven to the desired temperature as quickly as possible. This function is not appropriate for cooking food. When the oven heats up to the desired temperature, the heating process is completed.	160
— —	UPPER AND BOTTOM HEATER The heaters in the bottom and in the ceiling of the oven cavity will radiate heat evenly into the oven interior. Pastry or meat can only be baked/roasted at a single height level.	200
— —	TOP HEATER Only the heater on the oven cavity ceiling will radiate heat onto the food. Use it to brown the upper side of your dish (final browning).	180
— —	BOTTOM HEATER Only the heater on the bottom of the oven cavity will radiate heat. Use this heater to brown the lower side of the dish.	180
▼▼	GRILL Only grill heater, a part of the large grill set, will operate. This system is used for grilling a smaller amount of open sandwiches or beer sausages, and for toasting bread. Maximal allowed temperature: 230°C.	220
▼▼▼	LARGE GRILL The upper heater and the grill heater will operate. The heat is radiated directly by the grill heater installed in the oven ceiling. To boost the heating effect, the upper heater is activated as well. This combination is used for grilling a smaller amount of open sandwiches, meat or beer sausages, and for toasting bread. Maximal allowed temperature: 230°C.	220
▼▼▼ ✻	GRILL WITH FAN Grill heater and the fan will operate. This combination is used to grill meat and to roast larger chunks of meat or poultry at a single height level. It is also appropriate for dishes au gratin and for browning to a crispy crust.	170



SYSTEM	DESCRIPTION	SUGGESTED TEMPERATURE °C
	TOP HEATER AND FAN The top (upper) heater and the fan will operate. Use this system to roast larger chunks of meat and poultry. It is also suitable for dishes au gratin.	170
	HOT AIR AND BOTTOM HEATER The bottom heater, the round heater, and the hot air fan will operate. This is used to bake pizza, moist pastry, fruitcakes, leavened dough and shortcrust.	200
	HOT AIR Round heater and the fan will operate. The fan installed in the back wall of the oven cavity makes sure the hot air constantly circulates around the roast or pastry. This mode is used for roasting meat and baking pastry.	180
	BOTTOM HEATER AND FAN This is used for baking leavened but low-rising pastry and for preserving fruit and vegetables.	180
	TOP AND BOTTOM HEATER WITH FAN Both heaters and the fan are activated. The fan allows even circulation of hot air inside the oven. It is used for baking pastry, for defrosting, and for drying fruit and vegetables.	180
	PLATE WARMER Use this function to reheat your dinnerware (plates, cups) before serving food in it to keep the food warm longer.	60
	GENTLEBAKE ¹⁾ This feature allows gentle, slow, and even baking that leaves the food soft and juicy. It is suitable for roasting meat, cooking fish, and baking pastry on a single rack. Set the temperature in the range from 140 to 220 °C.	180
	DEFROSTING The air circulates with no heaters activated. Only the fan will be activated. This is used to slowly thaw frozen food.	-
	AQUA CLEAN Only the bottom heater will radiate heat. Use this function to remove stains and food residues from the oven. The program takes 30 minutes.	70

¹⁾ It is used for determining the energy efficiency class pursuant to the EN 60350-1 standard.

CHOOSING THE SETTINGS

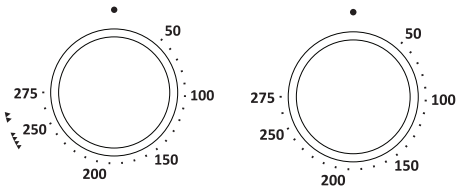
ADJUSTING THE COOKING TEMPERATURE



 When using the oven system with the large grill and grill, set the temperature knob to position .



Rotate the knob to set the desired TEMPERATURE.

After switching on the appliance by touching the START key, the temperature icon is displayed on the display unit.

 To switch on the appliance, press the START key and hold it for a while - about 1 second.

TIMER FUNCTIONS

First rotate the COOKING SYSTEM SELECTOR KNOB; then, set the temperature.

Touch the TIMER key several times to select the desired timer function. The icon for the selected timer function will light up and the adjustable cooking start/end time will flash on the display.

Press START to start the cooking process. ELAPSED COOKING TIME will be displayed.

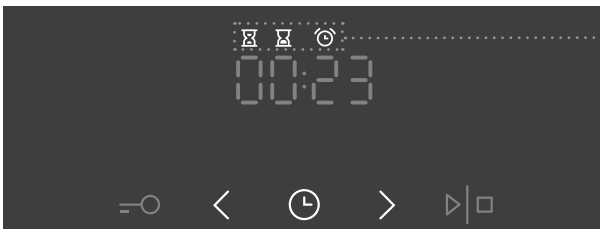

Timer function display



Setting the cooking time

In this mode, you can define the duration of oven operation (cooking time). Set the desired cooking time. First set the minutes, then the hours. Icon and cooking time are displayed on the display unit.



Setting the delayed start

In this mode, you may specify the duration of the cooking process (cooking time) and the time when you wish the cooking process to stop (end time). Make sure the clock is accurately set to current time.

Example:

Current time: noon

Cooking time: 2 hours

End of cooking: 6 pm

First set the OPERATION DURATION (2 hours). Touch the CLOCK button twice to select the END OF OPERATION. The display automatically shows a flashing sum of the time of day and duration of operation of the oven (14:00).

Set the time for the end of baking (18:00)

Press START to start the cooking process. The timer will wait for the time to start the cooking process and the symbol will be lit up. The oven automatically switches on (at 4 pm) and stops operating and the selected time (at 6 pm).



Setting the minute minder

The minute minder can be used independently of the oven operation. The longest possible setting is 24 hours.

During the last minute, the minute minder is displayed in seconds.



After the set time expires, the oven will automatically stop operating (end of cooking). An acoustic signal will be heard which you may turn off by touching any key. After one minute, the acoustic signal will be switched off automatically.

Timer functions can be cancelled by setting the time to "0". Any timer function may also be quickly cancelled by simultaneously pressing the < and > key and holding them for a while.

SELECTING ADDITIONAL FUNCTIONS/ EXTRAS

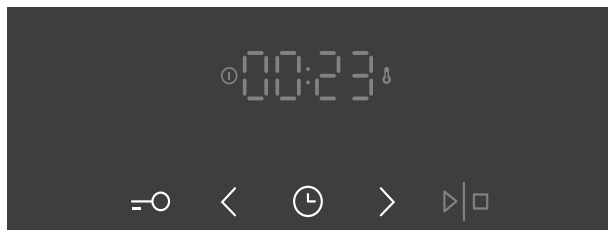

Activate/deactivate the functions by pressing the desired key or a combination of keys.

CHILD LOCK

Activate it by touching the CHILD LOCK key. "Loc" will appear on the display unit for 5 seconds. Touch the key again to deactivate the child lock.

If the child lock is activated with no timer function engaged (only clock is displayed), then the oven will not operate. If the child lock is activated after a timer function has been set, then the oven will operate normally; however, it will not be possible to change the settings.

When the child lock is activated, the systems can be changed, but it is not possible to change the extra functions. The cooking process can be ended by rotating the selector knob to "0". Child lock will remain active after the oven is switched off. To select a new system, the child lock must first be deactivated.

OVEN LIGHTING

Oven lighting will be switched on automatically each time a cooking system is selected.

5sek < ACOUSTIC SIGNAL

Loudness of the acoustic signal can be set when no timer function is activated (only the time of day is displayed).

Press the < key and hold it for five seconds. First, "Vol" will appear on the display unit, followed by two fully lit bars. Touch the < and > keys to choose one of the three volume levels (one, two, or three bars). After three seconds, the setting will be automatically stored and the time of day will appear.

5sek > DECREASING THE DISPLAY CONTRAST

The cooking system selector knob has to be in position "0".

Hold the > key for 5 seconds. First, "bri" will appear on the display unit, followed by two fully lit bars. Touch the < and > keys to adjust the display dimmer (one, two, or three bars). After three seconds, the setting will be automatically saved.

SWITCHING ON/OFF THE CLOCK DISPLAY

To switch off the clock display, simultaneously touch the "key" and "clock" keys and hold them for 5 seconds. "OFF" will appear for a few seconds; then, the  icon will light up.

To reactivate the clock display, simultaneously press the "key" and "clock" keys again while no timer function is active.



After a power outage or after the appliance is switched off, the additional function settings will remain stored for no more than a few minutes. Then, all settings, except for the acoustic signal, display dimmer, and child lock will be reset to factory defaults.

STARTING THE COOKING PROCESS

Start the cooking process by pressing the START/STOP key and holding it for a while. Temperature and operation symbols will be lit up.

If no timer function is selected, the cooking duration time, cooking time will appear on the display unit.



While the oven is heating up, the temperature symbol will flash. When the oven reaches the set temperature, the symbol will light up and a short beep will be sounded.

 Simbol za temperaturo se med delovanjem prižiga in ugaša, saj prikazuje delovanje grelcev.

SWITCHING OFF THE OVEN

To stop the cooking process, press and hold the START/STOP key.

Turn the COOKING SYSTEM SELECTOR and TEMPERATURE KNOB to position "0".

 After the cooking process, all timer settings are also paused and cancelled, except for the minute minder. Time of day (clock) will be displayed. The cooling fan will continue to operate for a while.

DESCRIPTIONS OF COOKING SYSTEMS AND COOKING TABLE

If your desired food cannot be found in the cooking table, find information for similar food. The information displayed applies to cooking on a single level.

An interval of suggested temperature is indicated. Start with a lower temperature setting and increase it if you find the food is not browned sufficiently.

Only preheat the oven if required by the recipe in the tables in this instruction manual. Heating an empty oven consumes a lot of energy. Hence, baking several types of pastry or several pizzas successively will save a lot of energy, as the oven will already be preheated.

Use dark, black silicon-layered or enamel-coated baking sheets and trays as they conduct the heat very well.

When using parchment paper, make sure it is resistant to high temperatures.

When cooking larger chunks of meat or pastry, a lot of steam will be generated inside the oven, which in turn may condense on the oven door. This is a normal phenomenon which will not affect the operation of the appliance. After the cooking process, wipe the door and the door glass dry.

Switch off the oven approximately 10 minutes before the end of the cooking process to save energy by making use of the accumulated heat.

Do not cool the food in a closed oven to prevent condensation (dew).

Standard doneness levels and recommended final core temperature for different types of meat

Type of food	Food core temperature (°C)	Meat colour on cross-section, and colour of juices
BEEF		
Rare	40-45	meaty red, like raw meat, little juice
Medium rare	55-60	light red, a lot of light red juice
Medium	65-70	pink, small amount of pale pink juice
Well done	75-80	evenly greyish brown, little colourless juice
VEAL		
Well done	75-85	red-brown
PORK		
Medium	65-70	light pink
Well done	75-85	yellow-brown
LAMB		
Well done	79	grey, pinkish juice
MUTTON		
Rare	45	meaty red
Medium rare	55-60	light red
Medium	65-70	pink in the middle
Well done	80	grey
GOAT MEAT		
Medium	70	pale pink, pink juices
Well done	82	grey, juices only slightly pink
POULTRY		
Well done	82	light grey
FISH		
Well done	65-70	white to grey-brown

UPPER AND BOTTOM HEATER

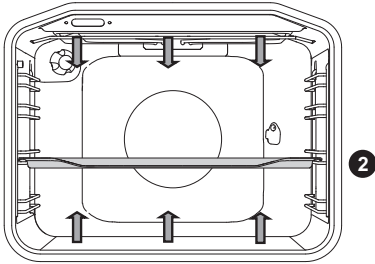

The heaters in the bottom and in the ceiling of the oven cavity will radiate heat evenly into the oven interior.

Roasting meat:

Use enamel coated, tempered glass, clay, or cast iron pan or tray. Stainless steel trays are not suitable as they strongly reflect the heat.

Use enamel coated, tempered glass, clay, or cast iron pan or tray. Stainless steel trays are not suitable as they strongly reflect the heat.

Type of food	Weight (g)	Guide (from the bottom)	Temperature (°C)	Cooking time (minutes)
MEAT				
Pork roast	1500	2	180-200	90-110
Pork shoulder	1500	2	180-200	100-120
Pork roulade	1500	2	180-200	120-140
Meat loaf	1500	2	200-210	60-70
Beef roast	1500	2	170-190	120-140
Veal roulade	1500	2	180-200	90-120
Lamb sirloin	1500	2	180-200	80-100
Rabbit loin	1500	2	180-200	50-70
Deer shank	1500	2	180-200	100-120
Pizza*	/	2	200-220	20-30
Chicken	1500	2	190-210	70-90
FISH				
Braised fish	1000	2	210	50-60

Use this system to roast chicken, if the appliance does not have the system.

Use this system to bake pizza, if the appliance does not have the system.

The symbol * means that the oven should be preheated using the selected cooking system.

Baking pastry:

Only use one level and dark baking sheets or trays. In light-coloured baking sheets or trays, the browning of the pastry will be poorer, as such equipment will reflect the heat. Always place the baking trays on the grid. If you are using the supplied baking sheet, remove the grid. Cooking time will be shorter if the oven is preheated.

Type of food	Guide (from the bottom)	Temperature (°C)	Cooking time (minutes)
PASTRY			
Vegetable soufflé	2	190-200	30-35
Sweet soufflé	2	190-200	30-35
Rolls*	2	190-210	20-30
White bread*	2	180-190	50-60
Buckwheat bread*	2	180-190	50-60
Whole grain bread*	2	180-190	50-60
Rye bread*	2	180-190	50-60
Spelt bread*	2	180-190	50-60
Walnut cake	2	170-180	50-60
Sponge cake*	2	160-170	25-30
Cheesecake	2	170-180	65-75
Cupcakes	2	170-180	25-30
Small pastries made with yeast dough	2	200-210	20-30
Cabbage pirozhki	2	185-195	25-35
Fruitcake	2	150-160	40-50
Meringue cookies	2	80-90	120-130
Jelly-filled rolls (Buchtel)	2	170-180	30-40

The symbol * means that the oven should be preheated using the selected cooking system.



Do not insert the deep baking tray into the first guide.

LARGE GRILL, GRILL

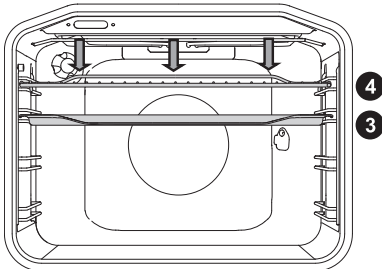

When grilling food with the large grill, the upper heater and the grill heater fitted on the ceiling of the oven cavity will operate.

When grilling food, the upper heater and the grill heater fitted on the ceiling of the oven cavity will operate.

Max allowed temperature : 230°C

Preheat the infrared (grill) heater for five minutes.

Supervise the cooking process at all times. The meat may burn quickly due to high temperature.

Roasting with the grill heater is suitable for crispy and low-fat cooking of bratwurst, cuts of meat and fish (steaks, escalopes, salmon steaks or fillets etc.) or toasted bread.

When grilling directly on the grid, smear it with oil to prevent the meat from sticking onto it and insert it into the 4th guide. Insert the drip tray in to the 1st or 2nd guide. When grilling in a baking tray, make sure there is enough liquid in the tray to prevent burning. Turn the meat during cooking.

After grilling, clean the oven, the accessories, and the utensils.

Grilling table - small grill

Type of food	Weight (g)	Guide (from the bottom)	Temperature (°C)	Cooking time (minutes)
MEAT				
Beefsteak, rare	180 g/piece	3	230	15-20
Pork neck fillet	150 g/piece	3	230	18-22
Cutlets/chops	280 g/piece	3	230	20-25
Grill sausages	70 g/piece	3	230	10-15
TOASTED BREAD				
Toast	/	4	230	3-6
Open sandwiches	/	4	230	3-6

Grilling table - large grill

Type of food	Weight (g)	Guide (from the bottom)	Temperature (°C)	Cooking time (minutes)
MEAT				
Beefsteak, rare	180 g/piece	3	230	15-20
Beefsteak, well done	180 g/piece	3	230	18-25
Pork neck fillet	150 g/piece	3	230	20-25
Cutlets/chops	280 g/piece	3	230	20-25
Veal escalope	140 g/piece	3	230	20-25
Grill sausages	70 g/piece	3	230	10-15
Spam (Leberkäse)	150 g/piece	3	230	10-15
FISH				
Salmon steaks/fillets	200 g/piece	3	230	15-25
TOASTED BREAD				
Toast	/	4	230	1-3
Open sandwiches	/	4	230	2-5

When grilling in a baking tray, make sure there is enough liquid in the tray to prevent burning. Turn the meat during cooking.

When baking trout, pat the fish dry with a paper towel. Season on the inside; coat with oil on the outside and place on the grid. Do not turn the fish when grilling.



Always keep the oven door closed when using the grill (infrared) heater.

Grill heater, grid, and other oven accessories get very hot during grilling. Therefore, use oven mitts and meat tongs.

Cooking with the turnspit (depending on the model)



Maximum temperature when using the rotisserie is 230°C.

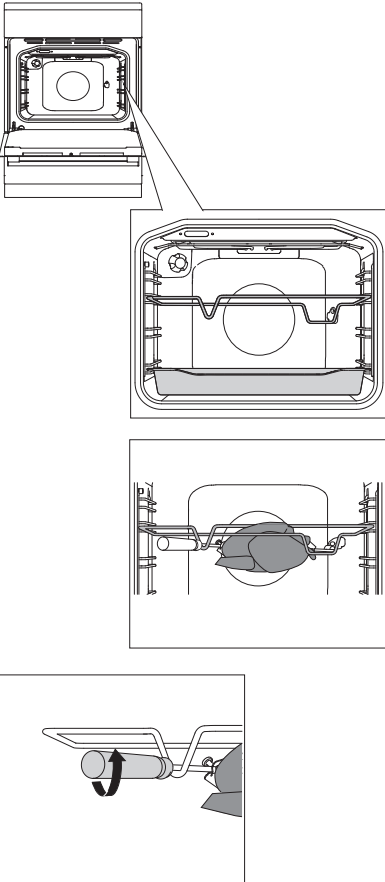

1 Insert the skewer support into the 3rd guide from the bottom and place the deep tray into the bottom (1st) guide to serve as a drip tray.

2 Impale the meat on the skewer and tighten the screws.

Place the skewer handle on the front skewer support and insert the tip into the opening in the right hand side of the rear oven cavity wall (the opening is protected with a rotating cover).

3 Undo the skewer handle and close the oven door.

Switch on the oven and select the LARGE GRILL system



The grill will only operate when the oven door is closed.

GRILL WITH FAN

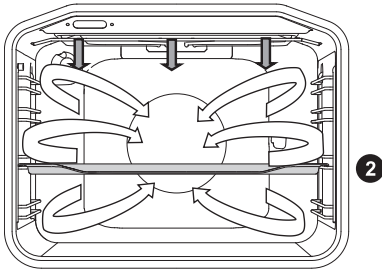

In this operating mode, the grill heater and the fan operate simultaneously. Suitable for grilling meat, fish, and vegetables.

(See descriptions and tips for GRILL).

Type of food	Weight (g)	Guide level (from the bottom)	Temperature (°C)	Cooking time (min)
MEAT				
Duck	2000	2	150-170	80-100
Pork roast	1500	2	160-170	60-85
Pork shoulder	1500	2	150-160	120-160
Pork shank	1000	2	150-160	120-140
Half of chicken	700	2	190-210	50-60
Chicken	1500	2	190-210	60-90
FISH				
Trout	200 g/piece	2	200-220	20-30



HOT AIR AND BOTTOM HEATER

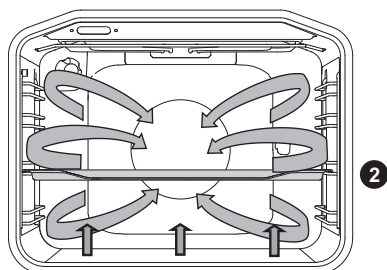

The bottom heater, the round heater, and the hot air fan will operate. Suitable for baking pizzas, apple pies, and fruitcakes.

(See descriptions and tips for UPPER and BOTTOM HEATER).

Type of food	Guide (from the bottom)	Temperature (°C)	Cooking time (minutes)
Cheesecake, short crust	2	150-160	65-80
Pizza *	2	200-210	15-20
Quiche Lorraine, shortcrust	2	180-200	35-40
Apple pie, leavened dough	2	150-160	35-40
Apple strudel, phyllo dough	2	170-180	45-65

The symbol * means that the oven should be preheated using the selected cooking system.

HOT AIR

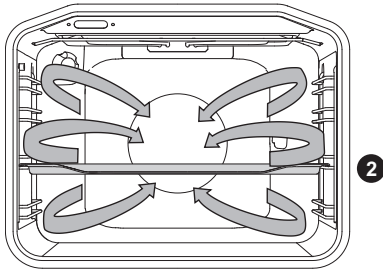

Round heater and the fan will operate. The fan installed in the back wall of the oven cavity makes sure the hot air constantly circulates around the roast or pastry.

Roasting meat:

Use enamel coated, tempered glass, clay, or cast iron pan or tray. Stainless steel trays are not suitable as they strongly reflect the heat.

Provide enough liquid during the cooking process to prevent the meat from burning. Turn the meat during roasting. The roast will remain juicier if you cover it.

Type of food	Weight (g)	Guide (from the bottom)	Temperature (°C)	Cooking time (minutes)
MEAT				
Pork roast, including skin	1500	2	170-180	140-160
Duck	2000	2	160-170	120-150
Goose	4000	2	150-160	180-200
Turkey	5000	2	150-170	180-220
Chicken breast	1000	3	180-200	60-70
Stuffed chicken	1500	2	170-180	90-110

Baking pastry:

Preheating is recommended.

Biscuits and cookies can be baked in shallow baking sheets on several levels simultaneously (2nd and 3rd).

Note that baking time can differ even with if the baking sheets used are the same. The biscuits in the upper baking sheet may be ready sooner than those in the lower one.

Always place the baking trays on the grid. If you are using the supplied baking sheet, remove the grid.

For even browning, make sure the biscuits are of the same thickness.

Type of food	Guide (from the bottom)	Temperature (°C)	Cooking time (minutes)
PASTRY			
Sponge cake	2	150-160	25-35
Crumble cake	2	160-170	25-35
Fruit cake, sponge	2	150-160	45-65
Sponge roll*	2	160-170	15-25
Fruit cake, short crust	2	160-170	50-70
Apple strudel	2	170-180	40-60
Biscuits, short crust*	2	150-160	15-25
Biscuits, pressed*	2	140-150	15-25
Cookies, leavened	2	170-180	20-35
Cookies, phyllo dough	2	170-180	20-30
PASTRY - FROZEN			
Apple and cottage cheese strudel	2	170-180	50-70
Pizza	2	170-180	20-30
Fried potatoes, oven-ready	2	170-180	20-35
Croquettes, oven-baked	2	170-180	20-35

The symbol * means that the oven should be preheated using the selected cooking system.



Do not insert the deep baking tray into the first guide.

BOTTOM HEATER AND FAN

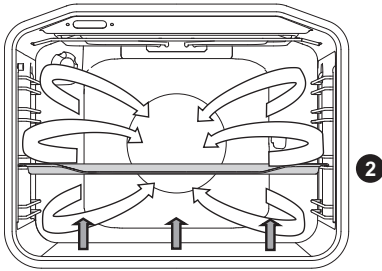

This is used for baking leavened but low-rising pastry and for preserving fruit and vegetables. Use the second guide from the bottom and a rather shallow baking tray to allow the hot air to circulate across the upper side of the dish.

Preservation:

Prepare the food to be preserved and jars as usual. Use jars with a rubber sealing ring and a glass cover. Do not use jars with threaded or metal caps or metal tins. Make sure the jars are of equal size, filled with the same contents, and tightly sealed.

Pour 1 litre of hot water into the deep tray (approx. 70 °C) and place 6 1-litre jars into the tray. Place the tray into the oven on the second guide.

During preservation, observe the food and cook until the liquid in the jars starts to simmer – when bubbles appear in the first jar.

Type of food	Guide (from the bottom)	Temperature (°C)	Time to simmer (min)	Temperature and time after the start of simmer	Resting time in the oven (min)
FRUIT					
Strawberries	2	160-180	30-45	/	20-30
Stone fruits	2	160-180	30-45	/	20-30
Fruit mush	2	160-180	30-45	/	20-30
VEGETABLES					
Pickled gherkins	2	160-180	30-45	/	20-30
Beans/carrots	2	160-180	30-45	120°C, 45-60 min	20-30

TOP AND BOTTOM HEATER WITH FAN

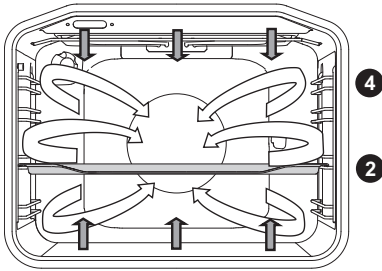

It is used for baking of all types of pastry, for defrosting, and for drying fruit and vegetables. Before placing the food into the preheated oven, wait for the light to go off for the first time. For best results, only bake on one shelf (level).

The oven should be preheated. Use the second or the fourth guide, counting from the bottom up.aj.

Table for baking pastry with upper and lower heater and the fan

Type of pastry	Guide level (from the bottom)	Temperature (°C)	Cooking time (minutes)
Marble cake	2	140-150	45-55
Cake in a rectangular baking sheet	2	130-140	45-55
Cheesecake	2	130-140	55-65
Fruit cake - shortcrust	2	140-150	35-45
Sponge cake	2	140-150	25-35
Fruit cake, sponge	2	130-140	35-45
Sponge roll	2	140-150	15-25
Christmas loaf	2	130-140	50-60
Jelly-filled rolls (Buchtel)	2	150-160	25-35
Gugelhupf (Bundt cake)	2	130-140	40-50
Shortcrust biscuits	2	140-150	15-25
Pressed cookies *	2	130-140	10-15
Small pastries, leavened dough	2	140-150	15-20
Bread*	2	170-180	45-55
Quiche Lorraine	2	150-160	35-45
Apple strudel	2	150-160	40-50
Pizza*	2	180-190	10-20
Phyllo pastry	2	150-160	18-25

The symbol * means that the oven should be preheated using the selected cooking system.

GENTLEBAKE

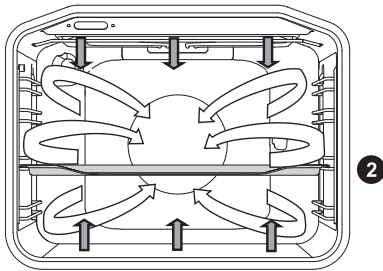

This feature allows gentle, slow, and even baking that leaves the food soft and juicy. It is suitable for roasting meat, cooking fish, and baking pastry on a single rack.

Type of food	Guide (from the bottom)	Temperature (°C)	Cooking time (minutes)
MEAT			
Pork roast, 1 kg	2	190	90 - 120
Beef roast, 1 kg	2	190	100-130
Beef tenderloin, 200 g/piece	2	180	40-50
Chicken, 1,5 kg	2	210	100 - 120
Chicken breast, fillet, 200 g/piece	2	200	45 - 60
Veal roast, 1 kg	2	180	95 - 120
FISH			
Whole fish, 200 g/piece	2	190	35 - 45
Fish fillet, 100 g/piece	2	190	25 - 35
PASTRY			
Shortcrust biscuits	2	150	25-40
Piped cookies	2	150	35-50
Small cupcakes	2	170	35-50
Sponge roll	2	170	40-55
Fruit cake, shortcrust	2	170	65-85

(Applies to appliances with pull-out or wire rails, without the hot air system. )

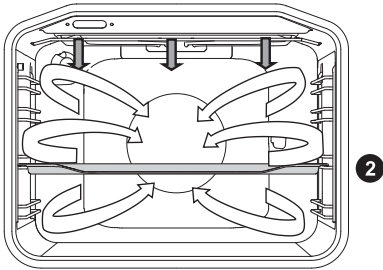

Type of food	Weight (g)	Guide level (from the bottom)	Temperature (°C)	Cooking time (min)
MEAT				
Duck	2000	2	150	90-110
Pork roast	1500	2	160	80-100
Pork shoulder	1500	2	150	130-160
Pork shank	1000	2	150	130-150
Half of chicken	700	2	190	60-70
Chicken	1500	2	190	80-100
FISH				
Trout	200 g/piece	2	200	20-30

DEFROSTING



In this mode, the air will circulate without any heaters operating.

Food suitable for defrosting includes cakes with heavy cream or butter-based cream, cakes and pastry bread and rolls, and deep-frozen fruits.

In most cases, it is recommended to remove the food from the packaging (do not forget to remove any metal clamps or clips).

Halfway through the defrost time, the pieces should be turned over, stirred and separated if they are frozen together.

PLATE WARMER



Use this function to reheat your dinnerware (plates, cups) before serving food to keep the food warm longer.

AQUA CLEAN



Only the bottom heater will radiate heat. Use this function to remove stains and food residues from the oven. The program takes 30 minutes. More detail in chapter MAINTENANCE & CLEANING.

MAINTENANCE & CLEANING



Be sure to unplug the appliance from the power supply and wait for the appliance to cool down.

Children should not clean the appliance or perform maintenance tasks without proper supervision.

Aluminium finish

Clean the aluminium finish with non-abrasive liquid cleaners intended for such surfaces. Apply the cleaner onto a wet cloth and clean the surface. Then, rinse the surface with water. Do not apply the cleaner directly onto the aluminium finish.

Do not use abrasive cleaners or sponges.

Note: The surface should not come into contact with oven cleaning sprays as this may result in visible and permanent damage.

Stainless steel sheet front side of the housing

(depending on the model)

Clean this surface only with a mild detergent (soapsuds) and a soft sponge that will not scratch the finish. Do not use abrasive cleaners or cleaners containing solvents as they may damage the housing finish.

Lacquer-coated surfaces and plastic parts

(depending on the model)

Do not clean the knobs and buttons, door handles, stickers, and rating/type plates with abrasive cleaners or abrasive cleaning materials, alcohol-based cleaners, or with alcohol. Immediately remove any stains with a soft non-abrasive cloth and some water, in order to avoid damaging the surface.

You may also use cleaners and cleaning materials intended for such surfaces as instructed by their respective manufacturers.



The aluminium-coated surfaces should not come into contact with oven cleaning sprays as this may result in visible and permanent damage.

CONVENTIONAL OVEN CLEANING

You may use the standard cleaning procedure to clean stubborn dirt in the oven (using cleaners or an oven spray). After such cleaning, rinse the cleaner residues thoroughly.

Clean the oven and the accessories after each use to prevent the dirt from burning into the surface. The easiest way to remove fat is by using warm soapsuds while the oven is still warm.

With stubborn dirt and grime, use conventional oven cleaners. Rinse the oven thoroughly with clean water to remove all cleaner residue.

Never use aggressive cleaners, abrasive cleaners, abrasive sponges, stain and rust removers etc.

Clean the accessories (baking sheets and trays, grids etc.) with hot water and detergent.

The oven, the oven cavity and the baking trays are lined with a special enamel coating for a smooth and resistant surface. This special coating makes cleaning at room temperature easier.

GAS BURNER

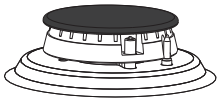

The grid, cooking surface, and burner parts may be cleaned in hot water with some washing up detergent. Do not clean them in a dishwasher.

Clean the thermocouple and the spark plug with a soft brush. These parts have to be spotlessly clean to function correctly. Clean the burner crown and cap. Make sure the slots on the burner crown are not clogged or otherwise blocked. After cleaning, thoroughly dry all the parts and reassemble them correctly. Any part placed askew will make burner ignition harder.

 Burner caps are finished in black enamel. Due to high temperatures, discoloration cannot be avoided. However, it does not affect burner operation.

USING THE AQUA CLEAN FUNCTION TO CLEAN THE OVEN

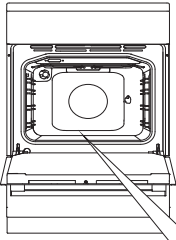

1 Turn the COOKING SYSTEM SELECTOR KNOB to Aqua Clean. Then, set the TEMPERATURE KNOB to 70 °C.

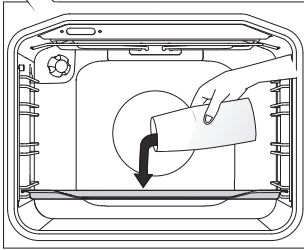

2 Pour 0.6 l water into the tray and place it into the lower guide.

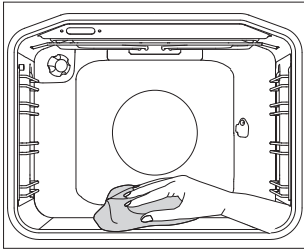

3 After 30 minutes, food residues on the oven enamel walls will have softened and they will be easy to clean with a damp cloth.



Use the Aqua Clean system when the oven has fully cooled down..

REMOVING AND CLEANING WIRE AND TELESCOPIC EXTENDIBLE GUIDES

Only use conventional cleaners to clean the guides.

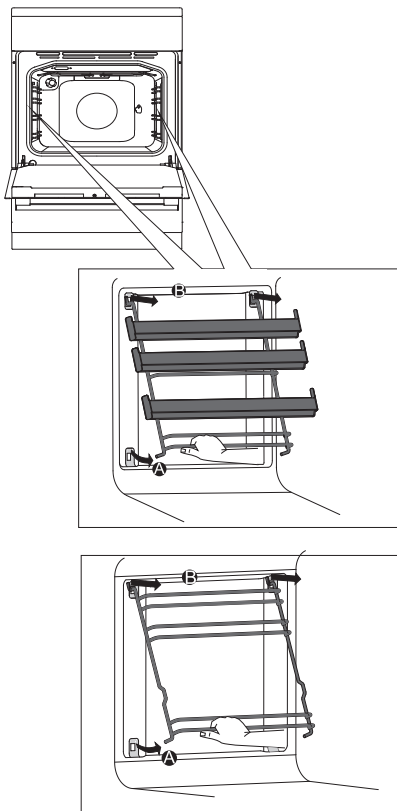

A Hold the guides by the bottom side and pull them towards the center of the oven cavity.

B Remove them from the openings at the top.

To replace the guides, observe the reverse order.

WARNING:

Do not remove the clamps inserted in the oven.



Do not clean the extendible guides in the dishwasher.

CLEANING AND INSTALLING THE CATALYTIC INSERTS

Only use conventional cleaners to clean the guides.

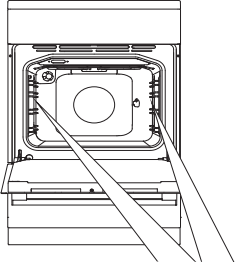

Remove the wire guides or extendible guides.

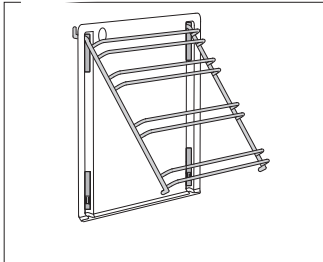

1 Mount the guides onto the catalytic insert.

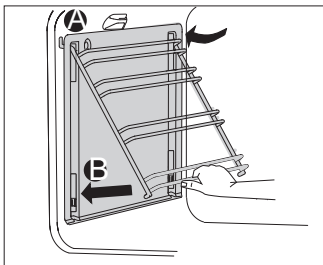

2 Hang the inserts with guides attached using the holes provided, and pull upwards.

A Insert the guide rails into the opening at the top.

B Press them into the snap lock at the bottom.



Do not wash the catalytic inserts in the dishwasher.

REMOVING AND INSERTING THE OVEN DOOR

(depending on the model)

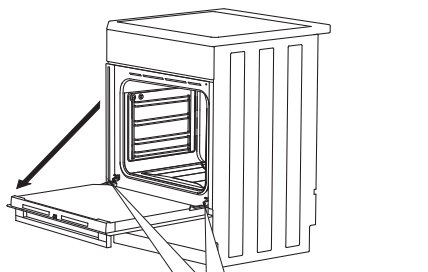

1 First, fully open the door (as far as it will go).

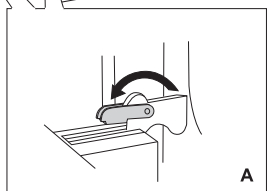

2 **A** Rotate the stoppers all the way back (in case of conventional closing).

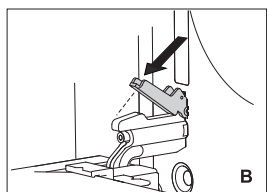

B With soft closing system, rotate the stoppers back by 90°.

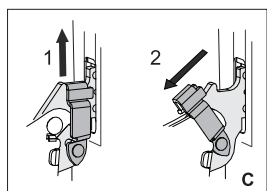

C If the appliance is fitted with the GentleClose system, slightly lift the door latches and pull them towards you.

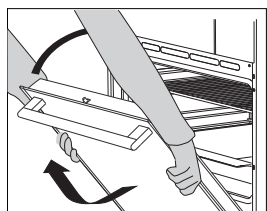

3 Slowly close the door until the latches are aligned with the slots. Slightly lift the door and pull it out from both hinge slots on the appliance.

To replace the door, follow the reverse order. If the door does not open or close properly, make sure the notches on the hinges are aligned with the hinge beds.



When replacing the door, always make sure the hinge retainers are correctly placed in the hinge beds to prevent sudden closing of the main hinge which is connected to a strong main spring. If the main spring is engaged, there is a risk of injury.

DOOR LOCK (depending on the model)

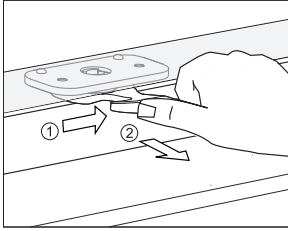

To open it, gently push it to the right with your thumb and pull the door outwards at the same time.

 **When the oven door is closed, the door lock automatically returns to the initial position.**

DEACTIVATING AND ACTIVATING THE DOOR LOCK

 **The oven should be cooled down completely.**

First, open the oven door.

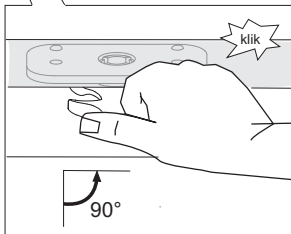
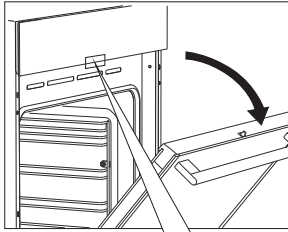

Push the door lock to the right by 90° with your thumb until you feel a click. The door lock is not deactivated.

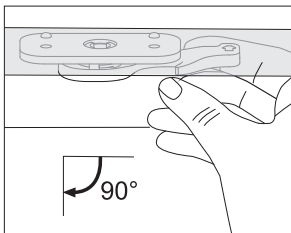

To reactivate the door lock, open the oven door and use your right-hand index finger to pull the lever towards you.

SOFT DOOR CLOSING (depending on the model)

Oven door is fitted with a system that dampens the door closing force, starting at the 75-degree angle. It allows simple, quiet, and smooth closing of the door. A gentle push (to a 15-degree angle relative to the closed door position) is enough for the door to close automatically and softly.



If the force applied to close the door is too strong, the effect of the system is reduced or the system will be bypassed for safety.

REMOVING AND INSERTING THE OVEN DOOR GLASS PANE

Oven door glass pane can be cleaned from the inside, but it has to be removed first. Remove the oven door (see chapter "Removing and replacing the oven door").

Depending on appliance model, the glass in the door is removed either as described in METHOD 1 or METHOD 2.

METHOD 1 (depending on the model)

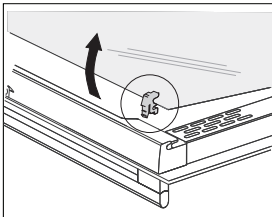
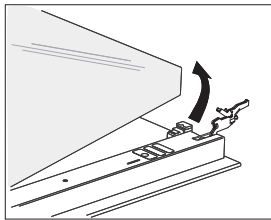
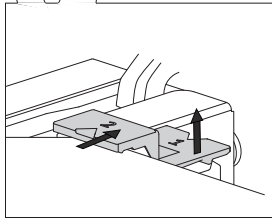
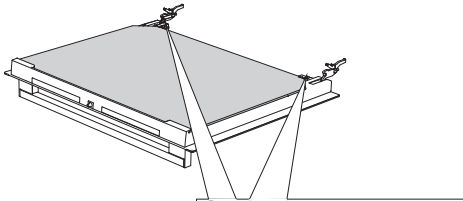

1 Slightly lift the supports on the left and right side of the door (marking 1 on the support) and pull them away from the glass pane (marking 2 on the support).

2 Hold the door glass pane by the lower edge; slightly lift it so that it is no longer attached to the support; and remove it.

3 To remove the third glass pane (only with some models), lift and remove it. Also remove the rubber seals on the glass pane.



To replace the glass pane, observe the reverse order. The markings (semicircle) on the door and the glass pane should overlap.

METHOD 2 (depending on the model)

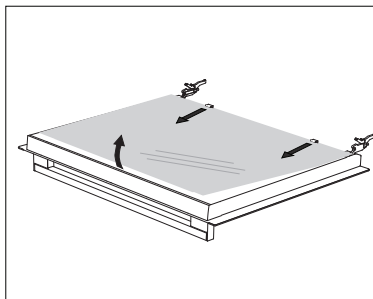
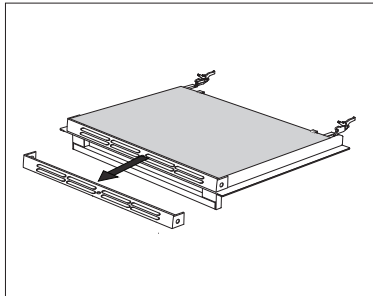
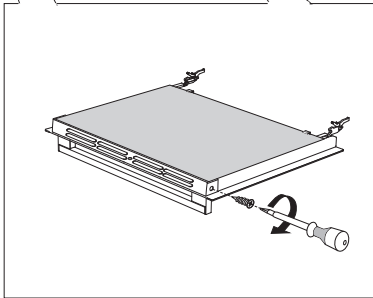
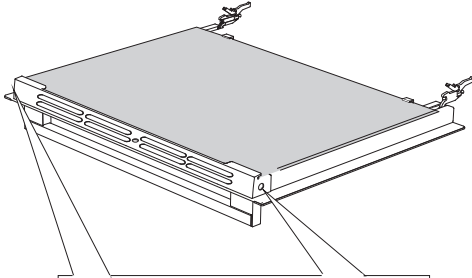

1 Undo the holder screws on both sides of the door.

2 Remove the holder.

3 Slightly lift the door glass and remove it from the clips on the bottom side of the door.

To replace the door glass, observe the reverse order.

REPLACING THE BULB

The bulb is a consumable and therefore not covered by warranty. Before changing the bulb, remove the trays, the grid, and the guides.

Disconnect the appliance from the mains power!

Use a Phillips (cross) screwdriver.

(Halogen lamp: G9, 230 V, 25 W; regular bulb E14, 25 W, 230 V)

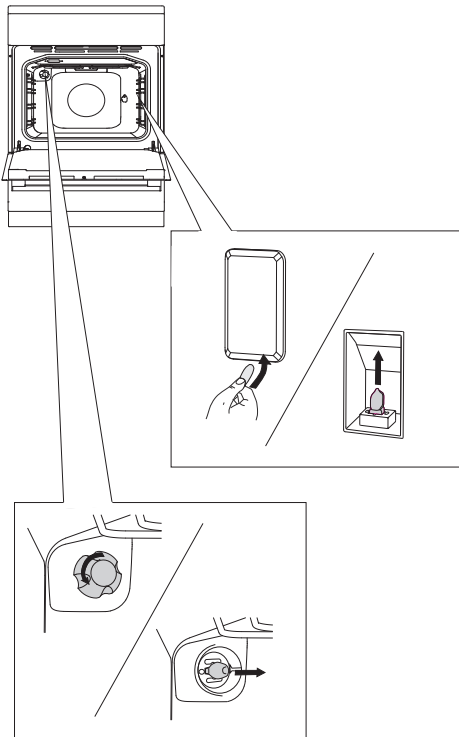

Use a flat screwdriver to release the bulb cover and remove it. Remove the bulb.

💡 Be careful not to damage the enamel.

.....
Release the bulb cover and remove the bulb.

💡 Use protection to avoid burns.

SPECIAL WARNINGS AND FAULT REPORTING

During the warranty period, only a service center authorized by the manufacturer may carry out any repairs.

Before making any repairs, make sure the appliance is disconnected from the power mains either by removing the fuse or by disconnecting the power plug from the wall outlet.

Unauthorized tampering with and repairs of the kitchen range (cooking hob) can result in electric shock or short circuit; hence, do not attempt to perform any repairs by yourselves. Leave such tasks to an expert or an authorized service unit.

In case of minor faults or problems with the appliance operation, check the following instructions to see whether you can eliminate the causes by yourselves.

IMPORTANT

A visit by a service technician during the warranty period will be charged if the appliance is not functioning because of improper use. Store these instructions in a place where they are always readily accessible; if pass the appliance on to another person, the instructions should also be included.

Following is some advice on rectifying some common problems.

There is no response of the sensors; the display is frozen.	Disconnect the appliance from the mains power for a few minutes (undo the fuse or switch off the main switch), then, reconnect the appliance and switch it on.
The main fuse in your home trips often.	Call a service technician.
The oven lighting does not work.	The process of changing the light bulb is described in the chapter Maintenance&Cleaning.
The pastry is underdone.	Did you choose the right temperature and heating system? Is the oven door closed?
The burners do not burn evenly.	Have an expert check the gas settings.
Burner flame suddenly changes, the knob has to be depressed longer to ignite the burner.	Make sure the burner is assembled correctly.
The flame is extinguished after ignition.	Hold the knob depressed for a longer period of time. Before releasing the knob, press it harder.

Problem/error	Cause
There is discolouration on the grid in the burner area.	This is a normal phenomenon resulting from high temperature. Clean the grid with a metal cleaner.
Electric burner ignition no longer works.	Carefully clean the opening between the spark plug and the burner. Clean the burner caps with a metal cleaner. Place the burner cover correctly.

If the problem persists despite observing the instructions above, call an authorized service technician. Elimination of any errors or warranty claims that resulted from improper connection or use of the appliance is not covered by our warranty. In such cases, the costs of repair are borne by the user.

INSTALLATION AND CONNECTION INSTRUCTIONS

APPLIANCE PLACEMENT (depending on the model)

(mm)

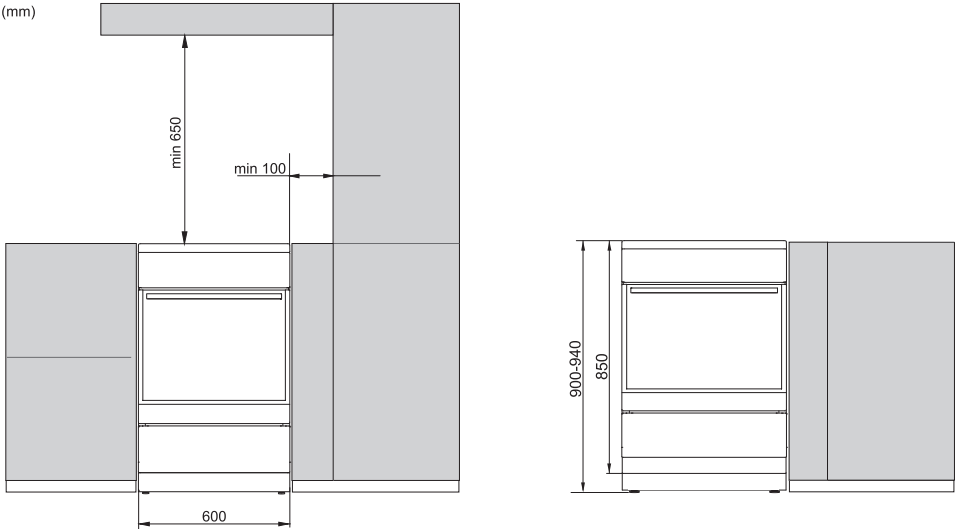

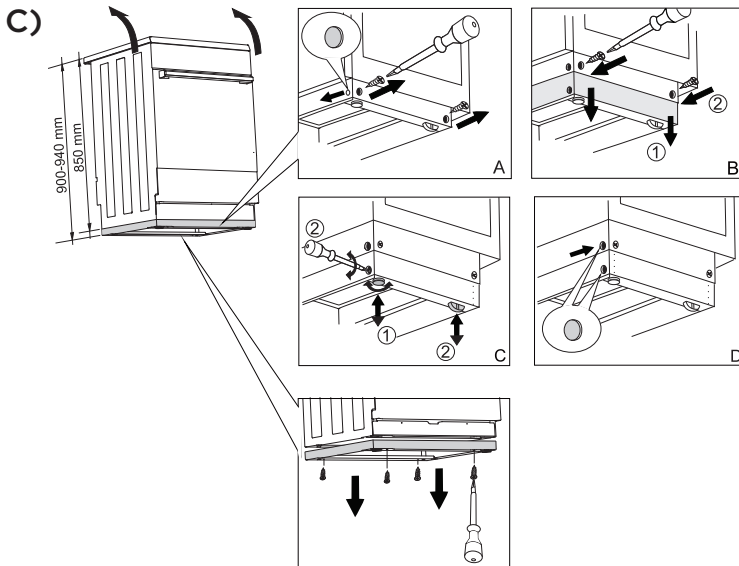
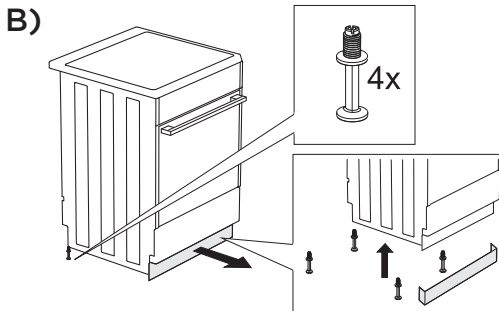
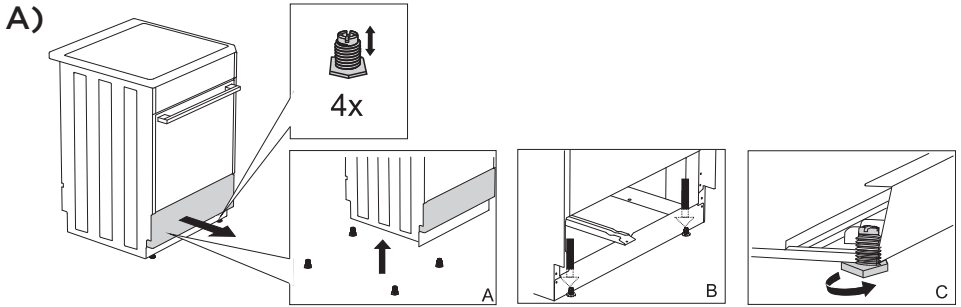

The walls or furniture adjacent to the appliance (floor, rear kitchen wall, side walls) have to be temperature-resistant to at least 90 °C.

LEVELLING THE APPLIANCE AND ADDITIONAL SUPPORT

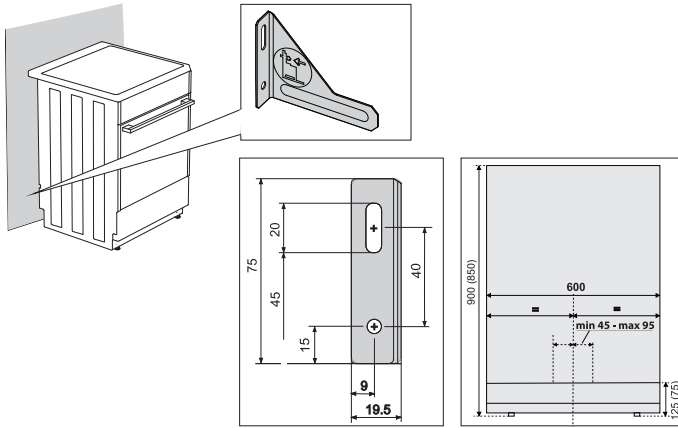

PREVENTION FROM TIPPING OVER



 Dimensions in the parenthesis represent built-in measures of the support bracket without the additional support. If the supplied element protecting the appliance from tipping over cannot be firmly secured to your wall with the screws and the wall plugs supplied, use other fittings to secure the bracket in such way that it cannot be pulled out from the wall.

CONNECTING TO THE MAINS POWER

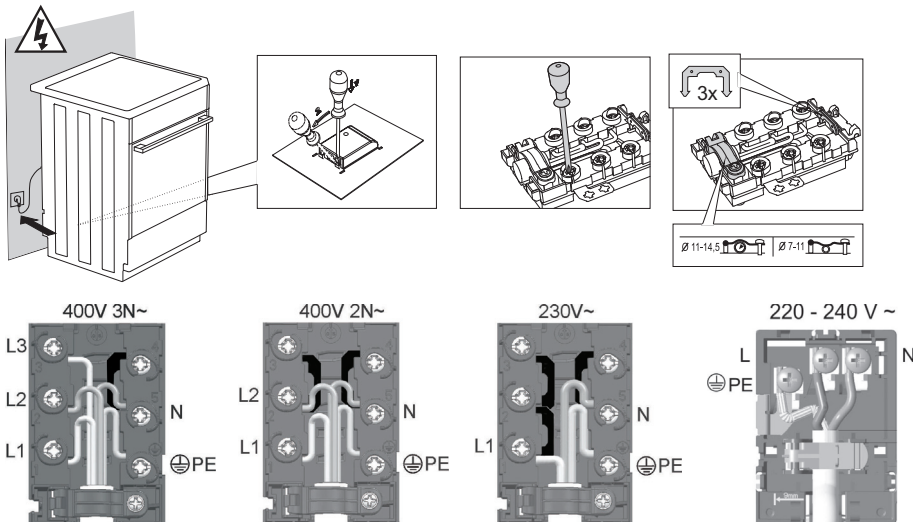

The supplied cap must be placed over the connecting clip!

GAS CONNECTIONS

FACTORY DEFAULT SETTINGS

- Gas appliances are tested and fitted with the CE sign.
- Gas appliances are supplied sealed with burners adjusted to natural gas type H or E (20 mbar), or to liquefied natural gas (50 or 30 mbar).
The information is provided on the appliance rating plate found on the interior of the oven. It is visible when the oven door is opened.
- Before connecting the appliance, make sure the local requirements for connection (gas type and pressure) are compatible with the appliance settings.
If the gas you are using is not compatible with the current settings on your appliance, call a service technician or the distributor.
- Modifying the hob to operate with a different type of gas requires replacement of the nozzles (see section NOZZLE TABLE).
- In case of repairs or if the seal is damaged, the functional parts have to be tested and re-sealed in compliance with the installation instructions. The functional parts include the following: fixed nozzle for large flame and adjustable regulation screw for small flame.

CONNECTING TO GAS SUPPLY

- Appliance has to be connected to the mains gas or the gas cylinder according to the instructions of your local gas distribution company.
- There is a gas connection plug on the right-hand side of the appliance, with external thread EN ISO 228-1 which can be converted to EN ISO 10226-1 / -2 with additional adapter and gasket (depending on the connection regulations in the specific country).
- A liquefied natural gas connection and a non-metal gasket are also supplied (depending on the model).
- When connecting the appliance to the gas supply, the connection fitting has to be held in place to prevent it from rotating.
- Use approved non-metal gaskets and approved sealants for sealing the connection joints. Use each gasket only once. The thickness of flat non-metal gaskets may be deformed up to 25%.
- Connect the appliance to the gas supply using a certified flexible hose. The hose should not touch the lower appliance wall, the back wall or the oven ceiling.

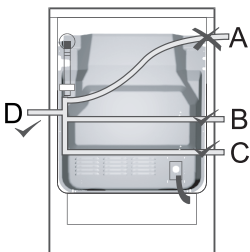

Connection with a flexible hose

If the appliance is connected with a flexible hose, the path of the hose indicated with "A" is not acceptable.

If a metal pipe is used, option A is permissible as well.

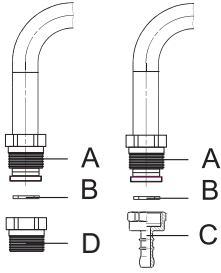

Gas connection plug

- A** Connection EN ISO 228-1
- B** Non-metal gasket, thickness 2 mm
- C** Hose plug for gas (depending on the connection regulations in the specific country)
- D** Hose plug EN ISO 10226-1/-2 (depending on the connection regulations in the specific country) (supplied, depending on the model)

After connection, check the operation of the burners. The flames have to burn with clearly visible blue and green core. If the flame is unstable, increase the minimum power as necessary. Explain to the user how the burners operate and review the instruction manual together.



After connecting the appliance, check the seal on all joints.

MODIFYING THE BURNERS FOR USE WITH A DIFFERENT TYPE OF GAS

- Modifying the burners for use with a different type of gas does not require removing the hob from the countertop.
- Before making the modifications, unplug the appliance from the mains power and shut off the gas supply valve.
- Replace the existing nozzle for the nominal heat load with suitable nozzles for the new type of gas (see table).
- When modifying the appliance for use with liquefied natural gas, tighten the minimum heat load regulation screw all the way to reach the minimum heat load.
- When modifying the appliance for use with natural gas, undo the minimum heat load regulation screw to reach the minimum heat load, but by no more than 1.5 turns.

After modifying the appliance for use with a different type of gas, replace the old sticker with gas type information (on the rating plate) with the relevant new sticker and test the functionality and sealing of the appliance.

Make sure the electric conductors, thermostat capillary and thermo elements do not protrude into the gas flow area.

Adjustment elements

- Adjustment elements for minimum heat load of the burners are accessible through the openings on the control panel.
- Remove the support grid, burner caps and burner crowns.
- Remove the control knobs.

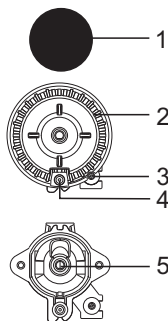

Cooking burner

1. Burner crown cap
2. Burner crown with burner cap support
3. Thermo element (only with some models)
4. Spark plug
5. Nozzle

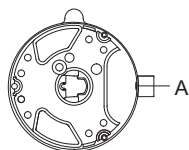

Triple (three-ring) burner

- A Nozzle

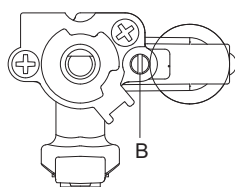

Gas valve with a safety device

- B Minimum heat load regulation screw

NOZZLE TABLE

Gas type, pressure		Auxiliary burner		Normal burner	
		max	min	max	min
Natural gas H Wo=45,7÷54,7 MJ/ m ³ , Natural gas E, Natural gas E+ Wo=40,9÷54,7 MJ/m ³ G20, p=20mbar	Nominal heat load (kW)	1	0,48	1,9	0,48
	Consumption (l/h)	95	46	181	46
	Nozzle type (1/100 mm)	72 X	26	103 Z	26
	Nozzle ID	690771		568169	
Liquefied gas 3+, B/P Wo=72,9÷87,3MJ/m ³ G30 p=30 mbar	Nominal heat load (kW)	1	0,48	1,9	0,48
	Consumption (g/h)	73	35	138	35
	Nozzle type (1/100 mm)	50	26	68	26
	Nozzle ID	690780		568175	

Gas type, pressure		Large burner		Multi-ring burner	
		max	min	max	min
Natural gas H Wo=45,7÷54,7 MJ/ m ³ , Natural gas E, Natural gas E+ Wo=40,9÷54,7 MJ/m ³ G20, p=20mbar	Nominal heat load (kW)	3	0,76	3,6	1,56
	Consumption (l/h)	286	72	343	149
	Nozzle type (1/100 mm)	130 H3	33	145 H3	57
	Nozzle ID	574285		568170	
Liquefied gas 3+, B/P Wo=72,9÷87,3MJ/m ³ G30 p=30 mbar	Nominal heat load (kW)	3	0,76	3,5	1,56
	Consumption (g/h)	218	55	255	114
	Nozzle type (1/100 mm)	86	33	94	57
	Nozzle ID	574286		568176	

Gas type, pressure		Oven burner		Infra burner
		max	min	
Natural gas H Wo=45,7÷54,7 MJ/ m ³ , Natural gas E, Natural gas E+ Wo=40,9÷54,7 MJ/m ³ G20, p=20mbar	Nominal heat load (kW)	3	0,8	2,2
	Consumption (l/h)	286	76	210
	Nozzle type (1/100 mm)	117	33	108
	Nozzle ID	568171		568173
Liquefied gas 3+, B/P Wo=72,9÷87,3MJ/m ³ G30 p=30 mbar	Nominal heat load (kW)	3	0,8	2,2
	Consumption (g/h)	218	58	160
	Nozzle type (1/100 mm)	82	33	75
	Nozzle ID	568177		568178

- Regulation screws for liquefied gas are installed and set in factory to the gas type for which the factory default settings apply.
- When modifying the appliance for use with a different type of gas, the regulation screw has to be tightened or undone to set the required gas flow (do not undo the regulation screw by more than 1.5 turns).

Burner power is indicated by observing the upper Hs caloric value.



Connection to gas supply and adjustment to a different type of gas may only be carried out by an expert authorized by the gas distributor or an authorized service technician!

DISPOSAL



Packaging is made of environmentally friendly materials that can be recycled, disposed of, or destroyed without any hazard to the environment. To this end, packaging materials are labelled appropriately.

The symbol on the product or its packaging indicates that the product should not be treated as normal household waste. The product should be taken to an authorized collection center for waste electric and electronic equipment processing.

Correct disposal of the product will help prevent any negative effects on the environment and health of people which could occur in case of incorrect product removal. For detailed information on removal and processing of the product, please contact the relevant municipal body in charge of waste management, your waste disposal service, or the store where you bought the product.

We reserve the right to any changes and errors in the instructions for use.

K_MULTI IL



en (03-22)