

GB

IE

MT

# DETAILED INSTRUCTIONS

FOR USE OF ELECTRIC  
FREE STANDING  
COOKER

**gorenje**

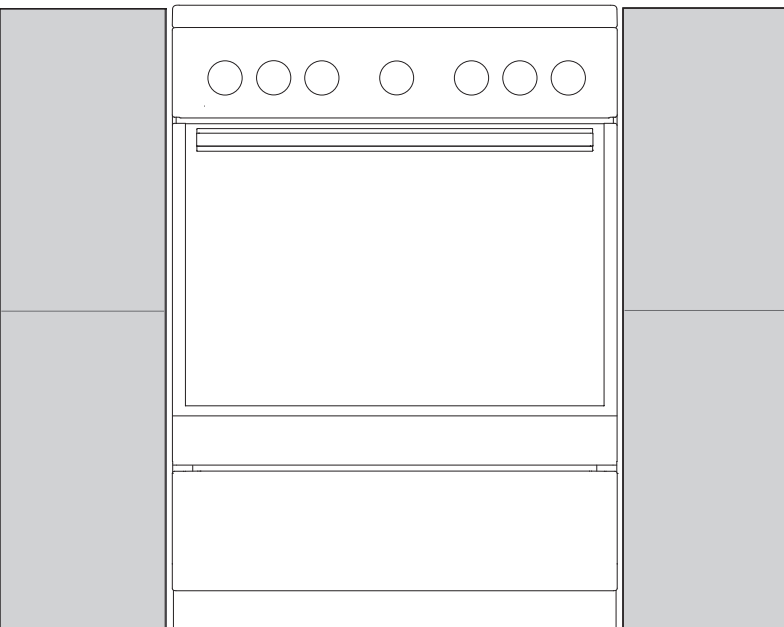
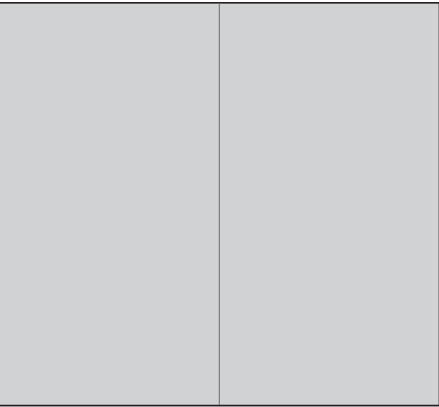

We thank you for your trust and the purchase of our appliance.

This detailed instruction manual is supplied to make the use of this product easier. The instructions should allow you to learn about your new appliance as quickly as possible.

Make sure you have received an undamaged appliance. If you do find transport damage, please contact the seller from which you purchased the appliance, or the regional warehouse from which it was supplied. The telephone number can be found on the invoice or on the delivery note.

Instructions for use are also available at our website:

[www.gorenje.com](http://www.gorenje.com)



Important information



Tip, note

# CONTENTS

---

<b>4 IMPORTANT SAFETY INSTRUCTIONS</b> 8 Before connecting the appliance  ..... <b>9 ELECTRIC FREE STANDING COOKER</b> 13 Control unit 14 Appliance data - data plate	<b>INTRODUCTION</b>
<b>15 USING THE APPLIANCE</b> 15 Before using the appliance for the first time 15 Cooking hob 19 Oven 19 Choosing the cooking system (depending on the model) 21 Choosing the settings 21 Starting the cooking process 21 Switching off the oven 22 Descriptions of cooking systems and cooking table	<b>PREPARING THE APPLIANCE FOR THE FIRST USE</b>
<b>38 MAINTENANCE &amp; CLEANING</b> 39 Cleaning the cooking hobs 39 Conventional oven cleaning 40 Cleaning the glass ceramic surface 42 Using the aqua clean function to clean the oven 43 Removing and cleaning wire and telescopic extendible guides 44 Cleaning and installing the catalytic inserts 45 Removing and inserting the oven door 48 Removing and inserting the oven door glass pane 50 Replacing the bulb	<b>MAINTENANCE &amp; CLEANING</b>
<b>51 SPECIAL WARNINGS AND FAULT REPORTING</b> ..... <b>52 INSTALLATION AND CONNECTION INSTRUCTIONS</b>	<b>TROUBLE-SHOOTING</b>
<b>55 DISPOSAL</b>	<b>OTHER</b>

# IMPORTANT SAFETY INSTRUCTIONS

---



## CAREFULLY READ THE INSTRUCTIONS AND SAVE THEM FOR FUTURE REFERENCE

This appliance can be used by children aged from 8 years and above and persons with reduced physical, sensory or mental capabilities or lack of experience and knowledge if they have been given supervision or instruction concerning use of the appliance in a safe way and understand the hazards involved. Children shall not play with the appliance. Cleaning and user maintenance shall not be made by children without supervision.

**WARNING:** The appliance and its accessible parts become hot during use. Care should be taken to avoid touching heating elements. Children younger than 8 years of age shall be kept away unless continuously supervised.

**WARNING:** The accessible parts of the appliance may become hot during use. Young children should be kept away from the oven.

The appliance becomes very hot during use. Be careful not to touch the oven heaters.

**WARNING:** Danger of fire: do not store items on the cooking surfaces.

**WARNING:** Unattended cooking on a hob with fat or oil can be dangerous and may result in fire. NEVER try to extinguish a fire with water, but switch off the appliance and then cover flame e.g. with a lid or a fire proof blanket

CAUTION: The cooking process has to be supervised. A short term cooking process has to be supervised continuously.

WARNING: Before replacing the light bulb, make sure the appliance has been disconnected from the mains power, in order to prevent the hazard of an electric shock.

CAUTION: This appliance is for cooking purposes only. It must not be used for other purposes, for example room heating.

The appliance is not intended to be controlled by external timers or separate remote control system.

WARNING: Use only hob guards designed by the manufacturer of the cooking appliance or indicated by the manufacturer of the appliance in the instructions for use as suitable or hob guards incorporated in the appliance. The use of inappropriate guards can cause accidents.

WARNING: If the surface is cracked, switch off the appliance to avoid the possibility of electric shock.

For appliance connection use a 5 x 1,5 mm<sup>2</sup> cord with mark H05VV-F5G1,5 or better. Cord must be installed by service agent or similar qualified person.

The appliance is intended to be placed directly on the floor, without any supports or plinths.

Metalic objects such as knives, forks, spoons and lids should not be placed on the hob surface since they can get hot.

After use, switch off the hob element by its control and do not rely on the pan detector.

Do not use harsh abrasive cleaners or sharp metal scrapers to clean the oven door glass or the glass of hinged lids of the hob (where appropriate), since they can scratch the surface, which may result in shattering of the glass.

The appliance must not be installed behind a decorative door in order to avoid overheating.

Do not use steam cleaners or high-pressure cleaners to clean the appliance, as this may result in an electric shock.

If the supply cord is damaged, it must be replaced by the manufacturer, its service agent or similarly qualified persons in order to avoid a hazard.



- CAUTION: possibility of tilting.



- WARNING: In order to prevent tipping of the appliance, stabilising means must be installed. Refer to the instructions for installation.

Only use the temperature probe recommended for this oven.

Make sure the lid is clean and that there is no liquid spilt on it before raising it. The lid may be lacquer-coated or glass. It may only be closed when the cooking zones have completely cooled down.

Appliance must be connected to fixed wiring which is in accordance with the wiring rules.

Appliance must be connected to fixed wiring which has incorporated means of disconnection. Fixed wiring must be made in accordance with the wiring rules.

**The appliance is intended for household use.** Do not use it for any other purpose, such as room heating, drying of pets or other animals, paper, fabrics, herbs etc. As this may lead to injury or fire hazard.

Unauthorized service and repair can result in risk of explosion, electric shock, or short circuit and consequently personal injury and damage to the appliance. Such tasks may only be carried out by an authorized expert.

The set-up of the appliance is specified on the rating plate.

This appliance is not connected to a combustion products evacuation device. It shall be installed and connected in accordance with current installation regulations. Particular attention shall be given to the relevant requirements regarding ventilation.

Oven door hinges may be damaged when under excessive load. Do not place heavy pans on open oven door and do not lean against open oven door when cleaning the oven cavity. Never stand on the open oven door and do not let children sit on it.

Appliance operation is safe with and without tray guides.

**Do not line the oven walls** with aluminium foil and do not place baking trays or other cookware on the oven bottom. Aluminium foil would prevent air circulation in the oven, hinder the cooking process, and ruin the enamel coating.

**Oven door become very hot** during operation.

A third glass is installed for extra protection, reducing the temperature of the outside surface (only with some models).

**Oven door hinges** may be damaged when under excessive load. Do not place heavy pans on open oven door and do not lean against open oven door when cleaning the oven cavity.

Never stand on the open oven door and do not let children sit on it.

Make sure the vents are never covered or obstructed in any other way.

The appliance is heavy. For carrying the appliance at least 2 persons are needed.

## BEFORE CONNECTING THE APPLIANCE



Carefully read the instructions for use before connecting the appliance. Repair or any warranty claim resulting from incorrect connection or use of the appliance shall not be covered by the warranty.



# ELECTRIC FREE STANDING COOKER

## DESCRIPTION OF THE APPLIANCE AND EQUIPMENT (depending on the model)

Since the appliances for which these instructions were drawn up may have different equipment, some functions or equipment may be described in the manual that may not be present in your appliances.

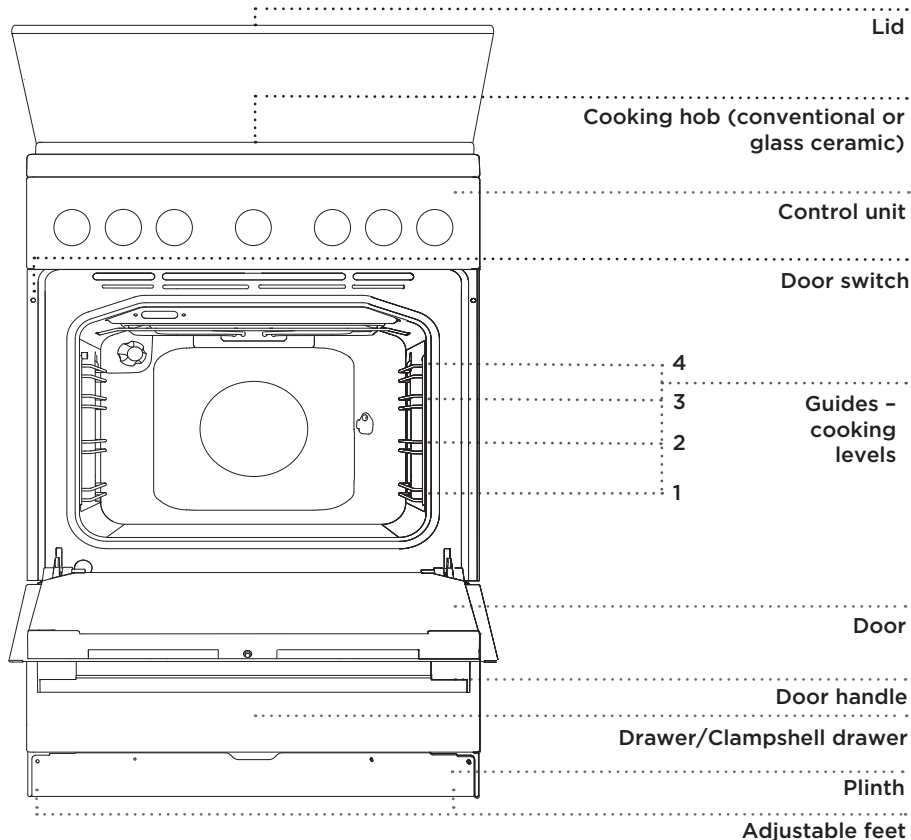

## APPLIANCE LID

Make sure the lid is clean and that there is no liquid spilt on it before raising it. The lid may be lacquer-coated or glass. It may only be closed when the cooking zones have completely cooled down.



The symbol on the product or its packaging indicates that glass lids may shatter when heated. Turn off all the burners before shutting the lid.

## APPLIANCE DRAWER



Do not store combustible, explosive, volatile or temperature-sensitive items (such as paper, dish cloths, plastic bags, cleaners or detergents and spray cans) in the oven's storage drawer, as they can ignite during excessive operation and cause a fire.

## PUSH-PULL KNOB

Slightly push the knob until it pops out; then, rotate it.



After each use, rotate the knob back to the "off" position and push it back in. The push-pull knob can only be pushed back when the switch is in the "off" position.

## CONTROL LIGHT

When the oven is switched on, the **yellow signal light** is on.

**The yellow light** is on whenever any appliance function is activated (depending on the model).

**The red light** is on when the oven heaters are activated. When the selected temperature is reached, the red light is switched off.

**When a function is selected**, the dial of the selected knob will be lit up. These appliances do not have a yellow light (only with some models).

**Oven lighting** will be switched on automatically when the cooking system is selected.

## WIRE GUIDES

The wire guides allow preparation of the food on four levels.

## TELESCOPIC PULL-OUT GUIDES

Telescopic pull-out guides may be fitted for the 2nd, 3rd, and 4th level.

Pull-out guides can be partly or fully extendible.

## EMBOSSSED GUIDES

The oven has stamped side grooves in three levels for inserting of the grid.

## OVEN DOOR SWITCH

The switch deactivates oven heating and the fan when the oven door is opened during the cooking process. When the door is closed, the switch turns the heaters back on.

## COOLING FAN

The appliance is fitted with a cooling fan that cools the housing, door and the appliance control panel.

After the oven is switched off, the cooling fan continues to operate for a short while in order to cool the oven.

## OVEN EQUIPMENT AND ACCESSORIES (depending on the model)



**GLASS BAKING DISH** is used for cooking with all oven tray systems. It can also be used as a serving tray.



The **GRID** is used for grilling or as support for a pan, baking tray or baking dish with the food.



There is a safety latch on the grid. Therefore, lift the grid slightly at the front when pulling it out from the oven.

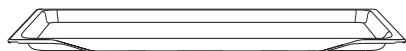

The **SHALLOW BAKING SHEET** is used for baking pastry and cakes.

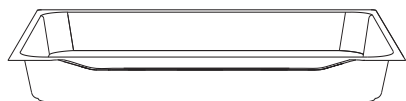

The **DEEP BAKING TRAY** is used for roasting meat and baking moist pastry. It can also be used as a drip tray.



Never place the deep baking tray in the first guide during the cooking process, except when grilling food or using the roasting spit and you are only using the deep tray as a drip tray.



**As baking accessories heat up, their form may change. This does not affect their functionality and their original form will be restored when they cool down.**

The grid or the tray should always be inserted into the groove between the two wire profiles.

Rešetka naj bo vstavljena tako, da je ograjica v notranjosti pečice.

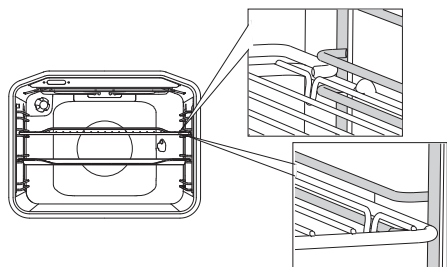

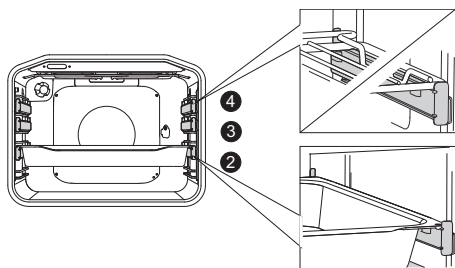

With telescopic extendible guides, first pull out the guides of one level and place the grid or the baking tray onto them. Then, push them in with your hand as far as they will go.

 Close the oven door when the telescopic guides are retracted all the way into the oven.

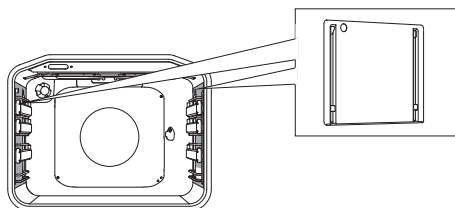

**CATALYTIC INSERTS** prevent the spraying fat from sticking to sides of the oven cavity.



The **TURNSPIT** (meat skewer) is used for roasting meat. The set consists of a skewer support, skewer with screws, and a removable handle.



The appliance and some of the accessible parts tend to heat up during cooking. Use oven mitts.

# CONTROL UNIT

(depending on the model)

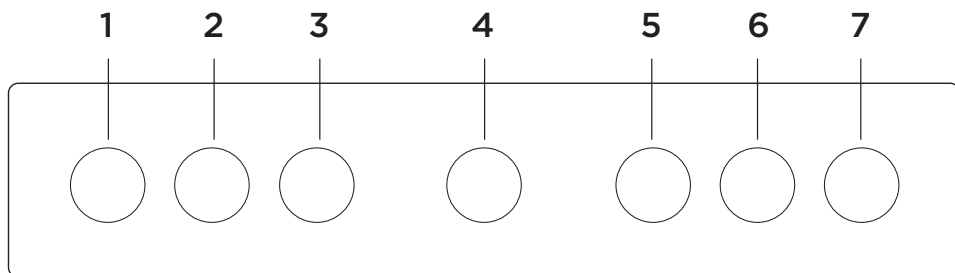

- 1 COOKING ZONE KNOB, FRONT LEFT
- 2 COOKING ZONE KNOB, REAR LEFT
- 3 COOKING SYSTEM SELECTOR KNOB
- 4 MINUTE MINDER, COUNTDOWN TIMER (depending on the model)
- 5 TEMPERATURE KNOB
- 6 COOKING ZONE KNOB, REAR RIGHT
- 4 COOKING ZONE KNOB, FRONT RIGHT

## NOTE:

Symbols of cooking systems may be located on the knob or on the front panel (depending on the appliance model).

The keys will respond better if you touch them with a larger area of your fingertip. Each time you press a key, a short acoustic signal will be sounded.

# APPLIANCE DATA - DATA PLATE

(depending on the model)

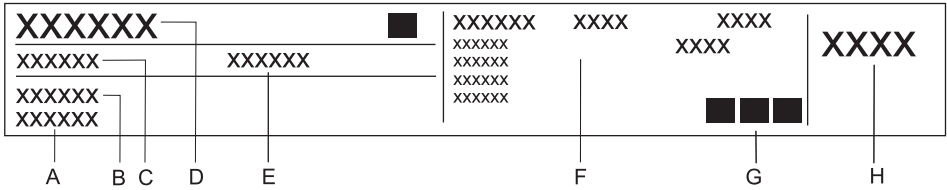

- A Serial number
- B Model
- C Type
- D Trademark
- E Code
- F Technical information
- G Compliance indications / symbols
- H Factory settings for gas type

The rating plate indicating the basic information about the appliance is located at the edge of the oven and it is visible when the oven door is opened.

# USING THE APPLIANCE

---

## BEFORE USING THE APPLIANCE FOR THE FIRST TIME

**Upon receiving the appliance,** remove all parts, including any transport equipment, from the oven.

Clean all accessories and utensils with warm water and regular detergent. Do not use any abrasive cleaners.

**When the oven heats up for the first time,** the characteristic smell of a new appliance will be emitted. Ventilate the room thoroughly during the first operation.

After you receive your appliance, please wipe the entire cooking hob, including the cooking zones, with a damp cloth

If your **cooking hob** has conventional cooking zones, switch them on to the maximum power for 3 to 5 minutes without any cookware on them. As the cooking zones heat up, some smoke may appear on the cooking hob surface. Thus, the cooking zone finish reaches its maximum resistance.

If your hob has a **glass ceramic** surface, clean it with a damp cloth and some washing-up liquid. Do not use aggressive cleaners, such as abrasive cleaners that could cause scratches, abrasive dishwashing sponges, or stain removers.

## COOKING HOB

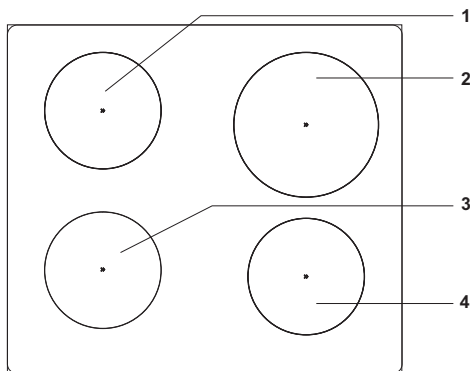

- 1 Cooking zone rear left
- 2 Cooking zone rear right
- 3 Cooking zone front left
- 4 Cooking zone front right

## CONVENTIONAL HOBS

- Make sure the cooking zone and the cookware bottom is clean and dry. This will allow better conduction of heat and prevent any damage to the heating surface.
- Overheated fat and oil on the cooking zones may ignite. Therefore, be careful when cooking with fat or oil and always control the cooking process.
- Do not place wet cookware or lids covered in steam on the cooking zones. Moisture may damage the cooking zones.
- Do not cool down the hot cookware by placing it on the cooking zones that were not in use, because the condensate that will appear under the cookware bottom may aid corrosion.

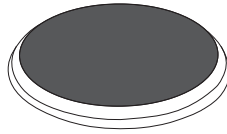
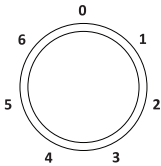

Rotate the knob to switch on the cooking zone. Cooking zone heating power can be set in steps from 1 to 6 or continuously from 1 to 4.

 Switch off the cooking zone 3 - 5 minutes before the end of the cooking process to make use of the residual heat and save power.

 **Rapid cooking zones** (only with some models) can operate with greater power than regular cooking zones, which means they can heat up more quickly. These cooking zones are indicated with a **red dot** in the middle. After repeated heating and cleaning, this dot may disappear.



**In case of prolonged use of cast iron plates, the area of the plate and the edge of the cooking zone may discolour. Service in such case is not covered by the warranty.**



## GLASS CERAMIC COOKING SURFACE

- The heating zone will quickly reach the set power or temperature, while the area around the hot cooking zones will remain cool.
- The hob is resistant to temperature changes.
- Using the glass ceramic hob as a storage area may result in scratches or other damage to it.
- Do not use aluminium or plastic cookware on hot cooking zones. Do not place any plastic objects or aluminium foil on the glass ceramic hob.
- Do not use the glass ceramic hob if it is cracked or broken. If a sharp object falls on the hob, the hob may break. The consequences of such occurrence may be visible immediately or only after a while. If any visible crack appears in the hob, immediately cut off the power supply to the appliance.

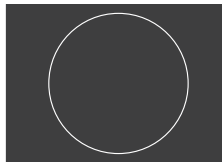
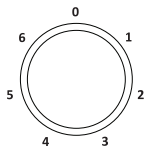

### CONTROLLING A SINGLE-ZONE COOKING HOB

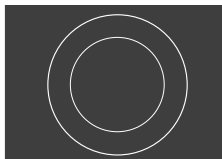
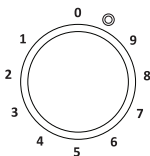
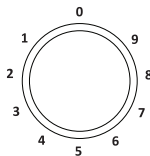

### CONTROL OF THE TWO-RING COOKING ZONE:

The area of the two-ring cooking zone can adapt to the size and the form of your cookware.

To activate the larger heating zone, rotate the cooking zone knob as far as it will go (a click will be heard), then set the desired power level.

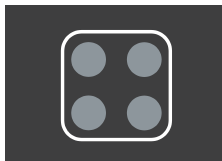
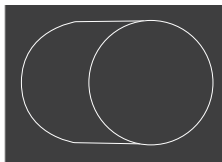

### RESIDUAL HEAT INDICATOR

Every cooking zone has a signal light that lights up when the cooking zone is hot. When the cooking zone cools down, the signal light goes out. The residual heat indicator may also light up if a hot pot or pan is placed on a cool cooking zone.

## TIPS REGARDING YOUR COOKWARE

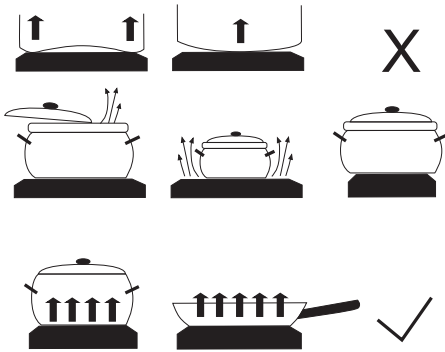

- Use quality cookware with flat and stable bottom.
- Pan bottom and cooking zone diameters should be the same.
- Tempered glass cookware with special ground bottom may be used on the cooking zones if its diameter fits that of the cooking zones. Cookware with larger diameter may crack due to thermal tension.
- Make sure the pot or pan is in the middle of the cooking zone.

- When using a pressure cooker, keep an eye on it until the right pressure is reached. First, set the cooking zone to maximum power; then, following the pressure cooker manufacturer's instructions, use the relevant sensor to decrease the cooking power at the right time.
- Make sure there is enough liquid in the pressure cooker, or any other pot or pan. Due to overheating, using an empty pot on the cooking zone may result in damage to both the pot and the cooking zone.
- When using special cookware, observe the manufacturer's instructions.

## ENERGY SAVING TIPS

- Diameter of the pot and pan bottoms should match the diameter of the cooking zone. If the pot or pan is too small, a part of the heat will be lost, and the cooking zone may be damaged.
- If the cooking process allows, use a lid.
- Cookware should be suitably sized given the amount of food. When you cook a small amount of food in a large pot or pan, more energy is lost.
- If a dish takes a long time to cook, use a pressure cooker.
- Vegetables, potatoes etc. may be cooked in a smaller amount of water. The food will cook just as well, as long as the pot is tightly closed with a lid. After bringing the water to a boil, reduce the heat to a level that just suffices to maintain a slow simmer.

# OVEN

## CHOOSING THE COOKING SYSTEM

(depending on the model)

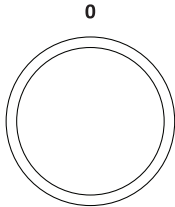

Rotate the knob (left and right) to select the cooking system (see program table, depending on the model).



Settings can also be changed during the cooking process.

SYSTEM	DESCRIPTION	SUGGESTED TEMPERATURE °C
<b>COOKING SYSTEMS</b>		
»»»»	<b>RAPID PREHEAT</b> Use this function if you wish to heat the oven to the desired temperature as quickly as possible. This function is not appropriate for cooking food. When the oven heats up to the desired temperature, the heating process is completed.	160
==	<b>TOP AND BOTTOM HEATER</b> The heaters in the bottom and in the ceiling of the oven cavity will radiate heat evenly into the oven interior. Pastry or meat can only be baked/roasted a single height level.	200
==	<b>TOP HEATER</b> Only the heater on the oven cavity ceiling will radiate heat onto the food. Use it to brown the upper side of your dish (final browning).	180
==	<b>BOTTOM HEATER</b> Only the heater on the bottom of the oven cavity will radiate heat. Use this heater to brown the lower side of the dish.	180
▼▼	<b>GRILL</b> Only grill heater (a part of the large grill set) will operate. This system is used for grilling a smaller amount of open sandwiches or beer sausages, and for toasting bread. Maximal allowed temperature: 230°C	220
▼▼▼	<b>LARGE GRILL</b> The upper heater and the grill heater will operate. The heat is radiated directly by the grill heater installed in the oven ceiling. To boost the heating effect, the upper heater is activated as well. This combination is used for grilling a smaller amount of open sandwiches, meat or beer sausages and for toasting bread. Maximal allowed temperature: 230°C	220



SYSTEM	DESCRIPTION	SUGGESTED TEMPERATURE °C
	<b>GRILL WITH FAN</b> Grill heater and the fan will operate. This combination is used to grill meat and to roast larger chunks of meat or poultry on a single height level. It is also appropriate for dishes "au gratin" and for browning to a crispy crust.	170
	<b>TOP HEATER AND FAN</b> The top (upper) heater and the fan will operate. Use this system to roast larger chunks of meat and poultry. It is also suitable for dishes au gratin.	170
	<b>HOT AIR AND BOTTOM HEATER</b> The bottom heater, the round heater, and the hot air fan will operate. This is used to bake pizza, moist pastry, fruitcakes, leavened dough and shortcrust.	200
	<b>HOT AIR</b> Round heater and the fan will operate. The fan, installed in the back wall of the oven cavity, makes sure the hot air constantly circulates around the roast or pastry. This mode is used for roasting meat and baking pastry.	180
	<b>BOTTOM HEATER AND FAN</b> This is used for baking leavened but low-rising pastry and for preserving fruit and vegetables.	180
	<b>TOP AND BOTTOM HEATER WITH FAN</b> Both heaters and the fan are activated. The fan allows even circulation of hot air inside the oven. It is used for baking pastry, for defrosting, and for drying fruits and vegetables.	180
	<b>PLATE WARMER</b> Use this function to reheat your dinnerware (plates, cups) before serving food in it to keep the food warm longer.	60
	<b>GENTLEBAKE <sup>1)</sup></b> This feature allows gentle, slow, and even baking that leaves the food soft and juicy. It is suitable for roasting meat, cooking fish, and baking pastry on a single rack. Set the temperature in the range from 140 to 220 °C.	180
	<b>DEFROSTING</b> The air circulates with no heaters activated. Only the fan will be activated. This is used to slowly thaw frozen food.	-
	<b>AQUA CLEAN</b> Only the bottom heater will radiate heat. Use this function to remove stains and food residues from the oven. The program takes 30 minutes.	70

<sup>1)</sup> It is used for determining the energy efficiency class pursuant to the EN 60350-1 standard.

# CHOOSING THE SETTINGS

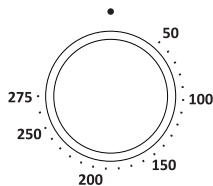
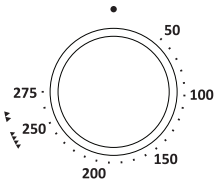
## ADJUSTING THE COOKING TEMPERATURE



 Set the temperature knob to the position  when using the oven system with the large grill and grill.

## SETTING THE CLOCK

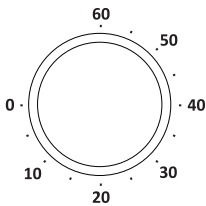

### MINUTE MINDER

Rotate the knob in the clockwise direction to set the time. Then, fine tune your setting by rotating the knob in the opposite direction. The longest possible setting is 60 minutes. Once the set time expires, an acoustic signal lasting approximately five seconds will be activated.

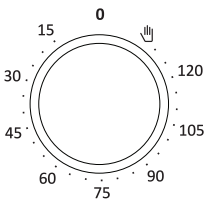

### SWITCH-OFF TIMER (timer switch)

First select the cooking system and temperature. Set the time by rotating the knob in the clockwise direction. After the set time expires, the selected heating system will be deactivated.

 If you do not wish to use the timer switch or if the time is either shorter than 15 minutes or longer than 120 minutes, then the manual setting is recommended. Rotate the knob to the left to select the symbol (hand). In the "0" position the oven will not operate.

## STARTING THE COOKING PROCESS

Set the system and the temperature, then, start the cooking process.

## SWITCHING OFF THE OVEN

Turn the COOKING SYSTEM SELECTOR KNOB to position "0".

 After the cooking process, the cooling fan will continue to operate for a while, depending on the temperature. If you leave your food in the oven, moisture can be released from it and cause condensation on the oven front panel and door.

# DESCRIPTIONS OF COOKING SYSTEMS AND COOKING TABLE

If your desired food cannot be found in the cooking table, find information for similar food. The information displayed applies to cooking on a single level.

An interval of suggested temperature is indicated. Start with a lower temperature setting and increase it if you find the food is not browned sufficiently.

**Only preheat the oven** if required by the recipe in the tables in this instruction manual. Heating an empty oven consumes a lot of energy. Hence, baking several types of pastry or several pizzas successively will save a lot of energy, as the oven will already be preheated.

Use dark, black silicon-layered or enamel-coated baking sheets and trays as they conduct the heat very well.

When using parchment paper, make sure it is resistant to high temperatures.

When cooking larger chunks of meat or pastry, a lot of steam will be generated inside the oven, which in turn may condense on the oven door. This is a normal phenomenon which will not affect the operation of the appliance. After the cooking process, wipe the door and the door glass dry.

**Switch off the oven approximately** 10 minutes before the end of the cooking process to save energy by making use of the accumulated heat.

Do not cool the food in a closed oven to prevent condensation (dew).

## Standard doneness levels and recommended final core temperature for different types of meat

Type of food	Food core temperature (°C)	Meat colour on cross-section, and colour of juices
<b>BEEF</b>		
Rare	40-45	meaty red, like raw meat, little juice
Medium rare	55-60	light red, a lot of light red juice
Medium	65-70	pink, small amount of pale pink juice
Well done	75-80	evenly greyish brown, little colourless juice
<b>VEAL</b>		
Well done	75-85	red-brown
<b>PORK</b>		
Medium	65-70	light pink
Well done	75-85	yellow-brown
<b>LAMB</b>		
Well done	79	grey, pinkish juice
<b>MUTTON</b>		
Rare	45	meaty red
Medium rare	55-60	light red
Medium	65-70	pink in the middle
Well done	80	grey
<b>GOAT MEAT</b>		
Medium	70	pale pink, pink juices
Well done	82	grey, juices only slightly pink
<b>POULTRY</b>		
Well done	82	light grey
<b>FISH</b>		
Well done	65-70	white to grey-brown

## TOP AND BOTTOM HEATER

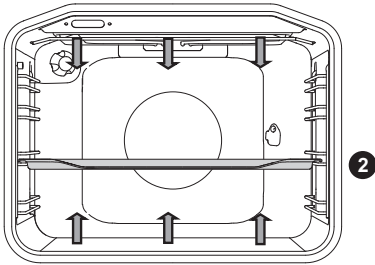

The heaters in the bottom and in the ceiling of the oven cavity will radiate heat evenly into the oven interior.

### Roasting meat:

Use enamel coated, tempered glass, clay, or cast iron pan or tray. Stainless steel trays are not suitable as they strongly reflect the heat.

Provide enough liquid during the cooking process to prevent the meat from burning. Turn the meat during cooking. The roast will remain juicier if you cover it.

Type of food	Weight (g)	Guide (from the bottom)	Temperature (°C)	Cooking time (minutes)
<b>MEAT</b>				
Pork roast	1500	2	180-200	90-110
Pork shoulder	1500	2	180-200	100-120
Pork roulade	1500	2	180-200	120-140
Meat loaf	1500	2	200-210	60-70
Beef roast	1500	2	170-190	120-140
Veal roulade	1500	2	180-200	90-120
Lamb sirloin	1500	2	180-200	80-100
Rabbit loin	1500	2	180-200	50-70
Deer shank	1500	2	180-200	100-120
Pizza*	/	2	200-220	20-30
Chicken	1500	2	190-210	70-90
<b>FISH</b>				
Braised fish	1000	2	210	50-60

Use this system to roast chicken, if the appliance does not have the  system.

Use this system to bake pizza, if the appliance does not have the  system.

The symbol \* means that the oven should be preheated using the selected cooking system.



### Baking pastry:

Only use one level and dark baking sheets or trays. In light-coloured baking sheets or trays, the browning of the pastry will be poorer, as such equipment will reflect the heat. Always place the baking trays on the grid. If you are using the supplied baking sheet, remove the grid. Cooking time will be shorter if the oven is preheated.

Type of food	Guide (from the bottom)	Temperature (°C)	Cooking time (minutes)
<b>PASTRY</b>			
Vegetable soufflé	2	190-200	30-35
Sweet soufflé	2	190-200	30-35
Rolls*	2	190-210	20-30
White bread*	2	180-190	50-60
Buckwheat bread*	2	180-190	50-60
Whole grain bread*	2	180-190	50-60
Rye bread*	2	180-190	50-60
Spelt bread*	2	180-190	50-60
Walnut cake	2	170-180	50-60
Sponge cake*	2	160-170	25-30
Cheesecake	2	170-180	65-75
Cupcakes	2	170-180	25-30
Small pastries made with yeast dough	2	200-210	20-30
Cabbage pirozhki	2	185-195	25-35
Fruitcake	2	150-160	40-50
Meringue cookies	2	80-90	120-130
Jelly-filled rolls (Buchtel)	2	170-180	30-40

The symbol \* means that the oven should be preheated using the selected cooking system.



**Do not insert the deep baking tray into the first guide.**

## LARGE GRILL, GRILL

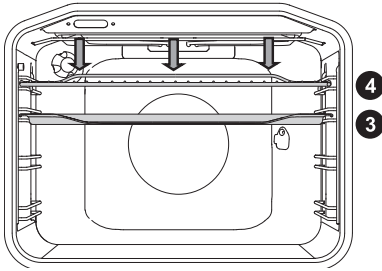

When grilling food with the large grill, the upper heater and the grill heater fitted on the ceiling of the oven cavity will operate.

When grilling food, the upper heater and the grill heater fitted on the ceiling of the oven cavity will operate.

Max allowed temperature : 240°C

Preheat the infrared (grill) heater for 5 minutes.

Supervise the cooking process at all times. The meat may burn quickly due to high temperature.

Roasting with the grill heater is suitable for crispy and low-fat cooking of bratwurst, cuts of meat and fish (steaks, escalopes, salmon steaks or fillets etc.) or toasted bread.

When grilling directly on the grid, smear it with oil to prevent the meat from sticking onto it and insert it into the 4th guide. Insert the drip tray in to the 1st or 2nd guide. When grilling in a baking tray, make sure there is enough liquid in the tray to prevent burning. Turn the meat during cooking.

After grilling, clean the oven, the accessories, and the utensils.

### Grilling table - small grill

Type of food	Weight (g)	Guide (from the bottom)	Temperature (°C)	Cooking time (minutes)
<b>MEAT</b>				
Beefsteak, rare	180 g/piece	3	230	15-20
Pork neck fillet	150 g/piece	3	230	18-22
Cutlets/chops	280 g/piece	3	230	20-25
Grill sausages	70 g/piece	3	230	10-15
<b>TOASTED BREAD</b>				
Toast	/	4	230	3-6
Open sandwiches	/	4	230	3-6

## Grilling table - large grill

Type of food	Weight (g)	Guide (from the bottom)	Temperature (°C)	Cooking time (minutes)
<b>MEAT</b>				
Beefsteak, rare	180 g/piece	3	230	15-20
Beefsteak, well done	180 g/piece	3	230	18-25
Pork neck fillet	150 g/piece	3	230	20-25
Cutlets/chops	280 g/piece	3	230	20-25
Veal escalope	140 g/piece	3	230	20-25
Grill sausages	70 g/piece	3	230	10-15
Spam (Leberkäse)	150 g/piece	3	230	10-15
<b>FISH</b>				
Salmon steaks/fillets	200 g/piece	3	230	15-25
<b>TOASTED BREAD</b>				
Toast	/	4	230	1-3
Open sandwiches	/	4	230	2-5

When grilling in a baking tray, make sure there is enough liquid in the tray to prevent burning. Turn the meat during cooking.

When baking trout, pat the fish dry with a paper towel. Season on the inside; coat with oil on the outside and place on the grid. Do not turn the fish when grilling.



**Always keep the oven door closed when using the grill (infrared) heater.**

**Grill heater, grid, and other oven accessories get very hot during grilling. Therefore, use oven mitts and meat tongs.**

## Cooking with the turnspit (depending on the model)



Maximum temperature when using the rotisserie is 230°C.

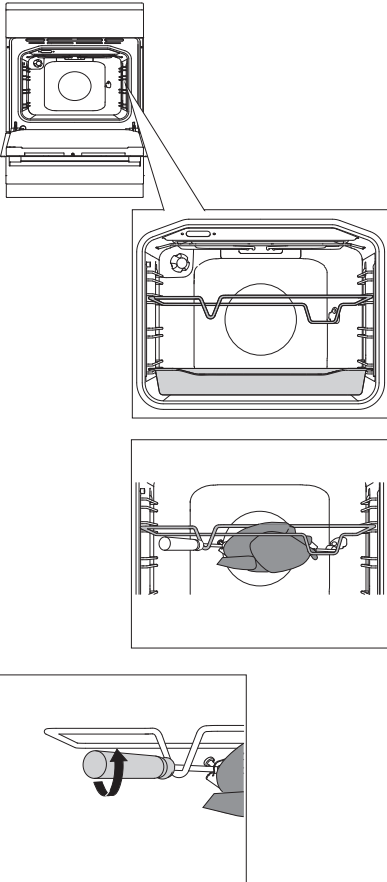

**1** Insert the skewer support into the 3rd guide from the bottom and place the deep tray into the bottom (1st) guide to serve as a drip tray.

**2** Impale the meat on the skewer and tighten the screws.

Place the skewer handle on the front skewer support and insert the tip into the opening in the right hand side of the rear oven cavity wall (the opening is protected with a rotating cover).

**3** Undo the skewer handle and close the oven door.

Switch on the oven and select the LARGE GRILL system



The grill will only operate when the oven door is closed.

## GRILL WITH FAN

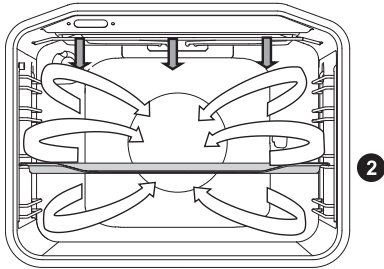

The bottom heater, the round heater, and the hot air fan will operate. Suitable for baking pizzas, apple pies, and fruitcakes.

Type of food	Weight (g)	Guide level (from the bottom)	Temperature (°C)	Cooking time (min)
<b>MEAT</b>				
Duck	2000	2	150-170	80-100
Pork roast	1500	2	160-170	60-85
Pork shoulder	1500	2	150-160	120-160
Pork shank	1000	2	150-160	120-140
Half of chicken	700	2	190-210	50-60
Chicken	1500	2	190-210	60-90
<b>FISH</b>				
Trout	200 g/piece	2	200-220	20-30

## HOT AIR AND BOTTOM HEATER

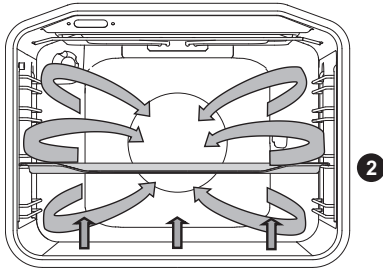

The bottom heater, the round heater, and the hot air fan will operate. Suitable for baking pizzas, apple pies, and fruitcakes.

(See descriptions and tips for UPPER and BOTTOM HEATER.)

Type of food	Guide (from the bottom)	Temperature (°C)	Cooking time (minutes)
Cheesecake, short crust	2	150-160	65-80
Pizza *	2	200-210	15-20
Quiche Lorraine, shortcrust	2	180-200	35-40
Apple pie, leavened dough	2	150-160	35-40
Apple strudel, phyllo dough	2	170-180	45-65

The symbol \* means that the oven should be preheated using the selected cooking system.

## HOT AIR

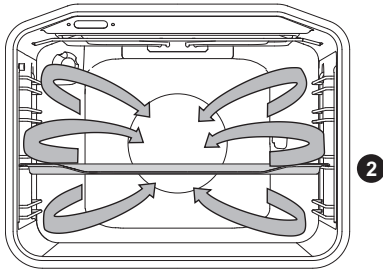

Round heater and the fan will operate. The fan installed in the back wall of the oven cavity, makes sure that hot air constantly circulates around the roast or pastry.

### Roasting meat:

Use enamel coated, tempered glass, clay, or cast iron pan or tray. Stainless steel trays are not suitable as they strongly reflect the heat.

Provide enough liquid during the cooking process to prevent the meat from burning. Turn the meat during roasting. The roast will remain juicier if you cover it.

Type of food	Weight (g)	Guide (from the bottom)	Temperature (°C)	Cooking time (minutes)
<b>MEAT</b>				
Pork roast, including skin	1500	2	170-180	140-160
Duck	2000	2	160-170	120-150
Goose	4000	2	150-160	180-200
Turkey	5000	2	150-170	180-220
Chicken breast	1000	3	180-200	60-70
Stuffed chicken	1500	2	170-180	90-110

### Baking pastry:

Preheating is recommended.

Biscuits and cookies can be baked in shallow baking sheets on several levels simultaneously (2nd and 3rd).

Note that baking time can differ even the same baking sheets are used.. The biscuits in the upper baking sheet may be done sooner than those in the lower one.

For even browning, make sure the biscuits are of the same thickness.

Always place the baking trays on the grid. If you are using the supplied baking sheet, remove the grid.

Type of food	Guide (from the bottom)	Temperature (°C)	Cooking time (minutes)
<b>PASTRY</b>			
Sponge cake	2	150-160	25-35
Crumble cake	2	160-170	25-35
Fruit cake, sponge	2	150-160	45-65
Sponge roll*	2	160-170	15-25
Fruit cake, short crust	2	160-170	50-70
Apple strudel	2	170-180	40-60
Biscuits, short crust*	2	150-160	15-25
Biscuits, pressed*	2	140-150	15-25
Cookies, leavened	2	170-180	20-35
Cookies, phyllo dough	2	170-180	20-30
<b>PASTRY - FROZEN</b>			
Apple and cottage cheese strudel	2	170-180	50-70
Pizza	2	170-180	20-30
Fried potatoes, oven-ready	2	170-180	20-35
Croquettes, oven-baked	2	170-180	20-35

The symbol \* means that the oven should be preheated using the selected cooking system.



**Do not insert the deep baking tray into the first guide.**



## BOTTOM HEATER AND FAN

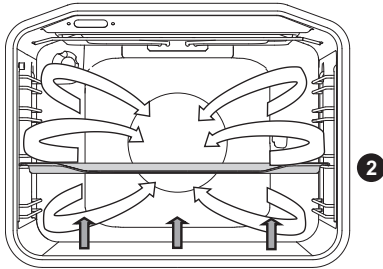

This is used for baking leavened but low-rising pastry and for preserving fruit and vegetables. Use the second guide from the bottom and a rather shallow baking tray to allow the hot air to circulate across the upper side of the dish.

### Preservation:

Prepare the food to be preserved and jars as usual. Use jars with a rubber sealing ring and a glass cover. Do not use jars with threaded or metal caps or metal tins. Make sure the jars are of equal size, filled with the same contents, and tightly sealed.

Pour 1 litre of hot water into the deep tray (approx. 70°C) and place 6 1-litre jars into the tray. Place the tray into the oven on the second guide.

During preservation, observe the food and cook until the liquid in the jars starts to simmer – when bubbles appear in the first jar.

Type of food	Guide (from the bottom)	Temperature (°C)	Time to simmer (min)	Temperature and time after the start of simmer	Resting time in the oven (min)
<b>FRUIT</b>					
Strawberries	2	160-180	30-45	/	20-30
Stone fruits	2	160-180	30-45	/	20-30
Fruit mush	2	160-180	30-45	/	20-30
<b>VEGETABLES</b>					
Pickled gherkins	2	160-180	30-45	/	20-30
Beans/carrots	2	160-180	30-45	120°C, 45-60 min	20-30

## TOP AND BOTTOM HEATER WITH FAN

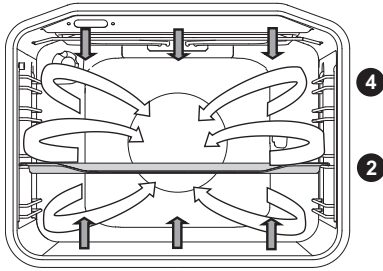

This function is used for baking of all types of pastry, for defrosting and for drying fruits and vegetables. Before placing the food into the preheated oven, wait for the light to go off for the first time. For best results, bake only on one shelf (level).

The oven should be preheated. Use the 2nd or the 4th, counting from the bottom up.

**Table for baking pastry with upper and lower heater and the fan**

Type of pastry	Guide level (from the bottom)	Temperature (°C)	Cooking time (minutes)
Marble cake	2	140-150	45-55
Cake in a rectangular baking sheet	2	130-140	45-55
Cheesecake	2	130-140	55-65
Fruit cake - shortcrust	2	140-150	35-45
Sponge cake	2	140-150	25-35
Fruit cake, sponge	2	130-140	35-45
Sponge roll	2	140-150	15-25
Christmas loaf	2	130-140	50-60
Jelly-filled rolls (Buchtel)	2	150-160	25-35
Gugelhupf (Bundt cake)	2	130-140	40-50
Shortcrust biscuits	2	140-150	15-25
Pressed cookies *	2	130-140	10-15
Small pastries, leavened dough	2	140-150	15-20
Bread*	2	170-180	45-55
Quiche Lorraine	2	150-160	35-45
Apple strudel	2	150-160	40-50
Pizza*	2	180-190	10-20
Phyllo pastry	2	150-160	18-25

The symbol \* means that the oven should be preheated using the selected cooking system.

# GENTLEBAKE

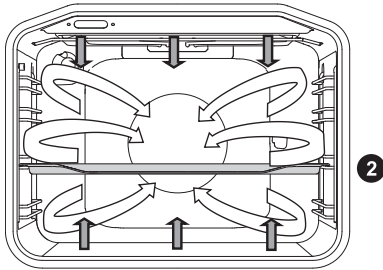

This feature allows gentle, slow, and even baking that leaves the food soft and juicy. It is suitable for roasting meat, cooking fish, and baking pastry on a single rack.

Type of food	Guide (from the bottom)	Temperature (°C)	Cooking time (minutes)
<b>MEAT</b>			
Pork roast, 1 kg	2	190	90 - 120
Beef roast, 1 kg	2	190	100-130
Beef tenderloin, 200 g/piece	2	180	40-50
Chicken, 1,5 kg	2	210	100 - 120
Chicken breast, fillet, 200 g/piece	2	200	45 - 60
Veal roast, 1 kg	2	180	95 - 120
<b>FISH</b>			
Whole fish, 200 g/piece	2	190	35 - 45
Fish fillet, 100 g/piece	2	190	25 - 35
<b>PASTRY</b>			
Shortcrust biscuits	2	150	25-40
Piped cookies	2	150	35-50
Small cupcakes	2	170	35-50
Sponge roll	2	170	40-55
Fruit cake, shortcrust	2	170	65-85

(Applies to appliances with pull-out or wire rails, without the hot air system )

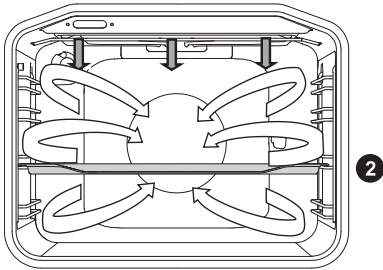

Type of food	Weight (g)	Guide level (from the bottom)	Temperature (°C)	Cooking time (min)
<b>MEAT</b>				
Duck	2000	2	150	90-110
Pork roast	1500	2	160	80-100
Pork shoulder	1500	2	150	130-160
Pork shank	1000	2	150	130-150
Half of chicken	700	2	190	60-70
Chicken	1500	2	190	80-100
<b>FISH</b>				
Trout	200 g/piece	2	200	20-30



## DEFROSTING

In this mode, the air will circulate without any heaters operating.

Food suitable for defrosting includes cakes with heavy cream or butter-based cream, cakes and pastry bread and rolls, and deep-frozen fruits.

In most cases, it is recommended to remove the food from the packaging (do not forget to remove any metal clamps or clips).

Halfway through the defrost time, the pieces should be turned over, stirred and separated if they are frozen together.

## PLATE WARMER



Use this function to reheat your dinnerware (plates, cups) before serving food to keep the food warm longer.

## AQUA CLEAN



Only the bottom heater will radiate heat. Use this function to remove stains and food residues from the oven. The program takes 30 minutes. More detail in chapter MAINTENANCE & CLEANING.

# MAINTENANCE & CLEANING

---



Be sure to unplug the appliance from the power supply and wait for the appliance to cool down.

Children should not clean the appliance or perform maintenance tasks without proper supervision.

## Aluminium finish

Clean the aluminium finish with non-abrasive liquid cleaners intended for such surfaces. Apply the cleaner onto a wet cloth and clean the surface. Then, rinse the surface with water. Do not apply the cleaner directly onto the aluminium finish.

Do not use abrasive cleaners or sponges.

Note: The surface should not come into contact with oven cleaning sprays as this may result in visible and permanent damage.

## Stainless steel sheet front side of the housing

(depending on the model)

Clean this surface only with a mild detergent (soapsuds) and a soft sponge that will not scratch the finish. Do not use abrasive cleaners or cleaners containing solvents as they may damage the housing finish.

## Lacquer-coated surfaces and plastic parts

(depending on the model)

Do not clean the knobs and buttons, door handles, stickers, and rating/type plates with abrasive cleaners or abrasive cleaning materials, alcohol-based cleaners, or with alcohol. Immediately remove any stains with a soft non-abrasive cloth and some water, in order to avoid damaging the surface.

You may also use cleaners and cleaning materials intended for such surfaces as instructed by their respective manufacturers.



The aluminium-coated surfaces should not come into contact with oven cleaning sprays as this may result in visible and permanent damage.

# CLEANING THE COOKING HOBS

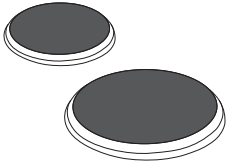

Clean the area around the cooking zones with hot water and some washing-up liquid.

For stubborn dirt, use a steel wool pad soaked with detergent; then, rinse the hob and wipe it dry.

Liquids containing salt, boiled-over liquids and moisture have detrimental effect on the cooking zones. Always clean the cooking zones,

Use regular cleaners and commercially available conditioners to maintain the cooking zones. If the cooking zone is slightly warm, the cleaner will penetrate the pores more readily.

Cooking zone rings are made of stainless steel. Because exposure to heat, they may take on a yellowish hue after a certain period of use. This is a normal physical phenomenon. The yellowish spots may be removed with regular metal cleaners. Aggressive dishwashing accessories are not suitable for cleaning of these rims, as they may cause scratches.

# CONVENTIONAL OVEN CLEANING

You may use the standard cleaning procedure to clean stubborn dirt in the oven (using cleaners or an oven spray). After such cleaning, rinse the cleaner residues thoroughly.

Clean the oven and the accessories after each use to prevent the dirt from burning into the surface. The easiest way to remove fat is by using warm soapsuds while the oven is still warm.

With stubborn dirt and grime, use conventional oven cleaners. Rinse the oven thoroughly with clean water to remove all cleaner residue.

Never use aggressive cleaners, abrasive cleaners, abrasive sponges, stain and rust removers etc.

Clean the accessories (baking sheets and trays, grids etc.) with hot water and detergent.

The oven, the oven cavity and the baking trays are lined with a special enamel coating for a smooth and resistant surface. This special coating makes cleaning at room temperature easier.

# CLEANING THE GLASS CERAMIC SURFACE

After each use, wait for the glass ceramic surface to cool down and clean it. Otherwise, all remaining impurities will burn onto the hot surface the next time you use the hob.

For regular maintenance of the glass ceramic hob, use special care products that create a protective film on the surface to prevent the dirt from sticking onto it.



Before each use of the glass ceramic surface, wipe off the dust or any other impurities that could scratch the surface, from both the hob and the pan bottom.



Steel wool, coarse cleaning sponges, and abrasive powders may scratch the surface. The surface may also be damaged by aggressive spray cleaners and unsuitable liquid cleaners.



Signage may be worn when using aggressive or abrasive cleaners or cookware with coarse or damaged bottom.

Use a damp soft cloth to remove minor impurities. Then, wipe the surface dry.

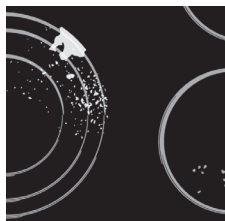

Remove water stains with a mild solution of vinegar. However, do not use this solution to wipe the frame (only with some models) as it may lose its sheen. Do not use aggressive spray cleaners or descaling agents.

Use special glass ceramic cleaners for stubborn dirt. Observe the manufacturer's instructions. Be sure to thoroughly remove any cleaner residues after the cleaning process as they may damage the glass ceramic surface when the cooking zones heat up.



Remove stubborn and burnt residues with a scraper. Be careful when handling the scraper to prevent injury.



Only use the scraper when dirt cannot be removed with a wet cloth or special cleaners for glass ceramic surfaces.

Hold the scraper at the correct angle (45° to 60°). Gently press the scraper against the glass and slide it over the signage to remove the dirt. Make sure the plastic handle of the scraper (in some models) does not come into contact with a hot cooking zone.



**Do not press the scraper perpendicularly against the glass and do not scratch the hob surface with its tip or blade.**



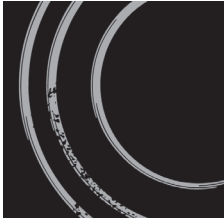

Immediately remove any sugar or sugar-laden food from the glass ceramic hob using a scraper, even if the hob is still hot, as sugar may permanently damage the glass ceramic surface.



Discolouration of the glass ceramic surface does not affect the operation or stability of the surface. Such discolouration is most commonly a result of food residues burnt onto the surface, or it may be caused by some cookware materials (such as aluminium or copper). Such discolouration is very difficult to remove entirely. Note: Discolouration and similar flaws only affect the appearance of the hob and do not directly affect its function. Removing such flaws shall not be covered by the warranty.

# USING THE AQUA CLEAN FUNCTION TO CLEAN THE OVEN

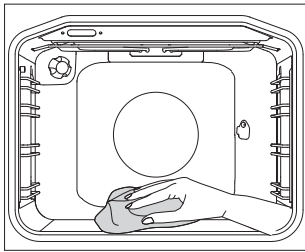
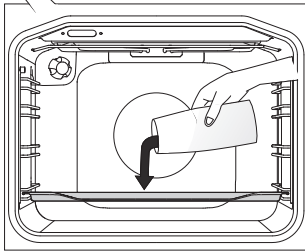
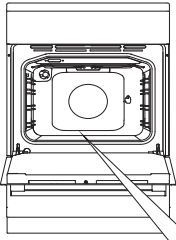

**1** Turn the COOKING SYSTEM SELECTOR KNOB to Aqua Clean. 2. Set the TEMPERATURE KNOB to 70 °C.

**2** Pour 0.6 l water into the glass tray and place it into the lower guide.

**3** After 30 minutes, food residues on the oven enamel walls will have softened and they will be easy to clean with a damp cloth.



Use the Aqua Clean system when the oven has fully cooled down..

# REMOVING AND CLEANING WIRE AND TELESCOPIC EXTENDIBLE GUIDES

Only use conventional cleaners to clean the guides.

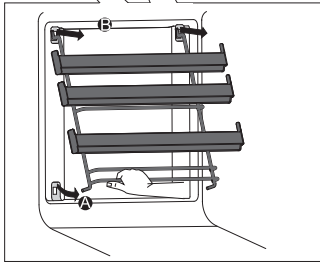
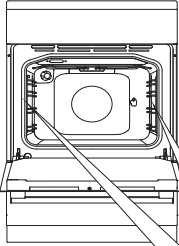

**A** Hold the guides by the bottom side and pull them towards the center of the oven cavity.

**B** Remove them from the openings at the top.

To replace the guides, observe the reverse order.

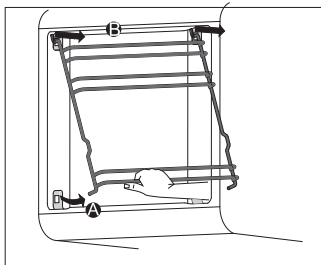

## **WARNING:**

Do not remove the clamps inserted in the oven.



**Do not clean the extendible guides in the dishwasher.**

# CLEANING AND INSTALLING THE CATALYTIC INSERTS

Only use conventional cleaners to clean the guides.

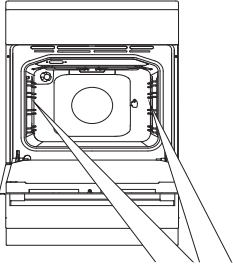

Remove the wire guides or extendible guides.

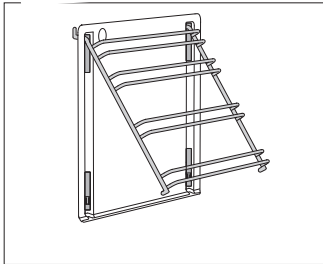

**1** Mount the guides onto the catalytic insert.

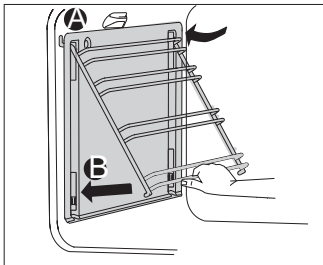

**2** Hang the inserts with guides attached using the holes provided, and pull upwards.

**A** Insert the guide rails into the opening at the top.

**B** Press them into the snap lock at the bottom.



Do not wash the catalytic inserts in the dishwasher.

# REMOVING AND INSERTING THE OVEN DOOR

(depending on the model)

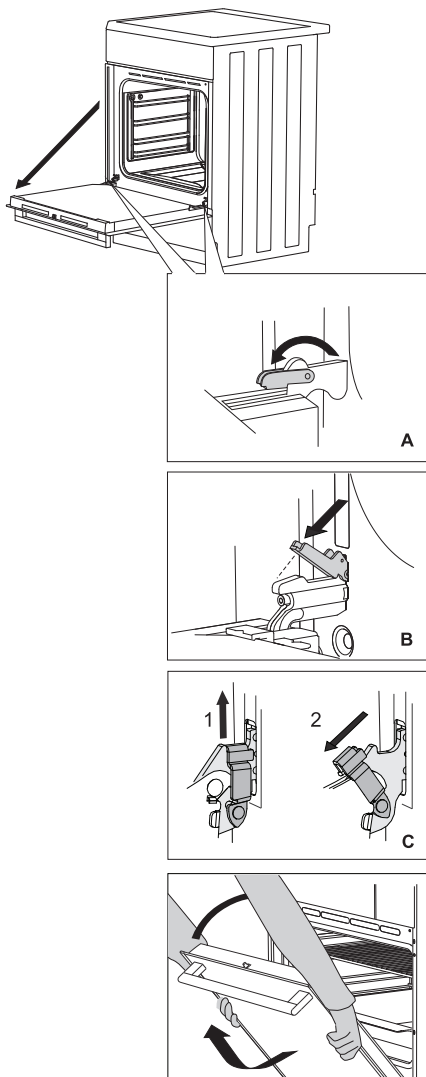

**1** First, fully open the door (as far as it will go).

**2** **A** Rotate the stoppers all the way back (in case of conventional closing).

**B** With soft closing system, rotate the stoppers back by 90°.

**C** If the appliance is fitted with the GentleClose system, slightly lift the door latches and pull them towards you.

**3** Slowly close the door until the latches are aligned with the slots. Slightly lift the door and pull it out from both hinge slots on the appliance.

To replace the door, follow the reverse order. If the door does not open or close properly, make sure the notches on the hinges are aligned with the hinge beds.



When replacing the door, always make sure the hinge retainers are correctly placed in the hinge beds to prevent sudden closing of the main spring which is connected to a strong main spring. If the main spring is engaged, there is a risk of injury.

## DOOR LOCK (depending on the model)

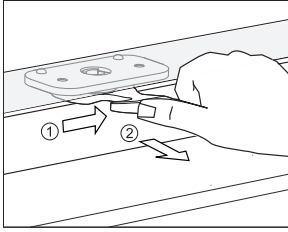

To open it, gently push it to the right with your thumb and pull the door outwards at the same time.

 **When the oven door is closed, the door lock automatically returns to the initial position.**

## DEACTIVATING AND ACTIVATING THE DOOR LOCK

 **The oven should be cooled down completely.**

First, open the oven door.

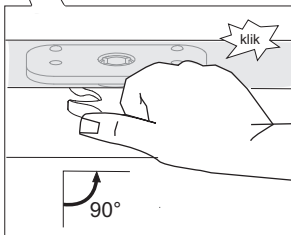
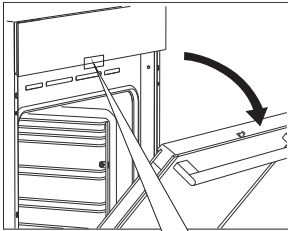

Push the door lock to the right by 90° with your thumb until you feel a click. The door lock is not deactivated.

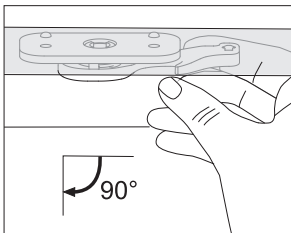

To reactivate the door lock, open the oven door and use your right-hand index finger to pull the lever towards you.

## **SOFT DOOR CLOSING** (depending on the model)

Oven door is fitted with a system that dampens the door closing force, starting at the 75-degree angle. It allows simple, quiet, and smooth closing of the door. A gentle push (to a 15-degree angle relative to the closed door position) is enough for the door to close automatically and softly.



**If the force applied to close the door is too strong, the effect of the system is reduced or the system will be bypassed for safety.**

# REMOVING AND INSERTING THE OVEN DOOR GLASS PANE

Oven door glass pane can be cleaned from the inside, but it has to be removed first. Remove the oven door (see chapter "Removing and replacing the oven door").

Depending on appliance model, the glass in the door is removed either as described in METHOD 1 or METHOD 2.

## METHOD 1 (depending on the model)

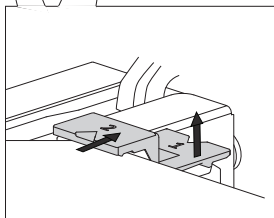
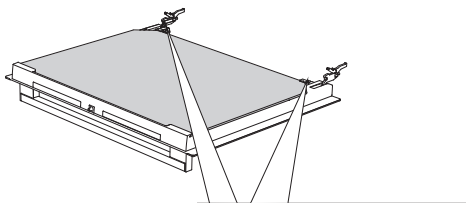

**1** Slightly lift the supports on the left and right side of the door (marking 1 on the support) and pull them away from the glass pane (marking 2 on the support).

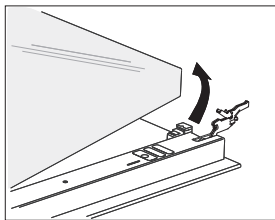

**2** Hold the door glass pane by the lower edge; slightly lift it so that it is no longer attached to the support; and remove it.

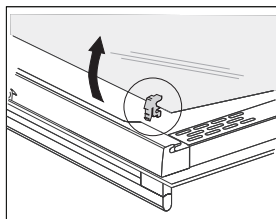

**3** To remove the third glass pane (only with some models), lift and remove it. Also remove the rubber seals on the glass pane.



To replace the glass pane, observe the reverse order. The markings (semicircle) on the door and the glass pane should overlap.



## METHOD 2 (depending on the model)

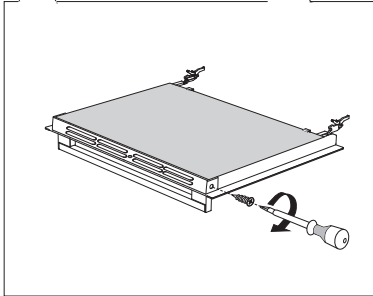
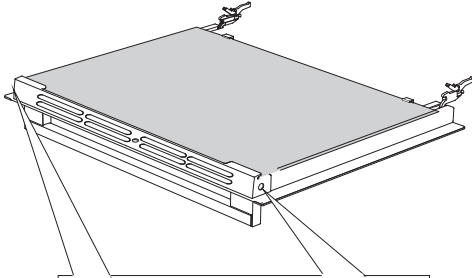

**1** Undo the holder screws on both sides of the door.

.....

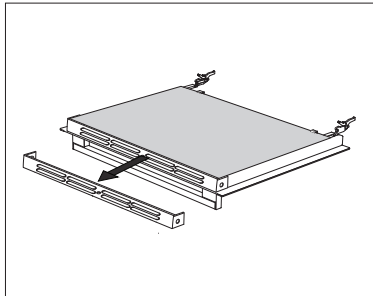

**2** Remove the holder.

.....

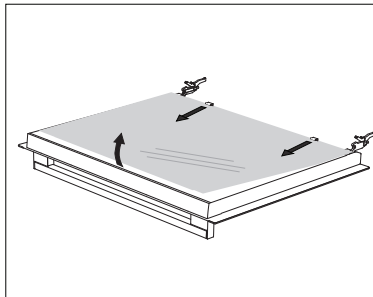

**3** Slightly lift the door glass and remove it from the clips on the bottom side of the door.

To replace the door glass, observe the reverse order.

# REPLACING THE BULB

The bulb is a consumable and therefore not covered by warranty. Before changing the bulb, remove the trays, the grid, and the guides.

Use a Phillips (cross) screwdriver.

(Halogen lamp: G9, 230 V, 25 W; regular bulb E14, 25 W, 230 V)

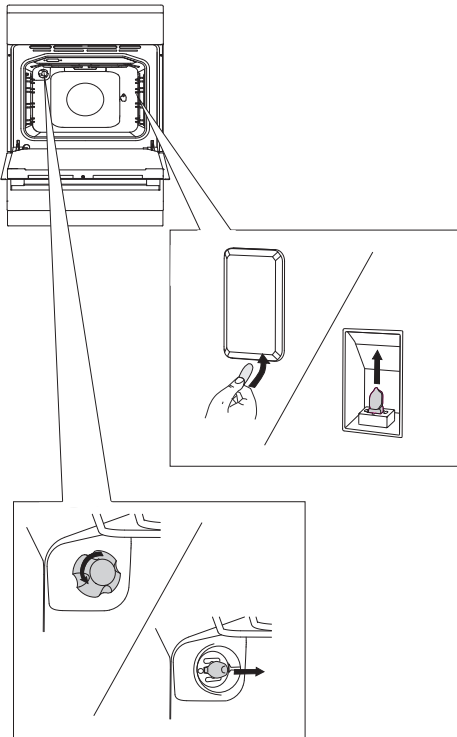

Use a flat screwdriver to release the bulb cover and remove it. Remove the bulb.

💡 Be careful not to damage the enamel.

Undo the bulb cover and remove the bulb.

💡 Use protection to avoid burns.

# SPECIAL WARNINGS AND FAULT REPORTING

---

**During the warranty period, only a service center authorized by the manufacturer may carry out any repairs.**

Before making any repairs, make sure the appliance is disconnected from the power mains either by removing the fuse or by disconnecting the power plug from the wall outlet.

Unauthorized tampering with and repairs of the kitchen range (cooking hob) can result in electric shock or short circuit; hence, do not attempt to perform any repairs by yourselves. Leave such tasks to an expert or an authorized service unit.

In case of minor faults or problems with the appliance operation, check the following instructions to see whether you can eliminate the causes by yourselves.

## IMPORTANT

A visit by a service technician during the warranty period will be charged if the appliance is not functioning because of improper use. Store these instructions in a place where they are always readily accessible; if you pass the appliance on to another person, the instructions should also be included.

Following is some advice on rectifying some common problems.

<b>Problem/error</b>	<b>Cause</b>
<b>There is no response of the sensors; the display is frozen.</b>	Disconnect the appliance from the power mains for a few minutes (undo the fuse or switch off the main switch); then, reconnect the appliance and switch it on.
<b>The main fuse in your home trips often.</b>	Call a service technician.
<b>The oven lighting does not work.</b>	The process of changing the light bulb is described in the chapter Cleaning and Maintenance.
<b>The pastry is underdone.</b>	Did you choose the right temperature and heating system? Is the oven door closed?
<b>An error code is displayed (E1, E2, E3 etc.).</b>	There is an error in the electronic module operation. Disconnect the appliance from the power mains for a few minutes. Then, reconnect it and set the time of day. If the error is still indicated, call a service technician.

If the problems persist despite observing the advice above, call an authorized service technician. Repair or any warranty claim resulting from incorrect connection or use of the appliance shall not be covered by the warranty. In this case, the user will cover the cost of repair.

# INSTALLATION AND CONNECTION INSTRUCTIONS

## APPLIANCE PLACEMENT

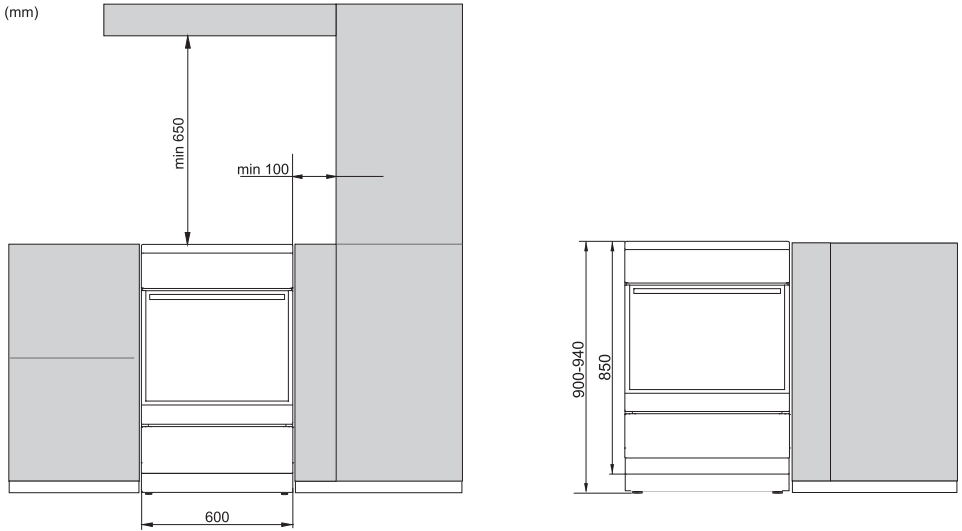

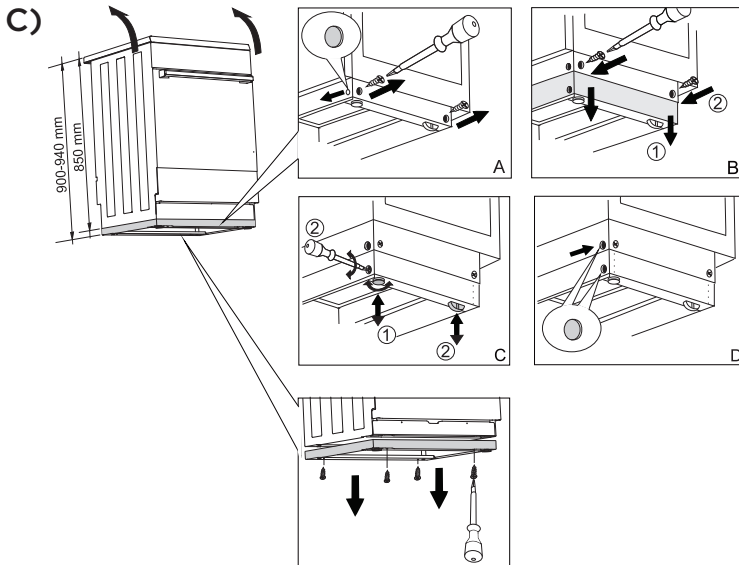
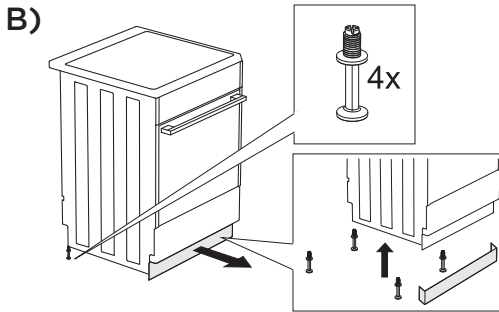
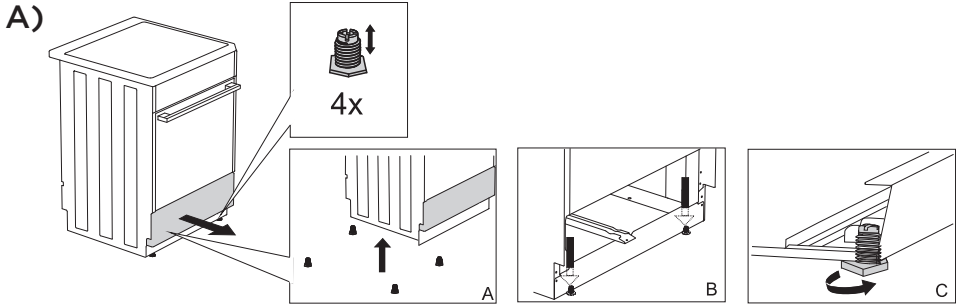

The walls or furniture adjacent to the appliance (floor, rear kitchen wall, side walls) have to be temperature-resistant to at least 90 °C.

# LEVELLING THE APPLIANCE AND ADDITIONAL SUPPORT

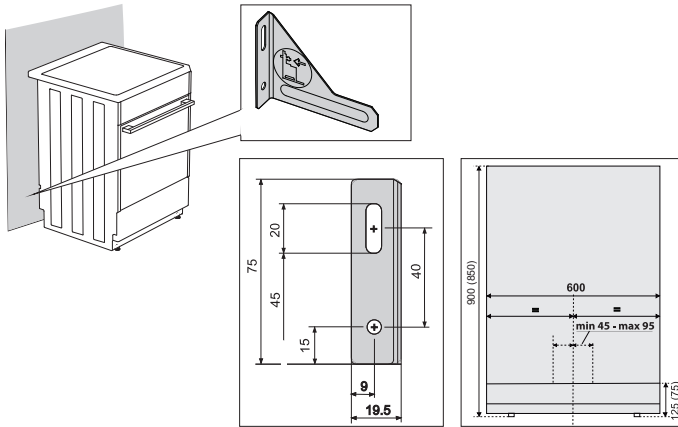

## PREVENTION FROM TIPPING OVER



 Dimensions in the parenthesis represent built-in measures of the support bracket without the additional support. If the supplied element protecting the appliance from tipping over cannot be firmly secured to your wall with the screws and the wall plugs supplied, use other fittings to secure the bracket in such way that it cannot be pulled out from the wall.

## CONNECTING TO THE POWER MAINS

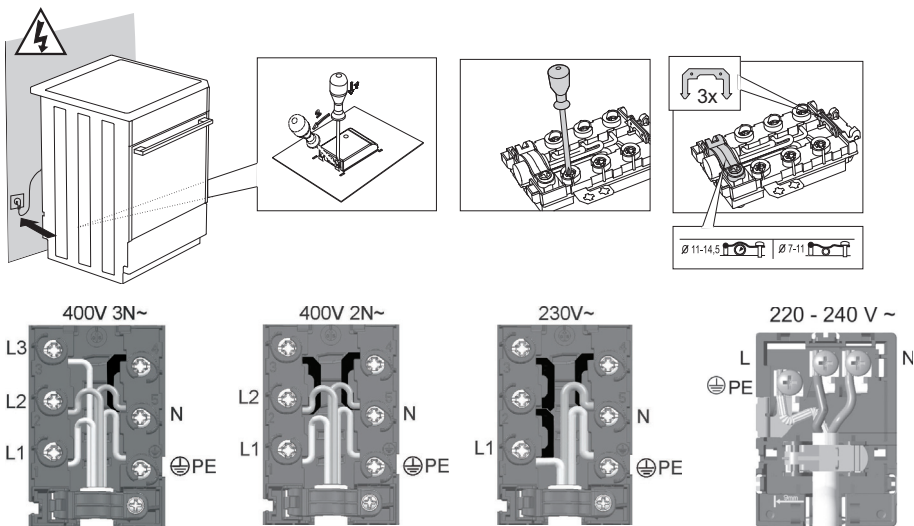

The supplied cap must be placed over the connecting clip!

# DISPOSAL

---



Packaging is made of environmentally friendly materials that can be recycled, disposed of, or destroyed without any hazard to the environment. To this end, packaging materials are labelled appropriately.

The symbol on the product or its packaging indicates that the product should not be treated as normal household waste. The product should be taken to an authorized collection center for waste electric and electronic equipment processing.

Correct disposal of the product will help prevent any negative effects on the environment and health of people which could occur in case of incorrect product removal. For detailed information on removal and processing of the product, please contact the relevant municipal body in charge of waste management, your waste disposal service, or the store where you bought the product.

*We reserve the right to any changes and errors in the instructions for use.*

E\_GUS\_SVK



en (03-22)