

EN

**DETAILED
INSTRUCTIONS FOR
USE OF
INDUCTION HOB**

gorenje

BY

STARCK®

Dear customer,

You have purchased a product of our new series of appliances. We hope that our product will serve you well and for a long time.

Read this manual before installation and use of this appliance. It contains important information concerning how safely and economically operate the appliance. Save the manual together with the appliance for an eventual further use.

You can find this manual for use also on the web site:

[www.gorenje.com / <http://www.gorenje.com/>](http://www.gorenje.com/)



Important information



Tips, remarks

CONTENT

<p>4 IMPORTANT INFORMATION, INSTRUCTIONS AND RECOMMENDATIONS</p> <p>8 DESCRIPTION AND OPERATION OF APPLIANCE</p>	<p>INTRODUCTION AND DESCRIPTION</p>
<p>11 THE OPERATION OF APPLIANCE</p> <p>18 ERROR MESSAGES</p> <p>19 THE PRINCIPLES OF USE OF INDUCTION HOB</p>	<p>OPERATION</p>
<p>20 CLEANING AND MAINTENANCE</p> <p>21 CLAIMS</p> <p>22 METHOD OF USE AND LIQUIDATION OF PACKAGING</p> <p>23 LIQUIDATION OF APPLIANCE AFTER FINISHING OF USE</p>	<p>MAINTENANCE AND RECLAMATION</p>
<p>24 INSTRUCTIONS FOR INSTALLATION</p> <p>28 THE CONNECTION OF APPLIANCE TO THE POWER MAINS</p>	<p>INSTALLATION</p>
<p>30 TECHNICAL DATA</p> <p>31 PRODUCT INFORMATION REGULATION (EU) NO 66/2014</p>	<p>TECHNICAL DATA</p>

IMPORTANT INFORMATION, INSTRUCTIONS AND RECOMMENDATIONS



SAFETY MEASURES

This appliance can be used with children older than 8 years and persons with decreased physical or mental ability or lack of experience and knowledge only in cases, when they are under supervision or when they were introduced to the use of appliance and they understand the possible dangers. The children should not play with this appliance. The user cleaning and maintenance can be not provided with children without inspection.

WARNING: Danger of fire: do not lay down objects on the cooking surfaces.

WARNING: The cooking without supervision with fat or oil on the cooking surface could be dangerous and could cause the ignition of fire. NEVER extinguish the fire here with water, but switch out the appliance first and then cover the flames for instance with pot lid or with a wet cloth.

REMARK: The cooking process should be provided under supervision. Also a short time cooking should be provided under constant supervision.

Switch out the cooking element after use with the corresponding control device; do not rely on the pot detector.

Do not lay down any metal objects on the induction cooking surface, as forks, spoons and lids, as they could be heated up.

WARNING: If the induction hob surface shows cracks, switch out the appliance and the circuit breaker for to prevent the electric shock.

Never use steam or pressure cleaners for cleaning of the appliance. A danger of electric shock is threatening here.

The appliance is not adapted for control with help of external timers or other special control devices.

WARNING: Use the protection of cooking panel designed with the producer of cooking appliance or marked with the appliance producer as suitable in the user's manual only, or protection devices directly built in in the appliance. The use of incorrect protection devices could cause accident.

CAUTION

Only authorized service worker or similar authorized person can connect the appliance to the electric mains.

Manipulation with the appliance or unprofessional service could lead to risk of serious injury or to damaging of appliance, eventually. The installation, the all repairs, modifications or interventions into the appliance should be provided with the authorized serviceman or similarly authorized person only.

A device for disconnecting of all poles of the appliance from the mains into the electric wall circuit before the appliance should be inserted, where the contacts distance in disconnected state is 3 mm as minimum (thereafter called in the text as mains switch).

The cooking plate must be connected to the main with correct voltage, indicated on the rating plate and with help of supply line corresponding to the power consumption of induction hob (see „Connection of appliance to the electrical net“).

Please let confirm the date of provided installing in the Guarantee sheet.

The appliance is designed exclusively for cooking. Do not use for other purposes, for instance for room heating. Do not put empty pots on the cooking zones.

The electric feeding cables of the appliance or other appliances should not come in contact with the induction hob. Switch off the mains switch before providing cleaning or repairs.

Do not use the glass-ceramic surface as a shelf. Cracks or other damaging of surface can be caused so. Do not heat up food covered with aluminum foil, plastic pots or similar materials.

The danger of melting, fire or the damaging of induction hob threatens in such cases.

If the induction hob is out of operation, see that all its control elements are off.

The main power switch should be always switched off in case of changed surrounding conditions in the room with the installed appliance (painting, gluing works, etc.).

Switch off the main switch before the line connector at manipulation with the appliance or at longer time without use.

We recommend you to call once in two years the service company for checking of the induction hob functions. You can prevent this way the faults and prolong the lifetime of induction hob.



The symbol on the product or on its packaging determines, that this appliance should not be given into the domestic waste. It should be delivered to a collection spot for recycling of electric and electronic appliances. You can help to prevent the negative influences to environment and human health (which could be caused with inappropriate liquidation) with correct liquidation of this appliance. More detailed information on recycling of this product you can receive at competent local authority, service for liquidation of domestic waste or in the shop, where you had bought the product.

THE PURPOSE OF THE APPLIANCE

The appliance is designed for usual preparation of food in households and it should not be used for other purposes.

The individual possibilities of its use are fully described in this manual.



When using induction hob, DO NOT INSERT any additional equipment (for instance so called reduction rings or induction base, which make cookware with nonmagnetic base possible to use) between base of cookware and surface of hob. Application of such an equipment can cause damage of appliance and there is high risk of burning.

DESCRIPTION AND OPERATION OF APPLIANCE

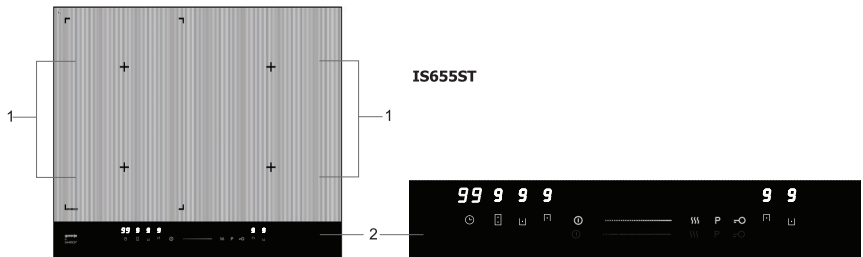
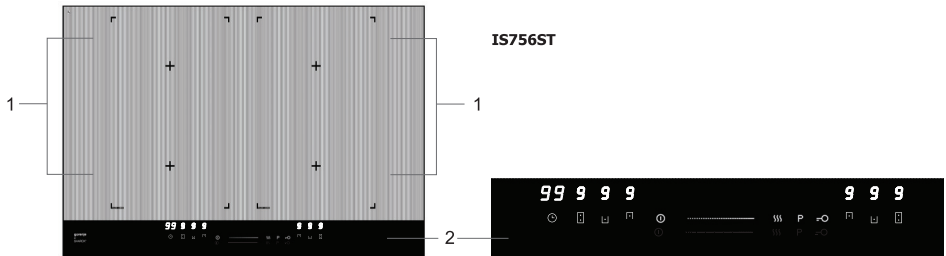

1. Cooking zones
2. Control panel – TOUCH CONTROL

The appliance is intended for building in a cutout in working table of kitchen furniture. The sealing rubber glued on the border of induction hob prevents the in-leak of liquids under the induction hob .

The basic part of appliance is the glass ceramics induction hob , to which all other supporting, covering and electric parts are connected.

The surfaces of hot plates are derived from usual dimensions of pots.

We do not recommend the use of pots exceeding the marking of cooking zone.

The overheating of induction electronics is prevented with a temperature limiter.

An increased temperature of induction hob surface after switching off is signaled with light indicator of residual heat.

The light indicator switches off after cooling down to a temperature without danger of burning.

USUAL NOISE DURING OPERATION OF AN APPLIANCE WITH INDUCTION WARMING

The appliance can emit noises as buzzing, whistling or cracking at switching on to maximum capacity or at certain utensils. These noises vanish after switching to lower capacity level. Also the quantity of cooked food and the method of cooking can affect the noise intensity.

The appliance is provided with a cooling ventilator, which is switched on at detected higher temperature. If the temperature is always high then the ventilator could remain running also after switching off of cooking zones.

The mentioned noises are usual manifestation of induction heating and they do not indicate a defect.

THE UTENSILS FOR INDUCTION COOKING ZONE

The magnetism is used for heat generation at induction cooking. Therefore the utensils have to contain iron. Check it please with a piece of magnet, whether the utensil is magnetic. The bottom of a pot used for induction cooking zones can have a smaller or the same diameter as the surface of marked cooking zone, within the range of:
from \varnothing 140 to \varnothing 200 mm - for individual zones,
from \varnothing 200 to 200 x 400 mm - for flex zones.

The other requirements for pots - see „The principles of using of glass ceramics plate“.

THE OPERATION OF APPLIANCE



Solely adults can operate this appliance and according to this manual.

It is not allowed to leave small children without supervision near the appliance in operation.

The electric induction hob is an appliance whose operation requires supervision.

Persons with pacemakers or insulin pumps can operate the appliance with induction cooking zones when their implants correspond with the 89/336/CEE regulation only.

THE CONTROL PANEL

IS756ST

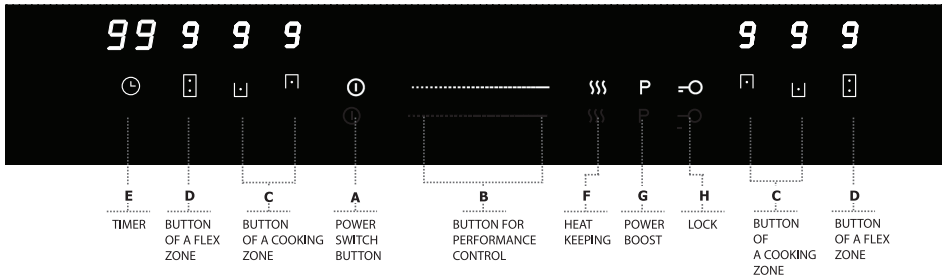

IS655ST

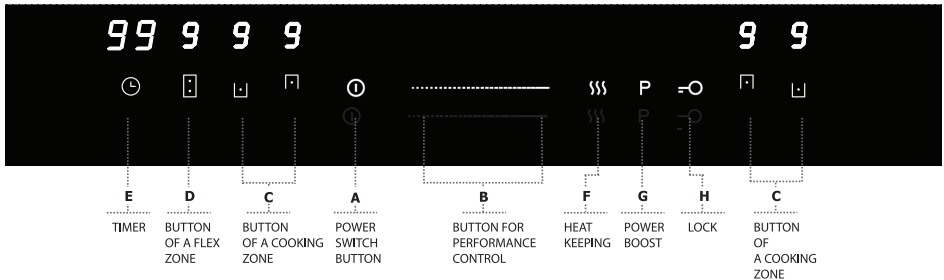

CAUTION

The sensor control is activated by touching a finger to appropriate symbol on glass ceramic hob. Therefore keep the control panel clean and dry.

Do not put objects on the induction hob control panel.

Do not allow the using or cleaning of plate's cooking surface by children.

Prevent all unwished switching on of the appliance, for instance with pets!

The set up parameters will be deleted after disconnection of induction hob form the power net.

Never lay down food packaged into aluminum foil, knives and forks, pot lids or other metal objects on the induction cooking zones. These objects could be heated up very quickly and cause burning or damages at unwished or unintentional switching on of appliance. After removing of the pot from cooking zones, the hob will be switched off in 60 seconds automatically.

Switch off the induction zone with the corresponding switch after using it; do not rely up to automatic switching off (pot recognition).

The input power of cooking zones is regulated within the range of 9 levels which are infinitely selectable by means of the "B" sensor on the control panel.

THE INDUCTION HOB SWITCHING ON



Press the A sensor (line switch). Symbols of control displays C, D and E will light up. If you would not provide a following selection up to 60 seconds, the induction hob would be switched off automatically.

THE COOKING ZONE SWITCHING ON

Choose the appropriate cooking zone or flexi-zone by pressing the C or D sensor.

Set the required performance level (1-9) with help of B sensor within 5 seconds after switching on the induction hob .

THE POT RECOGNITION ON THE INDUCTION COOKING ZONE



If the cooking zone is switched on but there is no pot or the pot is not suitable for induction cooking, no heat is transferred. Symbol "4" is flashing.

If there is a suitable pot on the cooking zone, the set power level is switched on and the number of power level is displayed. The heat transfer is interrupted when the pot is removed. Symbol "4" is flashing.

When a small pot is placed on cooking zone, the dimension of which is not less as the minimal diameter necessary for putting the induction hob into operation, then only an appropriate amount of heat, corresponding to the dimension of the pot will be transferred.

BRIDGE MODE (FLEXI-ZONE)

The cooking zones on the left as well as right side can be used as separate cooking zones (front and back ones) or united into the bridge mode of 200x400 mm (the type IS756ST only).

The cooking zones on the left side for the type IS655ST can be used independently (the front or the rear) or united in to the s.c. "bridge mode"; the cooking zones on the right side can be used separately only.

To activate the bridge mode, push the D sensor.

Now you can move the pot (\varnothing 200) from the front to back cooking zone (or vice versa), the bridge mode detects automatically its position and sets the performance for the appropriate zone.

To transfer the performance correctly, the pot (diameter 200) has to be placed in the front or back part of zone when using the bridge mode.

It is also possible to use an oval pot up to the size of 200x400 mm.

The oval pot can be placed anywhere on the entire zone surface when using the bridge mode.

THE INDICATION OF RESIDUAL HEAT



Right after switching off the cooking zone display shows "H" that means cooking zone temperature is above 60°C. After cooling down "H" will disappear.

This signalization prevents you from burning at switched off zone. The energy of hot cooking zone can be used so.

THE CHILD LOCK

The child lock prevents making changes of the setting during cooking or using the appliance.

METHOD

Turn on the hot plate by pushing the A sensor.. The child lock will be activated when pushing the H sensor. "Lo" appears on the display above the E sensor. You can activate the child lock also if any hot plate is active.

THE DEACTIVATION

Push and keep pushing the H sensor for c. 3 seconds.

"Lo" letters disappear and the hot plate is ready for use.

THE INDUCTION HOB SWITCHING OFF

Switching off the hob function can be done regardless the working state of the hob by touching “A” symbol.

If the induction hob is switched off then a sound beeps and all the symbols are switched off (except when the residual heat is signaled on some display).

THE FUNCTION OF INCREASED CAPACITY „POWER BOOST“

The „POWER BOOST“ function is for quick and maximal heat transfer through the corresponding cooking zone.

The cooking zone operates in this mode for 5 minutes as maximum. After elapsing of this period the capacity will be automatically decreased to the level 9.

When at using of „POWER BOOST“ function also the second induction zone on the same side of the hot plate is switched on, then the capacity level of this zone will be decreased to the level „2“.



All cooking zones are provided with the „POWER BOOST“ function.

THE ACTIVATION OF THE “POWER BOOST” FUNCTION

Set any performance level for the cooking zone.

Press the G sensor to activate the “POWER BOOST” function.

The “b” letter will be displayed on the display of appropriate zone during activation of this function.

THE DEACTIVATION OF THE “POWER BOOST” FUNCTION

The “POWER BOOST” function will be deactivated when choosing any level on the B sensor.

KEEP WARM FUNCTION

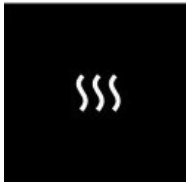

Low performance keeps food hot.
This function can be used for all cooking zones.

THE ACTIVATION OF THE “KEEP WARM FUNCTION”

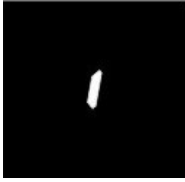

Turn on the hot plate by pushing the A sensor. Choose the appropriate cooking zone or flexi-zone by pressing the C or D sensor. Activate the function of keeping food hot by pushing the F sensor. “F” symbol appears on the display of a hot plate.

THE DEACTIVATION OF THE “KEEP WARM FUNCTION”

Choose the appropriate cooking zone or flexi zone, where this function is activated, by pushing the C or D sensor. The deactivation of the function can be done with the sensor „B“.

IS756ST

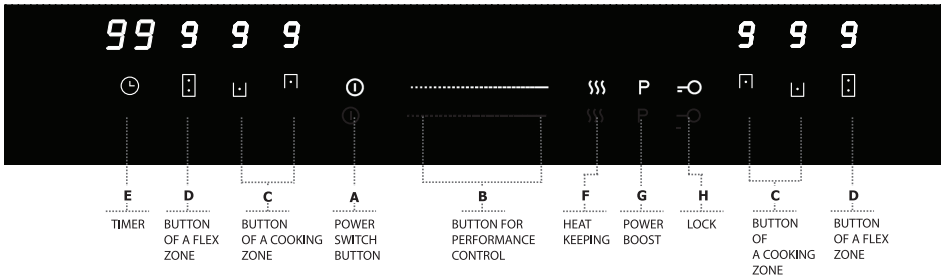

IS655ST

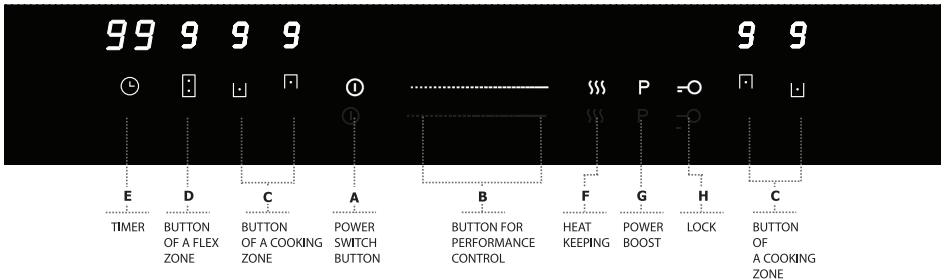

TIMER

The induction hob is provided with a timer, which can work in two modes:

- a) minute reminder
- b) time control of cooking zone (the setting up of time interval for operation of cooking zone)

STOPWATCH

The timer is in stopwatch working mode.

A sound signal sounds after finishing of operation.

The stopwatch function can be used at switched on state of built-in hotplate only, and at least one cooking zone must be active in the same time.

METHOD

Turn on the induction hob by pressing the A sensor.

Choose the appropriate cooking zone by pressing the C or D sensor.

Set the required performance level (1 - 9) by pushing the B sensor.

Wait more than 5 seconds, until the sensor for cooking zone selection will be inactive.

Press than the E sensor of the timer.

The sign 10 appears on the display above the sensor.

Set the required number of minutes using the B sensor.

You can set time for tens of minutes when pushing repeatedly the E timer sensor and using the B sensor.

After the set time ends, the display shows the value of "00" and the audio signal sounds for 30 seconds.

The operation of active cooking zone is not affected with the stopwatch function.

THE TIMING OF COOKING ZONE

The mode for timing of cooking zone serves for finishing of cooking zone operation after elapsing of set up time. A sound signal sounds after finishing of operation.

The function for cooking zone timing can be activated at switched on state of built-in induction hob and at activated cooking zone (level 1 - 9) only.

METHOD

Turn on the built-in plate by pushing the A sensor.

Choose the appropriate cooking zone by pressing the C or D sensor.

Set the required performance level (1 - 9) by pushing the B sensor.

Push the E timer sensor within 5 seconds and set the required time by pushing the B slider.

An acoustic signal sounds after expiration of time set and the cooking zone switches off.



The mode for timing of cooking zone can be used for all cooking zones simultaneously. You can set off-time for other cooking zone when turning on another cooking zone by pushing the C or D sensor and by consecutive pushing of the E timer sensor.

Time remaining till turning-off a cooking zone is displayed on the display. The displayed time belongs to the cooking zone which has a flashing decimal point next to the displayed performance level.

Luminous decimal points at other figures of performance levels symbolize the set off-time for a concrete zone.

To clear the set timing of a cooking zone push the E sensor and then keep pushing it for c. 2 seconds.Examples of activities at setting on of capacity levels.

Examples of activities at setting on of power levels	
Level 0	Switched off
Level 1 - 3	For holding off liquids in light boiling, For light and slow heating up without danger of burning, For solution of butter, chocolate, For de-freezing, For boiling of small quantity of liquid.
Level 4 - 6	For intensive boiling, For keeping in boiling of greater volume of liquid, For stewing.
Level 7 - 9	For preparation of food, requiring fast heating and high temperature (beefsteaks, slices, chipped potatoes, etc.), For warming up of food before switching over to lower capacity level.

THE LIMITATION OF COOKING ZONE OPERATION TIME

The cooking zones have an automatic operation time limitation. The continuous use of each cooking zone depends on the selected heating level (see the table).

The condition is here, that no modification in cooking zone setting was realized during the use. At the moment of activation of operation limitation the cooking zone is switched off, a short sound signal sounds and the display shows the sign „H“.

The switching off automatics has priority before the limitation of operation time; that means that the cooking zone switches off after expiration of the time of automatics only (e.g. there is the switching off automatics with 99 minutes and with capacity level 9 possible).

POWER LEVEL	MAXIMAL TIME PERIOD (HOURS)
1	8
2	8
3	8
4	4
5	4
6	4
7	2
8	2
9	2
P	5 (minutes)

P - function of increased capacity "BOOSTER"

ERROR MESSAGES

(E and error code are flashing)

E1/E2 - UNSUITABLE SUPPLY VOLTAGE

The connection of an induction hob and supply voltage must be checked.

E3/E4/E5 - COOKING ZONE OVERHEATING

The cooking zone could be overheated for instance at leaving an empty pot on a switched on cooking zone and in similar cases. In this case let the hob cool down.



In case of displaying of another code - refer to authorized service.

THE PRINCIPLES OF USE OF INDUCTION HOB

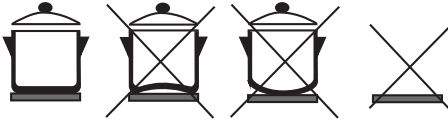

The induction hob fulfills at corresponding use according to these instructions the all requirements to similar home appliances. Switch off the main switch before the first use and clean the appliance orderly (for cleaning agents see the chapter "Cleaning and maintenance"). Remove the advertising

sticker from the appliance, which is located in the corner of the glass-ceramic plate. Solely adults can operate this appliance and according to this manual.

It is not allowed to leave small children without supervision near the appliance in operation. The electric induction hob is an appliance whose operation requires supervision. Prevent the use of empty enameled pots; their bottoms could be so damaged and at scratch the surface at moving on the cooking plate.

Pots with grooving or burrs on the bottom are not suitable.

The bottom of metal pots should be for achieving the best results (at cooking on induction cooking zone) 2 - 3 mm thick, at pots from stainless steel with sandwich bottom 4 - 6 mm thick.

The bottom should be at room temperature slightly bulged out, as after hot extension only will lay on the cooking zone surface evenly. The minimal thermal losses are so ensured with contact of surfaces.

You can prevent the scratching of glass ceramics with use of pots with clean and smooth bottom.

Use pots with a diameter corresponding in size to the diameter of selected cooking zone. The heat created on the pot bottom depends from the pot diameter. At smaller pot also the capacity is lower. There is no exceeding consumption of energy, when the cooking zone is not fully covered by the pot. Nevertheless put the pot in the middle of cooking zone.

Use higher capacity levels for bringing food to boiling. Switch over to lower capacity level of cooking zone after achieving of boiling.

Never use trays from aluminum foil nor made from aluminum containing materials.

Do not place things from plastics (spoons, trays, strainers, etc.) on the hot cooking zones, such materials can easily melt and burn up.

Overheated fats can easily inflame so be careful, when preparing meals on fats and oils (frying, etc.).



The changes in color and similar defects have impact to the appearance of the cooking plate only and never directly to its function. The removing of such defects is not subject of the warranty.

CLEANING AND MAINTENANCE

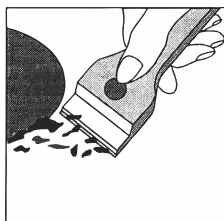
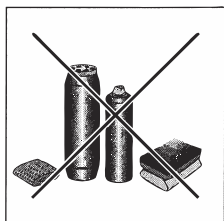

Your induction hob is a nice looking and easy to operate. The following hints and recommendations can help you keep it as it is for a long time.

RECOMMENDATIONS

Do not use steam cleaner for cleaning of the appliance!

Clean your glass ceramic plate regularly, after each use as the best.

Remove from the induction hob the all dried on food and liquid rests with help of a scraper (enclosed in accessory) first.

As soon as the plate is cold, apply a few drops of suitable detergent and clean the surface with paper towel or clean and soft towel.

Wash and dry up the surface after cleaning by another paper towel or soft cloth.

Never use steel wool, washing sponge or other cleaning matters with rough surface.

We do not recommend also the agents supporting corrosion, as for instance sprays for cleaning of roasters and for removing of stains.

When by mistake an object from plastic, kitchen foil, sugar of food containing sugar was melted on the hot surface of your glass ceramic plate, remove it immediately from the hot surface by the scraper, and this not only from the induction hob but also from the pot surface, when applicable. You prevent with it the damaging of cooking plate surface.

Before preparing meals with high content of sugar (for instance jam), coat the plate with suitable protective agent for to protect it against damaging it with sugar in case of running over of food or at pouring on the plate surface.

Shiny metal stains appear from scratching of aluminum pot bottom on the plate surface or with using of unsuitable cleaning agent. Removing such stains is hardly possible by repeated cleaning.

Colored changes on the induction hob surface are usually caused by not removed burnt on rests. They have no influence on the function of the glass ceramic plate.

You can cause **the grinding down of decor** with abrasive cleaning agents or with scratching of pot bottom on the induction hob surface for longer time. A dark stain can be created on the induction hob this way.

Any changes in a graphics glossy don't mean a damage of the appliance, but are the result of a normal use of the hob.

CLAIMS

If there is any defect on the appliance within the guarantee period, do not repair it self. Apply a claim in the shop in which you bought the appliance or at service representatives, mentioned in the Guarantee conditions. At applying of claim observe the text of Guarantee sheet and Guarantee conditions. The claim is valid with submitted dully filled up Guarantee sheet only.

METHOD OF USE AND LIQUIDATION OF PACKAGING

Packaging paper

- sale to waste collecting company
- to collecting vessels for used paper
- other reuse

The packaging foil and PE backs

- to collecting vessels for plastic

LIQUIDATION OF APPLIANCE AFTER FINISHING OF USE



This appliance is marked in accordance with Directive 2012/19/EC on manipulation with waste from electric and electronic equipment - WEEE.

This directive determines the unified European (EU) frame for collection and recycling of used equipment.

The appliance contains valuable materials which should be reused. Please give your used appliance to waste processing company or to by your community determined waste collection point.

INSTRUCTIONS FOR INSTALLATION

Solely company authorized to provide such activities may perform the installation of this induction hob and it should be installed in compliance with local standards and regulations.

At installation of appliance the following steps should be provided from point of view of appliance:

The checking of correct connection to electric power net,

The function check of heating, control and regulation elements,

The demonstration of appliance's all functions, operation and maintenance to the customer.

IMPORTANT NOTE!

 At any manipulation with the appliance, except of normal use, it is necessary to disconnect the power, e.g. with pulling out of the plug from the socket or with switching off the main switch before the appliance.



This appliance is not designed for operation with help of an external timer or with a separate system of remote control.

INSTALLATION DIMENSIONS

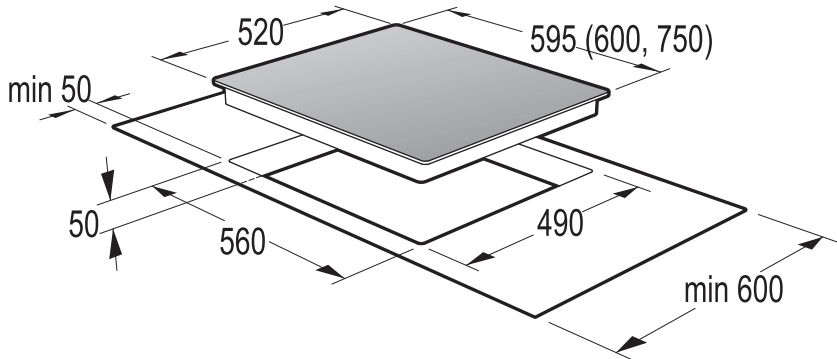

If the hob is wider than the cutout, with a worktop less than 49 mm thick, saw a cut-out in both sides of the cutout, so the appliance is detached from the cutout.

Installation dimensions inside the cabinet

$X < 49 \text{ mm}: y = 49 \text{ mm} - x$

$X \geq 49 \text{ mm}: y = 0$

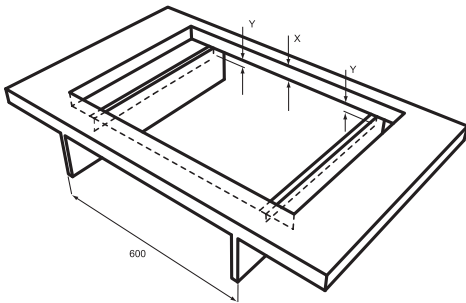

Once it has been integrated, the hob must remain accessible from underneath for service purposes.

If a drawer or oven is built in under the hob it must be easily removable.

Report any transit damage before building in the induction hob. Any damages reported afterwards will be deemed as a result of incorrect building in.

The guarantee does not cover damages resulting from the hob being built in.

The guarantee does not cover water damage or any other damage to the worktop the hob is built into.

Prior to any service call, all interior parts of the cabinet the hob is built into, such as drawer constructions, shelves, racks and runners, are to be removed.

The expert of service is responsible for the repair and service of the induction hob. You should contact your kitchen specialist about the re-integration of the induction hob.

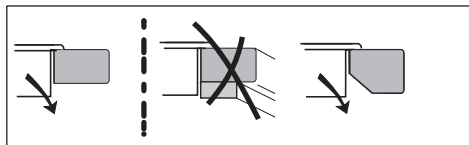

When the working table is thicker as 30 mm, then the shape of cut out on the place of cooling air output from the appliance should be modified according to the picture.

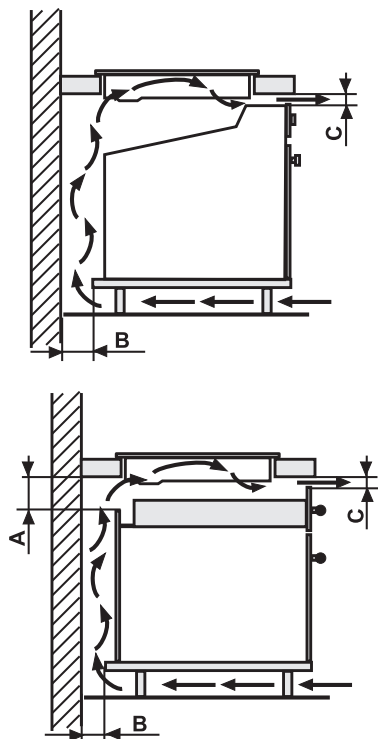

Solely company authorized to provide such activities may perform the installation of this induction hob and it should be installed in compliance with local standards and regulations.

The electric hot plate is designed, from external influence point of view, for normal indoor conditions.

The hot plate is designed for building in to cut out in the working sink of minimal thickness of 30 mm, which is covered with heat resistant material.

The sink has to be installed in horizontal position and has to be sealed against leaking in of liquids on the wall side.

The dimensions of cut out for the induction hob and its position are shown on the picture of installation.

Also the safe distances to be observed of induction hob from walls and furniture are shown on the picture.

We recommend to cover the in the cut out created cut surfaces with appropriate varnish (for instance silicon varnish) or Al-foil, respectively, which decrease the intrusion of humidity into the sink plate.

It is not allowed - without special measures - to install ovens under the hot plate, where the burnt gases from the oven could stream upwards under the induction hob .

Also the rear wall of kitchen unit has to be from heat resistant material (120° C). The smallest distance of induction hob rear edge from the rear wall is 50 mm.

The induction hob should not be installed in close neighborhood of kitchen cabinet made from flammable material, which extends over the surface of sink.

We recommend installing over the induction hob a vapor absorber only (digester); over this absorber a kitchen cabinet can be installed. We do not recommend the installation of independent cabinet without vapor absorber directly over the induction hob . The minimal distance of induction hob from the vapor absorber is 760 mm; you should further observe the recommendations of absorber producer here.

A (mm)	B (mm)	C (mm)
50	20	5

The rear wall of lower cabinet in the area of cut out has to be open, for to ensure the air exchange.

The front reinforcement of furniture should be removed, for to enable of creation of opening for passage of air, at least in a height of 5 mm under the sink over the whole length of appliance.

The eventual reinforcements under the sink should be removed at least in the area of sink. The distance between the induction cooking plate and kitchen furniture, or other built in appliances, eventually, should be chosen so, that the sufficient ventilation of induction cooking zones would be provided. The minimal distance 50 mm of kitchen unit content (the content of drawer) from the plate cover should be observed.

The excessive heating up from below - for instance from the built in stove without cooling ventilator - should be prevented.

When at eventually built in stove (roaster) - located under the built in cooking plate - a pyrolysis process (high frequency cleaning) is in operation, than the induction cooking plate should not be used.

THE CONNECTION OF APPLIANCE TO THE POWER MAINS

The appliance must be connected to power mains with authorized body only. A switch has to be connected into the circuit before the appliance for disconnecting of appliance from the power mains and with minimal distance of disconnected contacts of 3 mm. This obligation is not necessary, when the supply cord is provided with a plug and this plug can be easily and without obstruction pulled out from the socket.

To connect a hot plate, use a 3 wire cable with 4mm cross-section, e.g. H05VV-F 3G4, or a 4 wire cable with 2,5 mm cross-section, e.g. H05VV-F 4G2,5. Adjust the endings according to the picture.

The cable ends should be fastened against fraying with pressed on cable ends.

Put the cable into the terminal box and secure against pulling up with clip after fastening of core ends under the screw heads of terminals.

Close the terminal box cover at the end.

After connecting turn the appliance into working position, insert it to the cut out of the desk and check the position of connection cable.

Remove the top foil from the sealing on the lower plate edging, insert the plate into the opening of your kitchen unit and press the edgings gently as not to damage the appliance.

CONNECTION

1/N/PE ~ 220-240V

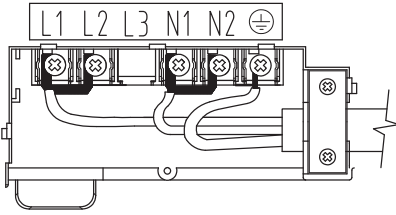

2/N/PE ~ 400V

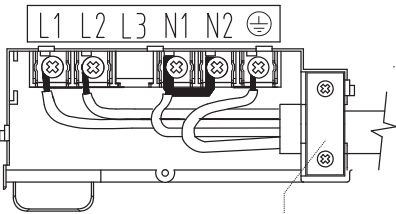

CLIP AGAINST
CORD TEARING

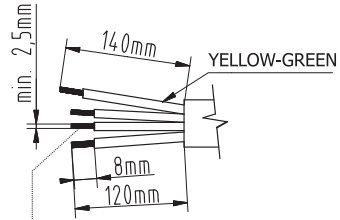
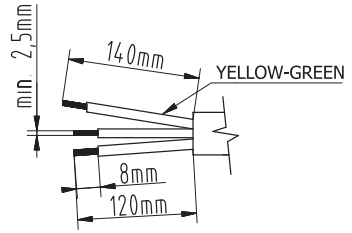

CONDUCTOR ENDS BRACED
WITH PRESSED TERMINAL

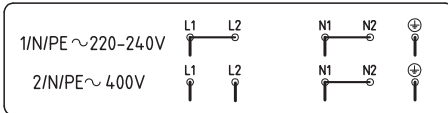

TECHNICAL DATA

Accessories	
Cleaning scrape	1

Technical data		
Electric induction built in cooking plate	IS655ST	IS756ST
Dimensions		
Total dimensions - W x D x H (H = built in depth)	595 / 520 / 60 mm	750 / 520 / 60 mm
Dimensions of cut out in the working sink Width x Depth x Thickness of sink	560 x 490 x (30 - 50) mm	
Cooking zones		
Left front	200x200 mm, 1800/3000 kW	
Left rear	200x200 mm, 1800/3000 kW	
Right front	200x200 mm, 1800/3000 kW	
Right rear	200x200 mm, 1800/3000 kW	
Left and right flexi zone		200x400 mm 3000/4000 kW
Left flexi zone	200x400 mm 3000/4000 kW	
Electric voltage	220-240 V/400 V -; 50/60 Hz	
Total electric input	7.2 kW	

PRODUCT INFORMATION REGULATION (EU) NO 66/2014

PRODUCT INFORMATION REGULATION (EU) NO 66/2014				
	Symbol	Unit	Value	Value
Supplier's name or trade mark			GORENJE	GORENJE
Model identification			IS756ST	IS655ST
Type of induction hob				
Number of cooking zones and/or areas			4	4
Heating technology	EE electric burner		induction cooking zones and cooking areas	induction cooking zones and cooking areas
Dimensions of cooking zones and / or areas	L W	cm	20.0	20.0
			20.0	20.0
Energy consumption per cooking zone or area	ECElectric cooking	Wh/kg	200.7	203.6
			202.6	200.8
			181.9	181.3
			198.7	182.1
Energy consumption for induction hob	EE electric hob	Wh/kg	196.0	192.0

MORA MORAVIA, s.r.o., Hlubočky - Mariánské Údolí, Czech republic

SAP 512850



The producer reserves the right for small modifications of manual, following from the technical or technological changes of product, which have no influence to the function of product.

MORA



en (10-15)