

EN

**DETAILED
INSTRUCTIONS FOR
USE** OF UPRIGHT
REFRIGERATOR AND
FREEZER

gorenje

BY

S+ARCK®

We thank you for the confidence you have shown by purchasing our appliance. We wish you find a lot of pleasure in its use.

The appliance is intended solely for household use.

Refrigerator freezer (hereinafter: the appliance) consists of two parts: the upper part is the refrigerator and the lower part is the freezer.

The refrigerator is intended for storing fresh food at temperatures above 0°C.

The freezer is intended for freezing fresh food and for long-term storage of frozen food (up to one year, depending on the type of food).

TABLE OF CONTENTS

4 IMPORTANT NOTES AND WARNINGS	INTRODUCTION
8 ADVICE FOR SAVING POWER WITH REFRIGERATION APPLIANCES	
9 APPLIANCE DESCRIPTION	APPLIANCE DESCRIPTION
10 INSTALLATION AND CONNECTION	
11 OPERATING THE APPLIANCE	
15 APPLIANCE INTERIOR EQUIPMENT	
17 RECOMMENDED DISTRIBUTION OF FOOD IN THE APPLIANCE	
18 STORING FOOD IN THE REFRIGERATOR	STORING AND FREEZING FOOD
19 STORING FOOD IN THE FRESHZONE DRAWER	
20 FREEZING AND STORING FROZEN FOOD	
20 Freezing process	
21 Important warnings on freezing fresh food	
21 Storage of industrially frozen food	
22 Frozen food storage time	
22 Defrosting frozen food	
23 DEFROSTING THE APPLIANCE	DEFROSTING AND CLEANING THE APPLIANCE
24 CLEANING THE APPLIANCE	
25 TROUBLESHOOTING	OTHER
27 INFORMATION ABOUT APPLIANCE NOISE	

IMPORTANT NOTES AND WARNINGS



This appliance can be used by children aged from 8 years and above and persons with reduced physical, sensory or mental capabilities or lack of experience and knowledge if they have been given supervision or instruction concerning use of the appliance in a safe way and understand the hazards involved. Children shall not play with the appliance. Cleaning and user maintenance shall not be made by children without supervision.

Before connecting the appliance to the power mains, please read carefully the instructions for use which describe the appliance and its correct and safe use. The instructions apply for several appliance types/models; thus, settings or equipment may be described herein which is not available in your appliance. The instruction manual includes the NO FROST version/model of the freezer which is fitted with a fan and in which the defrosting process is automatic.

Remove the packaging intended for protecting the appliance or particular parts during transport.

On the housing of the appliances the spacers are installed, which should be removed and replaced with the attached spacer-plugs.

Before connecting the appliance to the power mains, let the appliance rest in a vertical position for approximately 2 hours. This will reduce the possibility of operation faults due to the effect of transport on the cooling system.

The appliance must be connected to the power mains and grounded in compliance with the effective standards and regulations.

Do not store explosive substances such as aerosol cans with a flammable propellant in this appliance.

The appliance may not be used outdoors and it may not be exposed to rain.

After the installation, the appliance mains plug should be accessible!

Before cleaning the appliance, unplug the appliance from the power mains (unplug the power cord from the wall outlet).

If the power cord is damaged, it must be replaced by a service technician or other adequately trained person.

If the appliance will be out of use for a prolonged period of time, switch it off using the relevant button, and unplug the appliance from the power mains. Empty the appliance, defrost it, clean it, and leave the door ajar.

If LED lighting does not work, call a service technician. Do not attempt a repair of the LED lighting yourself, as there is danger of contact with high voltage!

To protect the environment, take the obsolete appliance to an authorized home appliance collection center.

Packaging is made of environmentally friendly materials that can be recycled, disposed of, or destroyed without any hazard to the environment.

Self closing shear door hinge pulls the door to the cabinet just before closing, thereby preventing the door to remain ajar. Equally it limits the door opening angle and prevents damage to adjacent elements.

Rating plate with basic information is located in the interior of the appliance. If the sticker plate is not suitable for your language, replace it with the attached one.

WARNING! Keep ventilation openings, in the appliance enclosure or in the built-in structure, clear of obstruction.

WARNING! Do not use mechanical devices or other means to accelerate the defrosting process, other than those recommended by the manufacturer.

WARNING! Do not damage the refrigerant circuit.

WARNING! Do not use electrical appliances inside the food storage compartments of the appliance, unless they are of the type recommended by the manufacturer.



The symbol on the product or on its packaging indicates that this product may not be treated as household waste. Instead it shall be handed over to the applicable collection point for the recycling of electrical and electronic equipment. By ensuring this product is disposed of correctly, you will help prevent potential negative consequences for the environment and human health, which could otherwise be caused by inappropriate waste handling of this product. For more detailed information about recycling of this product, please contact your local city office, your household waste disposal service or the shop where you purchased the product.

ADVICE FOR SAVING POWER WITH REFRIGERATION APPLIANCES

- Install the appliance as specified in the instruction manual.
- Do not open the door more often than necessary.
- Occasionally make sure air circulation underneath the appliance is unobstructed.
- Condenser unit on the rear wall should be kept clean (see chapter Cleaning the appliance).
- If the gasket is damaged or does not provide a perfect seal for other reasons, have it replaced as soon as possible.
- Store the food in tightly sealed containers or appropriate packaging.
- Before placing the food in the appliance, cool it to room temperature.
- Defrost frozen food in the refrigerator compartment.
- Remove some of the drawers from the freezer compartment as described in the instruction manual, in order to make use of the entire interior.
- Defrost your conventional freezer when an approximately 3-5 millimeter layer of frost or ice has built up on the refrigerated surfaces.
- Make sure the layout of shelves in the compartment is uniform and that the food is placed so that the air can freely circulate in the appliance interior (observe the recommended placement of food as described in the instructions).
- In appliances with a fan, do not block the fan slots.

APPLIANCE DESCRIPTION

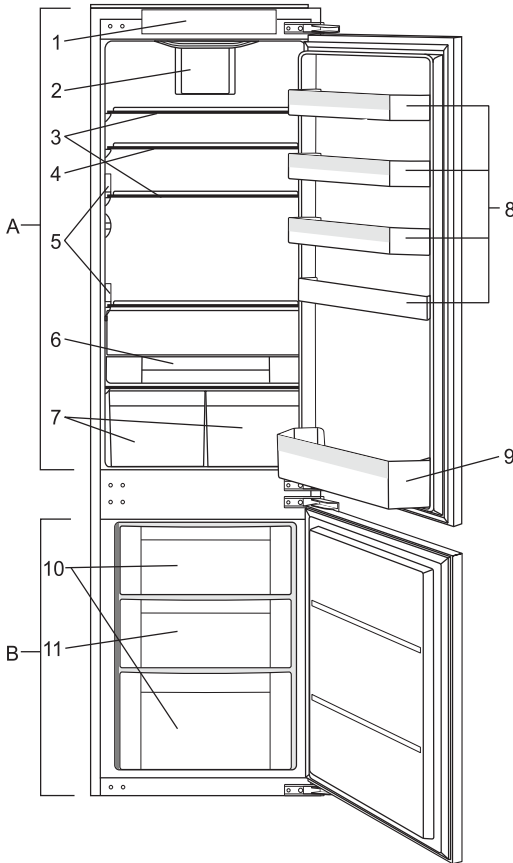

A Refrigerator

- 1 Control panel
- 2 Fan
- 3 Pull-out glass shelf (height-adjustable)
- 4 Pull-out glass shelf – short
- 5 LED lighting of refrigerator interior
- 6 FreshZone pan
- 7 Fruit and vegetable bin
- 8 Refrigerator door pans (options: deep, shallow)
- 9 Door bottle rack with safety holder

B Freezer

- 10 Storage compartment
- 11 Freezing compartment

INSTALLATION AND CONNECTION

SELECTING THE ROOM

- Install the appliance in a dry and well ventilated room. The appliance will operate correctly if the environment temperature is in the interval specified in the table. The appliance class is indicated on the rating plate / label with the basic information on the appliance.

Class	Ambient temperature
SN (subnormal)	from + 10°C to + 32°C
N (normal)	from + 16°C to + 32°C
ST (subtropical)	from + 16°C to + 38°C
T (tropical)	from + 16°C to + 43°C

Warning: Make sure the room where the appliance is installed is large enough. There should be at least 1 m³ of space per 8 grams of refrigerant. Amount of refrigerant is stated on the rating plate in the appliance interior.

INSTALLING THE APPLIANCE

Appliance installation should be carried out by at least two persons to avoid any physical injury or damage to the appliance.

- The appliance must stand level and stable on a solid base.
- Do not expose the appliance to direct sunlight and do not place it near any source of heat. If this cannot be avoided, install an insulation panel.
- Be sure to leave enough space for cooling of condenser (distance from the wall or the opening should be 200 cm²). Distance to the cabinet above the appliance should be at least 5 cm.
- After the installation, the appliance mains plug should be accessible!

CONNECTING THE APPLIANCE

- Connect the appliance to the power mains using a connection cable. The wall outlet should be fitted with a ground contact (safety socket). Nominal voltage and frequency are indicated on the rating plate/label with basic information on the appliance.
- The appliance must be connected to the power mains and grounded in compliance with the effective standards and regulations. The appliance will withstand short-term deviations from the nominal voltage, but not more than +/- 6%.

OPERATING THE APPLIANCE

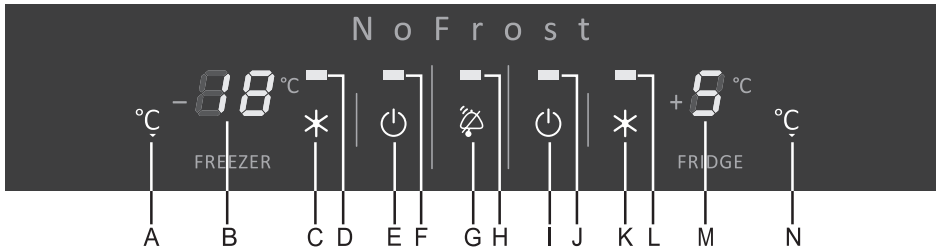

- A Freezer temperature key**
- B Freezer temperature digital display:** displays temperature in the range from -16°C to -24°C
- C Super freeze on/off key**
- D Signal light:** on when super freeze is activated
- E Appliance on/off key (refrigerator and freezer)**
- F Signal light:** on when the freezer is operating
- G Acoustic alarm acknowledgement and child lock on/off key**
- H Signal light:** on when alarm is activated
- I Refrigerator on/off key**
- J Signal light:** on when the refrigerator is operating
- K Extra cooling power on/off key**
- L Signal light:** on when super extra cooling power is activated
- M Refrigerator temperature digital display:** displays temperature in the range from +1°C to +9°C
- N Refrigerator temperature key**

SWITCHING THE APPLIANCE ON/OFF

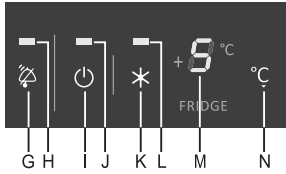
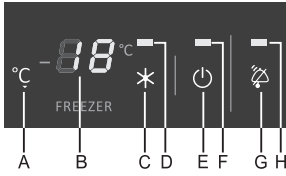

To switch on the appliance for the first time, connect the plug to a mains socket. The displays will indicate dashes to inform you that the refrigerator and the freezer are off.

- To switch on the appliance, press the **E** key and hold it for 3 seconds. Refrigerator and freezer will be switched on and the signal lights **F** and **J** will light up. In this mode, you may switch off the refrigerator only by pressing the **I** key and holding it for 3 seconds (signal light **J** will go off).
- Refrigerator temperature of +9°C and freezer temperature of 0°C are displayed. These values will remain on respective displays until the temperature in each compartment falls below these values.
- The appliance is preset to the recommended refrigerator temperature of +5°C and freezer temperature of -18°C.

ADJUSTING THE TEMPERATURE

Refrigerator temperature range:	from +1°C to +9°
Freezer temperature range:	from -16°C to -24°C + super freeze

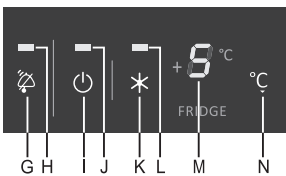

- Adjust the freezer temperature with the **A** key and refrigerator temperature with the **N** key.
- When one of the temperature adjustment keys is pressed, the display will start flashing and the most recent setting will be displayed.
- To adjust the temperature, briefly press the relevant key. Each time the key is pressed, the temperature is changed by 1°C. While the settings are being adjusted, all other keys are disabled.
- Approximately 5 seconds after releasing the key (inactivity), the most recently set temperature will be stored. Actual refrigerator or freezer temperature will be displayed.

OTHER SETTINGS

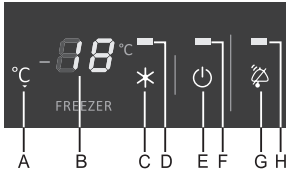

Continuous acoustic signal - open refrigerator door alarm

If the refrigerator door is open for more than one minute, a continuous acoustic signal is activated and the signal light **H** will light up. The acoustic alarm will go off when the door is closed or when the alarm is acknowledged with the **G** key.

Intermittent acoustic alarm - high refrigerator/freezer temperature alarm

When the temperature is too high, an intermittent acoustic signal will be activated and the temperature display will flash.

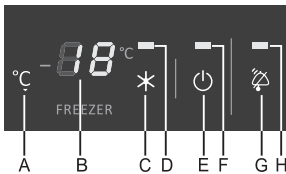

- Acknowledge the acoustic alarm by pressing the **G** key. As soon as the temperature in the freezer/refrigerator drops to a level that no longer represents food spoilage hazard, the signal light **H** will go off and the display will stop flashing.
- If 24 hours after acknowledging the alarm the temperature in the freezer is still not safe, the acoustic alarm will be reactivated. The alarm will go off automatically when the temperature drops to a level that no longer represents food spoilage. After the appliance is switched on for the first time, there is a 24-hour delay in alarm operation to prevent unnecessary activation.

Intermittent acoustic signal - power failure alarm

If the temperature in the refrigerator or freezer rises too high as a result of a power failure, an intermittent acoustic signal will be activated, signal light **H** will light up, and the highest actual temperature will be indicated on a flashing display (for refrigerator, the maximum temperature is 9°C).

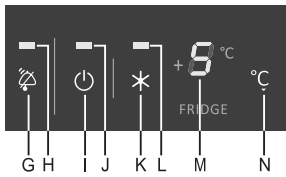

Extra cooling power (refrigerator boost)

Press the **K** key to activate the extra cooling power (refrigerator boost). Signal light **L** will light up. In this case, the fan is operating as well, but only when refrigerator door is closed. After six hours, the function is deactivated and the settings will return to the most recent values. This function is intended for fast cooling of a large amount of food.

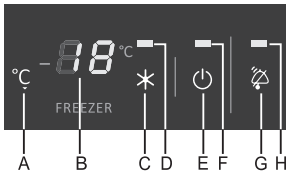

Super freeze function

Press the **C** key to activate the super freeze function (freezer boost). Signal light **D** will light up. Super freeze will be activated.

If the function is not deactivated manually, the setting is switched off automatically approximately two days after activation. This function is intended **for fast freezing of a large amount of food**. In case of a power failure, the super freeze process is restarted. Use this setting after switching on the appliance for the first time, before cleaning, or when inserting a large amount of food.

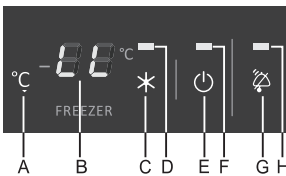

Child lock

The built-in child lock prevents any inadvertent or unwanted changes to the settings/temperature or even switching the appliance off. Engage/disengage the lock by pressing the **G** key and holding it for 3 seconds ('LL' and 'L', respectively, will flash on the displays for 3 seconds). When the lock is engaged, only the child lock deactivation key is active. If any other key is pressed, the displays will read 'LL' and 'L', respectively.

APPLIANCE INTERIOR EQUIPMENT

SHELF

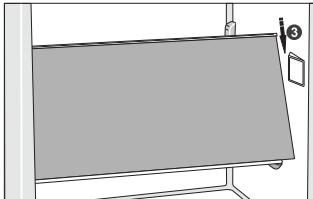
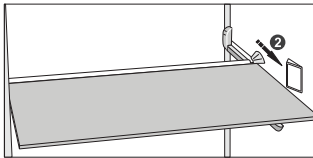
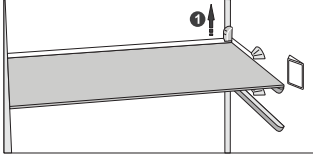

- The shelves may be adjusted to suit your preferences using the guides in the refrigerator interior.
- Each shelf is fitted with a locking device at the back, which prevents it from being pulled out unintentionally. If you wish to pull out a shelf (to move to another position or for cleaning), please proceed as follows:
 1. lift the rear end of the shelf;
 2. pull out the shelf along the guides at the sides as far as the door;
 3. rotate the shelf upwards or downwards, depending on the position of the lighting device.

To replace the shelf, follow the procedure in reverse.

Store perishables at the back of the shelf where the temperature is the lowest

FRUIT AND VEGETABLE BIN

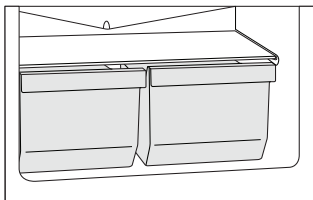

- The bin at the bottom of the refrigerator is intended for storing fruit and vegetables. It provides humidity and prevents the food from drying out. Store the food in suitable packaging to prevent them from emitting or taking on odours.

INTERIOR SIDE OF THE REFRIGERATOR DOOR

Mounted on the refrigerator door are compartments (shelves or bins) intended for storing cheese, butter, eggs, yoghurt and other smaller packages, tubes, cans, etc. There is a bottle shelf at the lower end of the door.

FAN

- Fan fixed under the ceiling or hidden behind the rear refrigerator panel or within the freezer compartment improves even distribution of temperature and decreases dew upon storage racks.

STORAGE BIN (MULTIBOX)

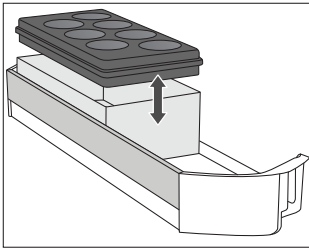

- **MultiBox** bin offers a convenient way for storing food with a strong or pungent smell, e.g. ripened or blue-vein cheese, sausages, onions, butter etc.
 - The silicone lid provides an air-tight seal that prevents the food from drying out and the odour to spread throughout the refrigerator compartment.
 - The silicon lid can also be used as an egg or ice tray.
-
- If the flexible lid is used as an egg tray, place it directly on the bottom of the door bin and use the open lower part of the Multibox bin to store food in smaller packages – pâté, jams, smaller tubes etc.

RECOMMENDED DISTRIBUTION OF FOOD IN THE APPLIANCE

Sections of the refrigerator:

- **upper part:** canned food, bread, wine, pastry etc.
- **middle part:** dairy products, ready-made meals, desserts, soft drinks, beer, cooked food, etc.
- **Fresh bin:** - meat, meat produce, delicatessen;
- **Fruit and vegetable bin:** fresh fruit, vegetables, salads, root vegetables, potatoes, onions, garlic, tomatoes, tropical fruit, sauerkraut, turnips etc.

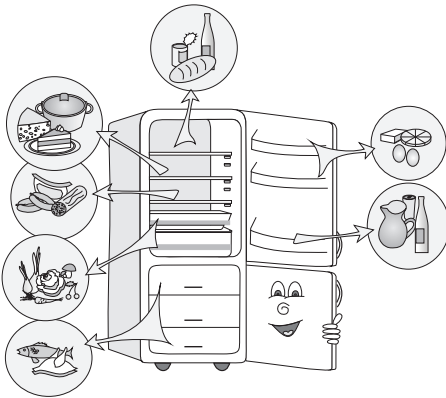

Sections in the refrigerator compartment door:

- **upper/middle door bins:** eggs, butter, cheese etc.
- **lower door bins:** beverages, cans, bottles etc.

Freezer sections:

- freezing, storage of frozen food (see Freezing and Storing Frozen Food).

STORING FOOD IN THE REFRIGERATOR

IMPORTANT WARNINGS REGARDING FOOD STORAGE



Correct use of the appliance, appropriate packaging, maintaining the right temperature, and observing the food hygiene standards has a decisive impact on the quality of food storage.

Observe the expiry dates for the food, specified on the packaging.

Food stored in the refrigerator should be kept in closed containers or appropriate packaging to prevent them from emitting or receiving odours.

Do not store inflammable, volatile, and explosive substances in the refrigerator.

Bottles with high alcohol content should be tightly sealed and stored in an upright position.

Some organic solutions, essential oils in lemon and orange peel, butter acid, etc. may damage the plastic surfaces in case of a prolonged contact, causing damage and premature ageing of these materials.

Unpleasant odour warns of lacking cleanliness of the appliance or perished contents (see Cleaning the Appliance).

If you are leaving home for a longer period of time, remove perishables from the refrigerator.

FOOD STORAGE TIMES

Recommended storage time in the refrigerator

Type of food	Time
eggs, marinades, smoked meat	up to 10 days
cheese	up to 10 days
root vegetables	up to 8 days
butter	up to 7 days
deserts, fruit, ready-to-eat food, chunks of raw meat	up to 2 days
fish, raw minced meat, seafood	up to 1 day

STORING FOOD IN THE FRESHZONE DRAWER

In the **FreshZone** compartment, food stays fresh longer than in a conventional refrigerator, retaining more flavour and nutrients.

Decay and loss of mass are slowed down; therefore, fruit and vegetables remain fresh and natural longer.

For optimum performance, the drawer should be fully closed.

- When buying food, make sure it is fresh as this will determine the quality of the food, as well as how long it will keep in the fridge.
- Store the food in closed containers or appropriate packaging to prevent them from emitting or receiving odours.
- Take the food from the drawer 30-60 minutes before use to allow the aroma and flavour develop at room temperature.
- Food sensitive to low temperature and not appropriate for storage in the **FreshZone** drawer include the following: pineapple, avocado, bananas, olives, potatoes, eggplant, cucumbers, beans, peppers (capsicum), melons, watermelons, pumpkins, squash, zucchini etc.
- To remove the drawer:
 - remove the vegetable bin;
 - remove the glass shelf above and, with some models, under the FreshZone drawer;
 - if necessary (with some models), remove the drawer door (1): open, hold in the middle (as shown in the figure), bend slightly and simultaneously pull up towards you;
 - pull out the drawer to the position indicated in the figure (detail «A»), rotate it downwards and remove it.
 - To replace the drawer, observe the reverse order.

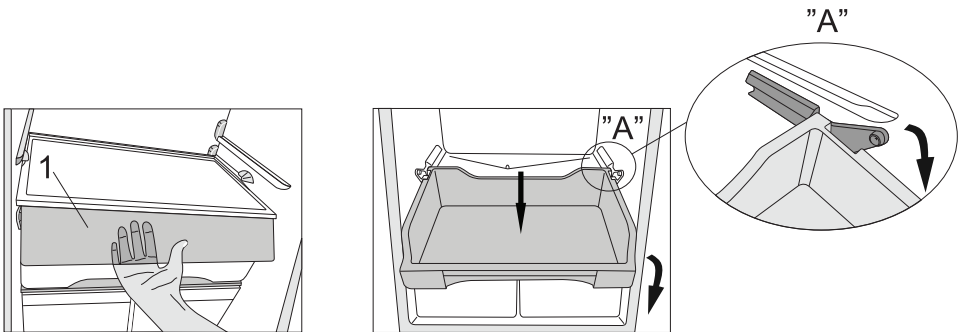

FREEZING AND STORING FROZEN FOOD

FREEZING PROCESS



Maximum amount of fresh food that may be inserted at once is specified on the appliance rating plate. If the amount of food to be frozen exceeds the indicated amount, the quality of freezing will be inferior; in addition, the quality of the food already frozen will deteriorate.

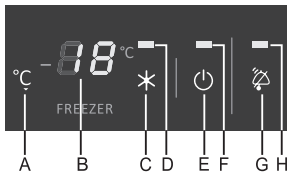

- Activate the super freeze function 24 hours before freezing fresh food:
- press the **C** key.

After this time, insert the fresh food into the freezing compartment.

Make sure the fresh food is not in contact with the food that is already frozen!

Be sure to provide the NO FROST freezer models with enough room below the ceiling for cool air circulation, so avoid storing food over the marked maximum storage level (see Fig.).

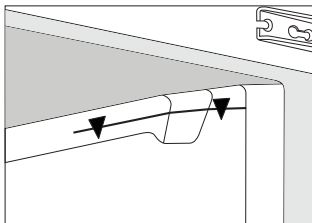

- After 24 hours you may relocate the food **to the storage compartment**, and repeat the freezing procedure if required. You may also remove the drawers and store frozen food directly on cooling shelves. Do not remove the lower drawer if you have a NO FROST appliance!
- For freezing smaller quantities of fresh food (1-2 kg), the engagement of the fast freeze function is not required.

IMPORTANT WARNINGS ON FREEZING FRESH FOOD



Only freeze the food that is suitable for freezing in the freezer. Make sure the food you freeze is of high quality and fresh.

Choose appropriate packaging and use the packaging correctly.

Packaging should not be permeable to humidity; it should be airtight to prevent the food from drying out and loss of vitamins.

Label the food; indicate the type of food, amount, and date of freezing.

It is important that the food is frozen as quickly as possible. Therefore, keep the packages small. Refrigerate the food before freezing.

STORAGE OF INDUSTRIALLY FROZEN FOOD

- When storing and using frozen food, observe the manufacturer's instructions. Temperature and expiry date are indicated on the packaging.
- Only choose food with undamaged packaging, stored in freezers at temperatures of -18°C or lower.
- Do not purchase food covered in frost as this indicates they have been partly defrosted several times and that they are of inferior quality.
- Protect the food from thawing during transport. In case of an increase in temperature, storage time will be shorter and quality will deteriorate.

FROZEN FOOD STORAGE TIME

Recommended storage time in the freezer

Type of food	Time
fruit, beef	from 10 to 12 months
vegetables, veal, poultry	from 8 to 10 months
Venison	from 6 to 8 months
Pork	from 4 to 6 months
minced meat	4 months
bread, pastry, ready-to-eat meals, lean	3 months
entrails	2 months
smoked sausage, fatty fish	1 month

DEFROSTING FROZEN FOOD

Freezing the food does not kill the microorganisms. After the food is defrosted or thawed, bacteria is re-activated and the food spoils quickly. Use the partially or completely defrosted food as soon as possible.

Partial thawing decreases the nutritive value of the food, particularly fruit, vegetables, and ready-to-eat food.

DEFROSTING THE APPLIANCE

AUTOMATIC DEFROSTING OF THE REFRIGERATOR

Refrigerator needs no special defrosting procedure, because ice deposited at the inner back wall is defrosted automatically.

Ice deposited on the inner back wall during the compressor operation is defrosted when the compressor stops operating, and condensed water drops are drained through the outlet in the inner back wall into the drain pan situated above the compressor where it evaporates.

In case you should notice excessive ice formation at the rear refrigerator panel (3-5 mm thick), switch the appliance off and thaw it manually.

DEFROSTING A NO FROST FREEZER

- The NO FROST freezer will defrost automatically. Occasional frost that may appear on the walls will disappear automatically.
- Build-up of ice or frost in the freezer compartment can be a result of abnormal use of appliance (door opened too frequently and/or too long, door not properly closed etc.). In this case, switch off the appliance (see chapter Switching the appliance on/off) and unplug the power cord.
- Remove the food from the freezer and protect them from defrosting.
- Never use powered appliances to defrost the freezer (hair dryer, etc.) - LIFE THREATENING!
- Do not use any defrosting sprays as they may melt the plastic parts or harm your health.
- Clean and dry the freezer interior. Before returning the frozen food into the freezer, switch on the appliance and select the desired setting.

CLEANING THE APPLIANCE

Before cleaning, unplug the appliance from the power mains – switch off the appliance (see chapter Switching the Appliance On/Off) and unplug the power cord from the wall outlet.

- Use a **soft cloth** to clean all surfaces. Cleaners that contain **abrasive substances, acids, or solvents are not suitable for cleaning** as they may damage the surface.

Clean the appliance **exterior** with water or a mild solution of suds. Lacquer-coated and aluminium surfaces may be cleaned with lukewarm water to which you have added a mild detergent. Use of cleaners with low alcohol content is allowed (e.g. window cleaners). Do not use cleaners containing alcohol for cleaning plastic materials.

Appliance interior can be cleaned with lukewarm water to which you can add some **vinegar**.

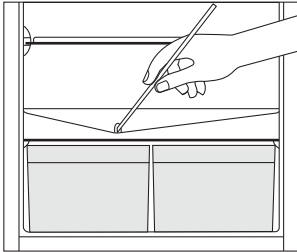

- A gutter and an opening through which the water from thawed ice flows are located underneath the cooling panel that cools the refrigerator interior. The gutter and the opening may not be clogged. Inspect them often and clean if necessary (e.g. with a plastic straw).
- Frost or ice build-up, 3-5 mm thick, will increase power consumption. Therefore, it should be regularly removed (does not apply to NO FROST freezer). Do not use any sharp objects, solvents, or sprays.

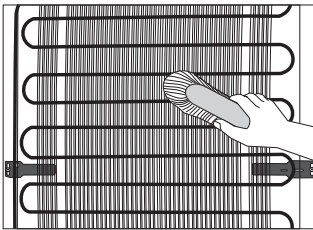

- The **condenser** unit mounted on the (exterior) back wall should always be kept clean, free of dust or deposits resulting from kitchen smoke or fumes.. Occasionally clean the dust using a soft non-metal brush or a vacuum cleaner.

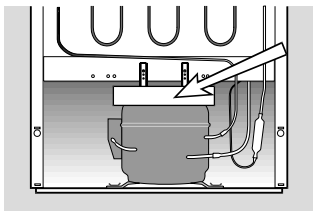

- Clean also the **drip pan** above the compressor. If you removed the pan, please make sure you replace it to the same position, and check that it is in completely horizontal position!
- After cleaning, switch the appliance back on and insert the food.

TROUBLESHOOTING

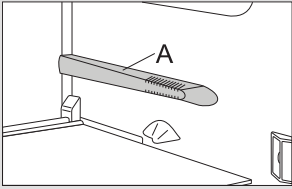
Fault:	Cause/Remedy
Appliance is connected to the power mains but it does not work.	<ul style="list-style-type: none"> • Make sure there is voltage in the power outlet and that the appliance is switched on.
Cooling system operates continuously for a long period of time: 	<ul style="list-style-type: none"> • Too high environment temperature. • Door opened too frequently or too long. • Door not closed correctly (possible impurities on the seal, misaligned door, damaged seal etc.). • Too much fresh food inserted at once. • Sensor in the refrigerator (A) blocked by fresh food. Make sure the air can circulate around the sensor. • Insufficient compressor and condenser cooling. Check the air circulation behind the appliance and clean the condenser unit.
Excessive build-up of ice on the back wall of refrigerator interior can be a result of the following:	<ul style="list-style-type: none"> • Door opened too frequently or too long. • Warm food placed in the refrigerator. • Food in contact with the back interior wall of the refrigerator. • Poor door sealing. • If the seal is dirty or damaged, clean it or replace it.
Build-up of ice or frost in the freezer interior may be a result of the following:	<ul style="list-style-type: none"> • Door opened too frequently or too long. • Door not properly closed. • Poor door sealing. • If the seal is dirty or damaged, clean or replace it.
Water leaking from the refrigerator:	<ul style="list-style-type: none"> • Clogged water discharge opening or water dripping past the water gutter. • Clean the clogged opening, for example using a plastic straw. • If a thick layer of ice builds up, defrost the appliance manually (see Defrosting the Appliance).
Flashing signal light H : (only for the freezer compartment)	<ul style="list-style-type: none"> • Door opened too frequently or too long. • Door not closed correctly (possible impurities on the seal, misaligned door, damaged seal, etc.). • A longer power failure. • Too much fresh food inserted at once.
Door is difficult to open:	<ul style="list-style-type: none"> • If you are trying to open the freezer door after just having closed it, this could be difficult to do. As you open the door, some cool air escapes from the appliance and it is replaced by warm air from the environment. When this air is cooled, negative pressure is generated which results in problems as you try to open the door. After a few minutes, the condition is normalized and the door can be easily opened again.

Fault:	Cause/Remedy
LED lighting does not work:	<ul style="list-style-type: none"> • If LED lighting does not work, call a service technician. • Do not attempt a repair of the LED lighting yourself, as there is danger of contact with high voltage!
Error code indicated on the display:	<ul style="list-style-type: none"> • If “E” appears on the display, call a service technician.

If none of the instructions above fixes your problem, call the nearest authorized service center and state the type, model, and serial number found on the rating plate/label which is located in the appliance interior.

INFORMATION ABOUT APPLIANCE NOISE

Cooling in refrigerator freezers is made possible by a cooling system that also includes a compressor (and a fan with some appliances), which generates some noise. The level of noise depends on installation, proper use, and age of the appliance.

- **After connecting the appliance to the power mains**, compressor operation, or the sound of flowing liquid, may be somewhat louder. This is not a sign of malfunction and it will not affect the useful life of the appliance. In time, appliance operation and this noise will become quieter.
- Sometimes, **unusual or loud noise** may appear during appliance operation; these are mostly the result of improper installation:
 - The appliance must stand level and stable on a solid base.
 - The appliance may not be in contact with a wall or adjacent furniture.
 - Make sure the interior equipment sits firmly in its place and that the noise is not caused by cans, bottles or other containers placed next to each other.
- Due to the higher workload on the cooling system when the door is opened more frequently or for a longer time, when a large amount of fresh food is introduced, or when intensive freezing or cooling functions are activated, the appliance can temporarily generate more noise.

WE RESERVE THE RIGHT TO MAKE CHANGES THAT DO NOT AFFECT THE FUNCTIONALITY OF THE APPLIANCE.

Instructions for use of the appliance can also be found on our website at www.gorenje.com / < <http://www.gorenje.com> />

COMBI 54_STARCK



503486

en (08-15)