

---

# **gorenje<sup>+</sup>**

**DETAILED INSTRUCTIONS  
FOR USE OF A COMBINED  
MICROWAVE OVEN**



---

We thank you for your trust and the purchase of our appliance.

This detailed instruction manual is supplied to make the use of this product easier. The instructions should allow you to learn about your new appliance as quickly as possible.

Make sure you have received an undamaged appliance. If you do find transport damage, please contact the seller from which you purchased the appliance, or the regional warehouse from which it was supplied. The telephone number can be found on the invoice or on the delivery note.

Instructions for installation and connection are supplied on a separate sheet.

Instructions for use are also available at our website:

[www.gorenje.com](http://www.gorenje.com) / < <http://www.gorenje.com> />



Important information



Tip, note

# CONTENTS

---

<b>4 COMBINED MICROWAVE OVEN</b> 7 Technical specifications 8 Control unit .....	<b>INTRODUCTION</b>
<b>10 IMPORTANT SAFETY INSTRUCTIONS</b> 13 Before connecting the oven:	
<b>14 BEFORE USING THE APPLIANCE FOR THE FIRST TIME</b> .....	<b>PREPARING THE APPLIANCE FOR THE FIRST USE</b>
<b>15 SWITCHING ON THE APPLIANCE FOR THE FIRST TIME</b>	
<b>16 STEPS OF THE COOKING PROCESS (1-7)</b> 16 Step 1: CHOOSING THE BASIC COOKING MENUS AND SETTINGS 24 Step 2: TIMER FUNCTIONS - DURATION 25 Step 3: STEP COOKING 27 Step 4: START THE COOKING PROCESS 27 Step 5: END THE COOKING PROCESS AND SWITCHING OFF THE OVEN 29 Step 6: SELECTING ADDITIONAL FUNCTIONS 32 Step 7: CHOOSING THE GENERAL SETTINGS .....	<b>COOKING STEPS</b>
<b>34 DESCRIPTIONS OF SYSTEMS (COOKING MODES) AND COOKING TABLES</b>	
<b>53 MAINTENANCE &amp; CLEANING</b> 54 Conventional oven cleaning 54 Using the aqua clean function to clean the oven 55 Removing and cleaning the wire guides 56 Replacing the bulb	<b>MAINTENANCE &amp; CLEANING</b>
<b>57 TROUBLESHOOTING TABLE</b>	<b>TROUBLE-SHOOTING</b>
<b>58 DISPOSAL</b> .....	
<b>59 COOKING TEST</b>	<b>OTHER</b>

# COMBINED MICROWAVE OVEN

## (DESCRIPTION OF THE OVEN AND EQUIPMENT - DEPENDING ON THE MODEL)

The figure represents one of the built-in appliance models. Since the appliances for which these instructions were drawn up may have different equipment, some functions or equipment may be described in the manual that may not be present in your appliances.

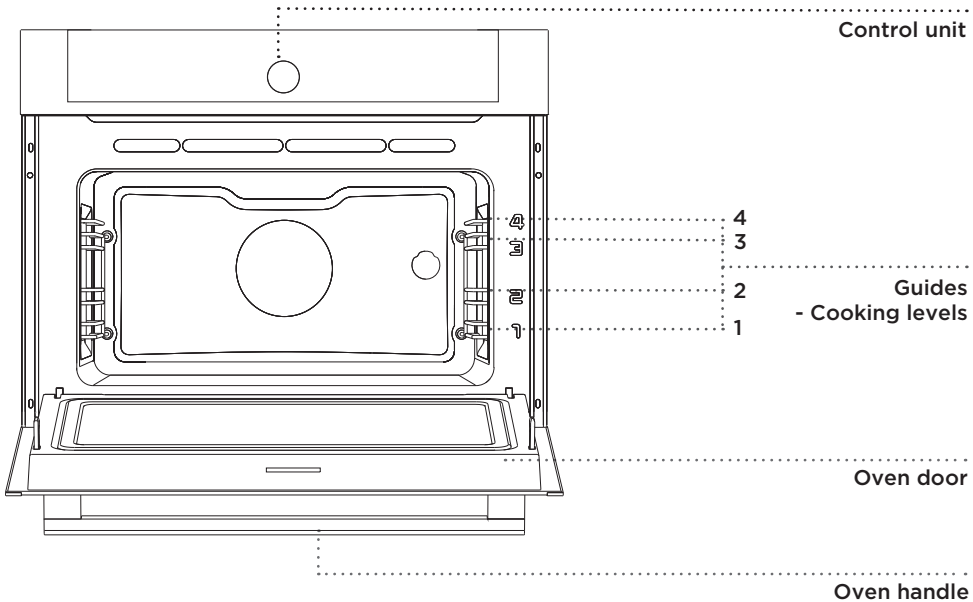

## WIRE GUIDES

The wire guides allow preparation of the food on 4 levels (please note that the levels/guides are counted from the bottom up).

Guides 3 and 4 are intended for grilling, and guide 1 is used with microwave systems when food is prepared in a glass baking dish.

## OVEN DOOR SWITCH

The switches deactivate oven heating, the fan, and the microwaves when the oven door is opened during the cooking process. When the door is closed, the switches turn the heaters and the microwaves back on.

## COOLING FAN

The appliance is fitted with a cooling fan that cools the housing and the appliance control panel.

## EXTENDED OPERATION OF THE COOLING FAN

After the oven is switched off, the cooling fan continues to operate for a short while in order to provide additional cooling for the oven. (Extended cooling fan operation depends on the temperature in the center of the oven.)

## OVEN EQUIPMENT AND ACCESSORIES (depending on the model)

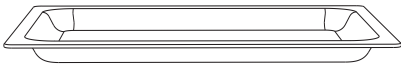

**GLASS BAKING DISH** is used for cooking with all oven systems and for cooking with microwaves. It can also be used as a serving tray.



**Never use the grid, the shallow baking sheet or the deep baking tray or any other metal part or accessory when operating a system with microwaves!**



The **GRID** is used for grilling or as support for a pan, baking tray or baking dish with the food.



There is a safety latch on the grid. Therefore, the grid has to be lifted slightly at the front when pulling it out from the oven.

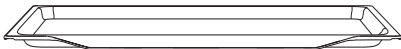

The **SHALLOW BAKING SHEET** is used for baking pastry and cakes.

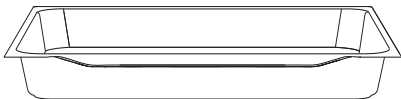

The **DEEP BAKING TRAY** is used for roasting meat and baking moist pastry. It can also be used as a drip tray.



Never place the deep baking tray in the first guide during the cooking process, except when grilling food or using the roasting spit and you are only using the deep tray as a drip tray.

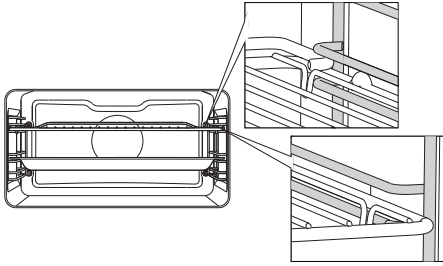

The grid or the tray should always be inserted into the groove between the two wire profiles.



**Never use the grid, the shallow baking sheet or the deep baking tray or any other metal part or accessory when operating a system with microwaves!**

# TECHNICAL SPECIFICATIONS

(DEPENDING ON THE MODEL)

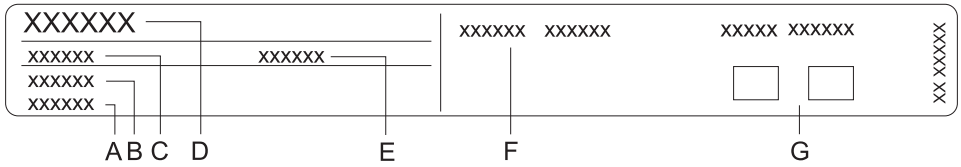

- A Serial number
- B Code/ID
- C Type
- D Brand
- E Model
- F Technical data
- G Compliance symbols

The rating plate indicating the basic information about the appliance is located at the edge of the oven and it is visible when the oven door is opened.

# CONTROL UNIT

PROFESSIONAL MODE

AUTOMATIC

MICROWAVES



**1** ON/OFF KEY

**2** OVEN  
LIGHTING ON/  
OFF KEY

**3** BACK KEY

**4** Selection and  
CONFIRMATION  
KNOB

**Touch briefly** to return to previous menu.

**Touch and hold** to return to main menu.

**Select the setting** by rotating the knob.

**Confirm your selection** by pressing the knob.



## MY RECIPES

EXTRA  
FUNCTIONS

GENERAL  
SETTINGS



**5** MINUTE  
MINDER/  
ALARM

**6** CHILD LOCK  
KEY  
Locking the control  
unit

**7** START/STOP  
KEY

Long touch: START

Long touch during  
operation: STOP

**8** DISPLAY - displays  
all settings

### NOTE:

The keys will respond better if you touch them with a larger area of your fingertip. Each time you press a key, this will be acknowledged by a short acoustic signal.

# IMPORTANT SAFETY INSTRUCTIONS

---



**CAREFULLY READ THE INSTRUCTIONS AND SAVE THEM FOR FUTURE REFERENCE.**

This appliance may only be used by children aged 8 years and above and persons with reduced physical, sensory or mental capabilities or lack of experience and knowledge if supervision or instructions are provided to them concerning use of the appliance in a safe way and if they understand the hazards involved. Do not let the children play with the appliance. Cleaning and user maintenance shall not be made by children without supervision.

**WARNING:** The appliance and some of its accessible parts may become very hot during use. Be careful not to touch the heaters. Children younger than 8 years should be constantly supervised.

The appliance becomes very hot during use. Be careful not to touch the oven heaters.

**WARNING:** The accessible parts of the appliance may become hot during use. Children should be kept away from the oven.

Only use the temperature probe recommended for use in this oven.

**WARNING:** Before replacing the light bulb, make sure the appliance has been disconnected from the power mains, in order to prevent the hazard of an electric shock.

Do not use abrasive cleaners or sharp metal scrapers to clean the oven as they may damage the finish or the protective enamel coating. Such damages may lead to cracking of the glass.

Do not use steam cleaners or high pressure cleaners to clean the appliance as this may result in an electric shock.

The appliance is not intended to be controlled with external timers or special control systems.

**The appliance is intended for household use.** Do not use it for any other purpose, such as room heating, drying of pets or other animals, paper, fabrics, herbs etc. as this may lead to injury or fire hazard.

**The appliance may only be connected** to the power mains by an authorized service technician or expert.

Tampering with the appliance or non-professional repair thereof may result in risk of severe injury or damage to the product.

**If the power cords of other appliances located** near this appliance are caught in the oven door, they may be damaged, which may in turn result in a short circuit. Therefore, keep the power cords of other appliances at a safe distance.

If the **power cord** is damaged, it should be replaced by the manufacturer or an authorized service technician, in order to avoid hazard.

Do not **line the oven** walls with aluminium foil and do not place baking trays or other cookware on the oven bottom. Aluminium foil would prevent air circulation in the oven, hinder the cooking process, and ruin the enamel coating.

Oven door become very **hot during operation**. A third glass is installed for extra protection, reducing the temperature of the outside surface (only with some models).

**Oven door hinges** may be damaged when under excessive load. Do not place heavy pans on open oven door and do not lean against open oven door when cleaning the oven cavity. Never stand on the open oven door and do not let children to sit on it.

Appliance operation is safe with and without tray guides.

Make sure the vents are never covered or obstructed in any other way.

## Safe use of the microwave oven

**WARNING:** If your oven allows combined operation (microwaves combined with other cooking modes), do not allow the children to use the oven without supervision of an adult person since the oven will reach very high temperatures in such operation modes.

**WARNING:** If the door or door sealing is damaged, do not use the oven until it is repaired by an adequately trained service technician.

**WARNING:** It is hazardous for anyone other than a competent person to carry out any service or repair operation which involves removal of the cover that protects against exposure to microwave radiation.

**WARNING:** Liquids and other foods must not be heated in sealed containers since they are liable to explode.

**Heed** the minimum distance between the upper edge of the oven and the nearest object above it.

**The appliance** is intended for use in households and similar environments, such as:

- staff pantries in stores and other working environments;
- family farms;
- accommodation units for guests at hotels, motels, and other accommodation or lodging establishments;
- bed and breakfast establishments.

The microwave oven is intended for heating food and beverages. Drying food or clothing and heating of hot packs or pads, slippers, sponges, moist cloths etc. may result in injury, ignition, or fire.

**Only use** utensils suitable for use in microwave ovens.

**When heating food** in plastic or paper containers, keep an eye on the oven as such packaging may ignite.

Microwave heating of beverages can result in delayed eruptive boiling; therefore take care when handling the container with the heated beverage.

The contents of **baby bottles and baby food** jars should be shaken or stirred and their temperature checked before feeding in order to avoid burns.

Eggs in their shell should **not be heated** in microwave ovens since they may explode even after microwave heating has ended.

**If you observe smoke**, switch off or unplug the appliance and keep the oven door closed in order to stifle any flames.

**Always use oven mitts** to remove dishes from the oven. Some pots, pans, or trays absorb the heat of foods and therefore become very hot.

**Make sure** to only use the cookware that is suitable for use in a microwave oven. Do not use cookware made of steel or cookware with golden or silver rims.

**Do not leave any accessories or utensils** in your oven when it is off. To avoid damage, do not switch on an empty oven.

**Do not use** receptacles made of porcelain, ceramics, or clay, if there are pores in the material or if the inside is not glazed. Once heated up, the moisture that would penetrate these pores could cause cracking. Only use the cookware intended for use in a microwave oven.

**Always read** and observe the instructions for heating in a microwave oven, specified on the food packaging.

**Be careful** when heating alcohol-containing food, as a combustible mixture of alcohol and air may form inside the oven. Open the door carefully.

**When using the microwave** or the combined microwave and convection functions, use of metallic cookware, forks, spoons, knives or metal clips/fasteners for frozen food is not recommended. After heating, stir the food or leave it to rest until the heat is evenly distributed.

**Regularly clean the oven** and remove any food residues. Failure to maintain cleanliness in the oven may result in deterioration of its surfaces. This can negatively affect the useful life of the appliance and lead to potentially dangerous situations.

## BEFORE CONNECTING THE OVEN:



Carefully read the instructions for use before connecting the appliance. Repair or any warranty claim resulting from incorrect connection or use of the appliance shall not be covered by the warranty.

# BEFORE USING THE APPLIANCE FOR THE FIRST TIME

Remove all equipment, accessories, and utensils from the oven and clean them with warm water and regular detergent. Do not use any abrasive cleaners.

Before using the oven for the first time, heat it with the upper and lower heater system at 200 °C for approximately one hour. The characteristic "new appliance" scent will be released; make sure the room is well ventilated.

## MICROWAVE FUNCTION

Microwaves are used for cooking, roasting, and defrosting of food. They allow quick and efficient cooking without changing the colour or shape of the food.

Microwaves are a type of electromagnetic radiation. Such radiation is commonly found in our environment in the form of radio-electric waves, light or infrared rays. Their frequency is in the 2,450 MHz range.

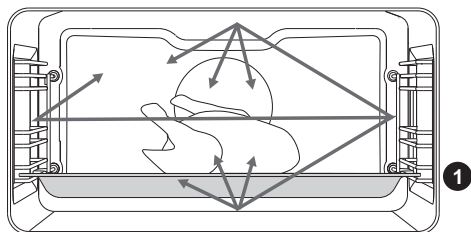

Their behaviour:

- They are reflected by metals.
- They travel through all other materials.
- They are absorbed by water, fat and sugar molecules.

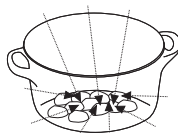
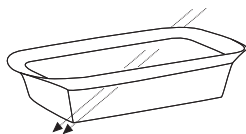

When food is exposed to microwaves, the molecules begin to move rapidly, thereby generating heat.

The microwaves penetrate approximately 2.5 centimeters deep into the food. If the food is thicker, the core of the food will be cooked by conduction, as in conventional cooking.



**Never use or activate a microwave system if the oven is empty.**

# SWITCHING ON THE APPLIANCE FOR THE FIRST TIME

## SETTING THE CLOCK

After connecting your appliance or after an extended power outage, 12:00 will flash on the display.

Set the time of day.



Confirm each setting by pressing the KNOB.



Press the KNOB to set the time.



Turn the KNOB and first set the TICK.



The oven will also work if the clock is not set. However, timer functions are not available in this case (see chapter **SETTING THE TIMER FUNCTIONS**). After a few minutes of idling, the appliance will switch to standby mode.

## CHANGING THE CLOCK SETTING

Clock settings may be changed when no timer function is activated (see chapter **CHOOSING THE GENERAL SETTINGS**).

## SELECTING THE LANGUAGE

If you are not happy with the language in which the messages on the display are presented, select another one. English is the preset language.



Rotate the KNOB and select your language from the list. CONFIRM the selection. The main menu will appear.

# STEPS OF THE COOKING PROCESS (1-7)

---

## STEP 1: CHOOSING THE BASIC COOKING MENUS AND SETTINGS

The process of preparing food in your oven can be controlled in several ways:

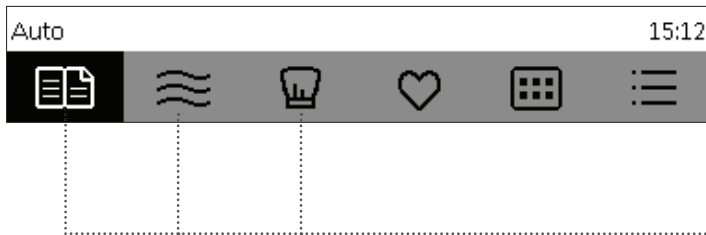

Rotate the KNOB and select the symbol. The symbol will turn white. The NAME of the selected menu will appear at the top.



Confirm each setting by pressing the KNOB.



### Automatic mode

In this mode, first select the type of food. This is followed by automatic setting of the quantity, level of doneness, and cooking end time.

The program offers a large choice of preset recipes reviewed by professional chefs and nutrition experts.



### Microwaves

This mode is suitable for cooking, roasting, and defrosting of food.



### Professional mode

Use this mode when you wish to prepare any type and amount of food. All settings are selected by the user.



## A) COOKING BY SELECTING THE TYPE OF FOOD (Auto mode)

 Confirm each setting by pressing the KNOB.



Rotate the KNOB and select the Auto mode. Confirm the setting by pressing on the KNOB.





Select the type of food and the dish. Confirm the selection.



Preset values will appear. Rotate the KNOB and confirm by pressing the KNOB to change these settings.

- 1 Amount
- 2 Doneness
- 3 Delayed start
- 4 Cooking duration
- 5 Cooking system and recommended level

 In preheating and in microwave systems, the timer function - delayed start is not available.

 When in the **Auto mode**, choose the duration or system symbol to open the Professional mode (see section on COOKING BY SELECTING THE OPERATING MODE).

Touch the START/STOP key to start oven operation.  
All selected settings are indicated on the display.

## PREHEAT

Some dishes in the Auto mode also include the preheat function 

When you select the food, the following note will appear: **"Selected program includes preheating." Preheating started.** Do not insert the food yet. The symbol °C will flash on the display.

When the selected temperature is reached, the preheating process stops and an acoustic signal is emitted.

The following note will appear on the display: **"Preheating complete"**. Please insert the food. Open the door or confirm by pressing the KNOB. The program then resumes the cooking process with selected settings.



When the preheat function is set, delayed start function cannot be used.

## B) COOKING WITH MICROWAVES

 Confirm each setting by pressing the KNOB.



Rotate the KNOB and select Microwaves. Confirm the selection by pressing on the KNOB.

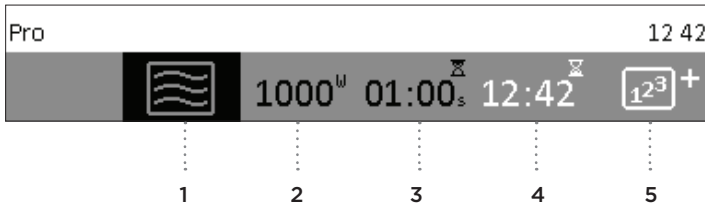

Select the settings by rotating the KNOB and pressing it to confirm.



- 1 Microwave system
- 2 Operating power / temperature (for combined systems)
- 3 Cooking duration
- 4 Delayed start
- 5 Step mode (see section STEP COOKING)

In microwave systems, the timer function – delayed start is not available.

Touch the START/STOP key to start oven operation.

Selected settings and the time counting down will be displayed on the display unit.

 If you selected a combined system with microwaves, the symbol °C will flash until the set temperature is reached.

COOKING SYSTEMS	DESCRIPTION	PRESET TEMPERATURE (°C)	POWER (W)
<b>COMBINED SYSTEMS / MICROWAVE SYSTEMS</b>			
	<b>MICROWAVE SYSTEMS</b> Microwaves are used for cooking and defrosting. They allow quick and efficient cooking without changing the colour or shape of the food.	-	1000
	<b>HOT AIR AND MICROWAVES</b> Use this for all types of meat, stews, vegetables, pies, cakes, bread, and dishes au gratin (i.e. food that require longer cooking time).	160	600
	<b>GRILL WITH FAN + MICROWAVES</b> Use this combination for smaller chunks of meat, fish and vegetables. It allows fast cooking and the food will have a nicely browned crispy crust.	200	600

POWER LEVEL	USE
1000 W	<ul style="list-style-type: none"> <li>• Quickly reheating beverages, water and dishes containing a large volume of liquid.</li> <li>• Cooking dishes with high water content (soups, sauces etc.).</li> </ul>
750 W	<ul style="list-style-type: none"> <li>• Cooking fresh or frozen vegetables.</li> </ul>
600 W	<ul style="list-style-type: none"> <li>• Melting chocolate.</li> <li>• Cooking fish and seafood; reheating on two levels.</li> <li>• Cooking dried beans at low heat.</li> <li>• Reheating and cooking of delicate egg-based dishes.</li> </ul>
360 W	<ul style="list-style-type: none"> <li>• Low-heat cooking of dairy products or jams.</li> </ul>
180 W	<ul style="list-style-type: none"> <li>• Manual defrosting; softening butter or ice cream.</li> </ul>
90 W	<ul style="list-style-type: none"> <li>• Defrosting cream-filled pastry.</li> </ul>

## C) COOKING BY SELECTING THE OPERATING MODE (Professional mode)

 Confirm each setting by pressing the KNOB.



Rotate the KNOB and select **Professional (Pro) mode**. Confirm the selection.

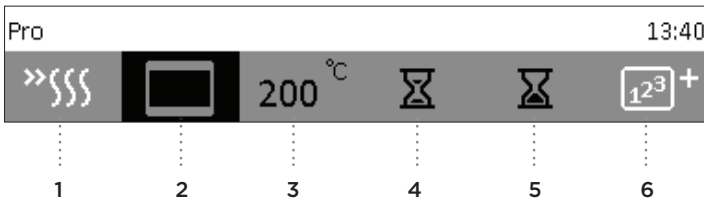

Select the settings by rotating the KNOB and pressing it to confirm.

- 1 Preheating
- 2 System
- 3 Oven temperature
- 4 Cooking duration
- 5 Delayed start
- 6 Step cooking









### PREHEAT



Use the preheat function  if you wish to heat the oven to the desired temperature as quickly as possible. When this symbol is selected, the preheat function will be switched on and a warning will appear. **"Preheating started."** Do not insert the food yet. The symbol °C will flash on the display.

When the selected temperature is reached, the preheating process stops and an acoustic signal is emitted. The following note will appear on the display: **"Preheating complete"**. Please insert the food. Open the door or confirm by pressing the KNOB. The program then resumes the cooking process with selected settings.

 When the preheat function is set, delayed start function cannot be used.

## COOKING SYSTEMS (depending on the model)

SYSTEM	DESCRIPTION	PRESET TEMPERATURE (°C)	MIN - MAX TEMPERATURE (°C)
<b>COOKING SYSTEMS</b>			
	<b>UPPER AND BOTTOM HEATER</b> The heaters in the bottom and in the ceiling of the oven cavity will radiate heat evenly into the oven interior. Pastry or meat can only be baked/roasted at a single height level.	200	30 - 250
	<b>UPPER HEATER</b> Only the heater on the oven cavity ceiling will radiate heat. Use this heater to brown the upper side of the dish.	150	30 - 235
	<b>BOTTOM HEATER</b> Only the heater on the bottom of the oven cavity will radiate heat. Use this heater to brown the lower side of the dish.	160	30 - 235
	<b>GRILL</b> Only grill heater, a part of the large grill set, will operate. Use this heater to grill a few open sandwiches or beer sausages, or for toasting bread.	240	30 - 250
	<b>LARGE GRILL</b> The upper heater and the grill heater will operate. The heat is radiated directly by the grill heater installed in the oven ceiling. To boost the heating effect, the upper heater is activated as well. This system is used for grilling a smaller amount of open sandwiches or beer sausages, and for toasting bread.	240	30 - 250
	<b>GRILL WITH FAN</b> Grill heater and the fan will operate. This combination is used to grill meat and to roast larger chunks of meat or poultry at a single height level. It is also appropriate for dishes au gratin and for browning to a crispy crust.	170	30 - 250
	<b>HOT AIR AND BOTTOM HEATER</b> Bottom heater, round heater, and the fan will operate. This is used to bake pizza, moist pastry, fruitcakes, leavened dough and shortcrust on several levels simultaneously.	200	30 - 250
	<b>3D HOT AIR</b> Round heater and the fan will operate. The fan installed in the back wall of the oven cavity makes sure the hot air constantly circulates around the roast or pastry. This mode is used for roasting meat and baking pastry at several levels simultaneously.	180	30 - 250
	<b>ECO COOKING <sup>1)</sup></b> In this mode, power consumption during the cooking process is optimized. This mode is used for roasting meat and baking pastry.	180	-

SYSTEM	DESCRIPTION	PRESET TEMPERATURE (°C)	MIN - MAX TEMPERATURE (°C)
<b>COOKING SYSTEMS</b>			
	<b>BOTTOM HEATER AND FAN</b> This is used for baking leavened but low-rising pastry and for preserving fruit and vegetables.	180	30 - 230
	<b>AUTOMATIC COOKING OF MEAT - AUTO ROAST MODE</b> In the Auto Roast mode/system, the upper heater will operate in combination with the grill heater and the round heater. It is used for roasting all types of meat.	180	30 - 240

<sup>1)</sup> It is used for determining the energy efficiency class pursuant to the EN 60350-1 standard.

Touch the START key to start oven operation.  
 All selected settings are indicated on the display.

 The symbol °C will flash on the display until the selected temperature is reached. A short beep will be heard. Cooking/baking systems cannot be changed during operation.

## STEP 2: TIMER FUNCTIONS - DURATION

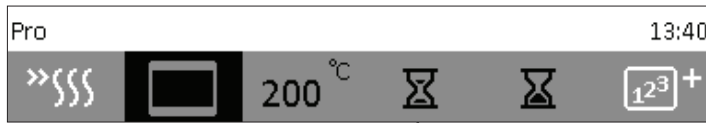

The "Duration" setting can be selected in the basic Professional (Pro) mode.

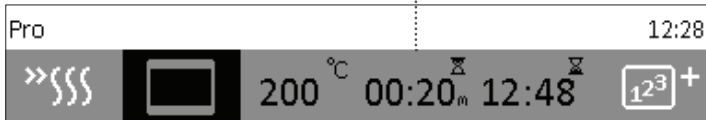

Cooking duration

Delayed start



### Setting the cooking time

In this mode, you can define the duration of oven operation (cooking time). Set the desired cooking time and confirm the setting. Cooking end time is adjusted accordingly.

Press START to start the cooking process. All selected settings are indicated on the display.

All timer functions can be cancelled by setting the time to "0".



### Setting the delayed start

In this mode, you may specify the duration of the cooking process (cooking time) and the time when you wish the cooking process to stop (end time) (Delayed start function allows delaying the start by up to 24 hours.). Make sure the clock is accurately set to current time.

Example:

Current time: 12:00

Cooking duration: 2 hours

End of cooking: 6 pm

First, set the cooking time (COOKING DURATION), i.e. 2 hours. The sum of the current time and cooking time is automatically displayed (2 pm).

How, set the COOKING END TIME and set the time (6 PM). Press START to start the COOKING process. The timer will wait for the start of the cooking process. The following note will appear on the display:

**"Cooking start is delayed. Cooking will start at 16:00."**



After the set time expires, the oven will automatically stop operating (end of cooking). An acoustic signal will be heard which you may turn off by pressing the ALARM key. After one minute, the acoustic signal will be switched off automatically.

After a few minutes of idling, the appliance will switch to standby mode. The time of day will appear.



# STEP 3: STEP COOKING

This mode allows you to combine three different cooking modes successively in a single cooking process.

Choose different settings to cook your food just the way you want it.

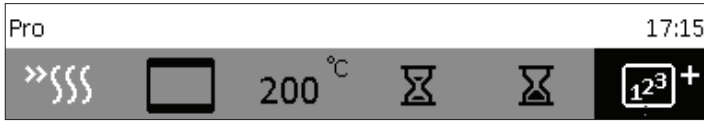

The **"Step cook"** setting can be selected in the basic Professional (Pro) mode and microwaves. Confirm the setting by pressing on the KNOB.



Select: step 1, step 2, step 3  
Confirm the settings by pressing on the KNOB.



The first step will already have been selected if you have already set the timer functions.

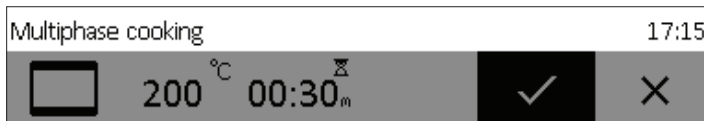

Set the cooking system, temperature, and time. Confirm the setting with the CHECK MARK by pressing on the KNOB.





Total cooking time - end.

Current step

Temperature and duration of the selected step

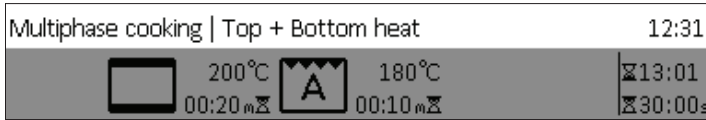
Touch the START symbol to turn on the oven. The oven starts operating immediately, with the settings defined in Step 1. (A strip at the bottom of the display indicates the cooking step currently in progress.) After the set cooking time elapses, Step 2 and then Step 3 are activated, if specified.



 If you wish to delete a step during operation, turn the KNOB, choose the step and cancel it by confirming the X mark. This can only be done with steps that have not started yet.

## STEP 4: START THE COOKING PROCESS

The START/STOP key will flash before the start of the cooking process.

Start the cooking process by briefly touching the START/STOP key.  
Rotate the KNOB to change the current settings during cooking.



## STEP 5: END THE COOKING PROCESS AND SWITCHING OFF THE OVEN

For a pause in the cooking process, press the START/STOP key and hold it for a while.

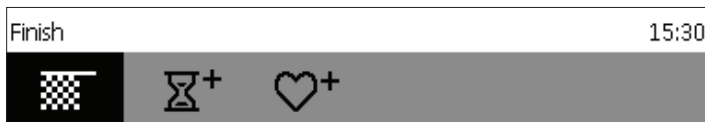

Turn the KNOB to display the **End** menu with a display of symbols.



### End!

Select the icon and complete the cooking process. Main menu will appear on the display.



### Extend the cooking time

Cooking time can be extended by selecting the icon. New cooking end time can be selected (see chapter TIMER FUNCTIONS).



### Add to my recipes

This mode allows you to save the selected settings into the oven memory and use them again at a later time.

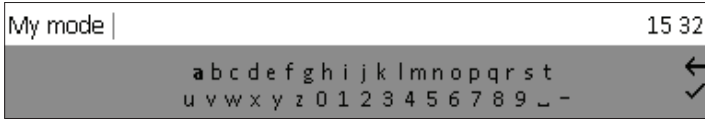

## SAVING USER-DEFINED PROGRAMS (MY RECIPES)



Choose the symbol  and enter the name by rotating the KNOB and confirming respective letters. If necessary, delete a character using the arrow; use the check mark or touch the START/STOP key to confirm the name. Select the type of food.



Select the type of food. Press the KNOB to save your settings.

 Your favourite recipes that you have previously stored in the memory can be retrieved and used at any time. Choose the process and the settings in the main menu by selecting the  symbol.

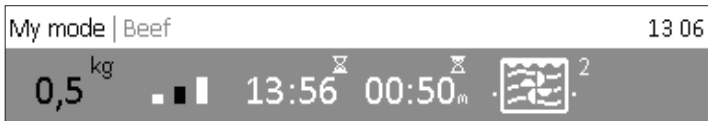

Preset values will appear which you can still change.

Confirm and touch the START key to start the oven operation.

 Up to 10 recipes can be stored in the memory.

### DELETING A RECIPE

Select the recipe to be deleted. Press and hold the KNOB to delete the recipe; an acoustic signal will be sounded.

# STEP 6: SELECTING ADDITIONAL FUNCTIONS



Choose **Extra** in the main menu to display the extra/additional function menu.

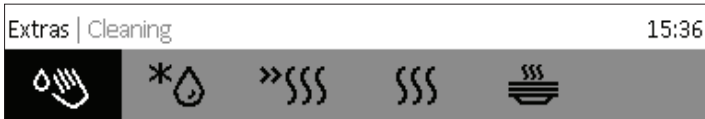

Some functions are not available with some systems; an acoustic signal will indicate such cases.



## Aqua clean

Use it to remove stains. Pour 0.6 l water into the deep baking tray and place it in the lower guide. After 30 minutes, food residues on the enamel surfaces will have softened and they will be easy to wipe off with a damp cloth.

Use this function when the oven has fully cooled down! (See chapter CLEANING AND MAINTENANCE.)



## Defrosting

In this mode, the air will circulate without any heaters operating. Only the fan will be activated. Use this function to slowly defrost frozen food (cakes, pastry, bread, rolls, and deep-frozen fruit). By selecting the relevant symbol you may specify the type of food, weight, or defrosting start and end time.

Halfway through the defrost time, the pieces should be turned over, stirred and separated if they were frozen together.



## Quick preheat

Use the preheat function if you wish to heat the oven to the desired temperature as quickly as possible. This mode is not appropriate for cooking. When the oven heats up to the selected temperature, the preheat process is completed and the oven is ready for cooking with the selected cooking mode.



## Reheating

Reheating can be used to keep the food that is already cooked warm. Select the symbol to set the temperature, and reheating start and end time.



## Plate heating

Use this function to reheat your dinnerware (plates, cups) before serving food in it to keep the food warm longer. Select the symbol to set the temperature, and reheating start and end time.

Add to my mode

13:48



Turn the KNOB to display the **End** menu with a display of symbols.



## CHILD LOCK

Activate it by touching the LOCK key (key symbol). The following message will appear on the display: **"Child lock activated."** Touch the key again to deactivate the child lock.



If the child lock is activated with no timer function engaged (only clock is displayed), then the oven will not operate. If the child lock is activated after a timer function has been set, then the oven will operate normally; however, it will not be possible to change the settings.

When the child lock is activated, systems (cooking modes) or additional functions cannot be changed. Only the cooking/baking/roasting process can be stopped or switched off.

Child lock remains active after the oven is switched off. To select a new system, the child lock must first be deactivated.



## OVEN LIGHTING

Oven lighting is switched on automatically when the door is opened or when the oven is switched on.

After the end of the cooking process or when the door is closed, the light will remain on for another minute.

The light inside the oven can be switched on or off by pressing the LIGHT key.



## SETTING THE MINUTE MINDER

The minute minder can be used independently of the oven operation. Activate it by pressing the key. The longest possible setting is 10 hours. When the time expires, an acoustic signal will be heard which you may turn off by touching any key. After one minute, the acoustic signal will be switched off automatically.

# STEP 7: CHOOSING THE GENERAL SETTINGS



Choose **Settings** in the main menu to display the menu for various settings.



Rotate the KNOB to navigate the menu. Confirm each setting by pressing the KNOB.

## Language

Select the language for the text on the display.

## Time

Set the time of day after the appliance is connected to the power mains for the first time or after being disconnected from the power mains for a longer period of time (more than one week). Set the CLOCK - time. Set the display mode in the "Time Design" field: digital or analogue.

## Sound

Loudness of the acoustic signal can be set when no timer function is activated (only the time of day is displayed). In this menu, you can set the following: **loudness**.



## Display

In this menu, you can set the following:

### Lighting

**Night mode** - specify the time until which you wish the display to be dimmed.





## Setting during the cooking process

In this menu, you can set the following:

**Oven lighting during operation** - oven lighting is switched off when oven door is opened during operation.

## Other settings

Factory settings



After a power outage or after switching off the appliance, all extra user settings are restored.

# DESCRIPTIONS OF SYSTEMS (COOKING MODES) AND COOKING TABLES

---

If your desired food cannot be found in the cooking table, find information for similar food. The information displayed applies to cooking in a single level.

An interval of suggested temperature is indicated. Start with a lower temperature setting and increase it if you find the food is not browned sufficiently.

Cooking times are rough estimates and may vary subject to some conditions.

Only **preheat the oven** if required by the recipe or in the tables in this instruction manual. Heating an empty oven consumes a lot of energy. Hence, baking several types of pastry or several pizzas successively will save a lot of energy as the oven will already have been preheated.

Use dark, black silicon-layered or enamel-coated baking sheets and trays as they conduct the heat very well.

When using parchment paper, make sure it is resistant to high temperatures.

When cooking larger chunks of meat or pastry, a lot of steam will be generated inside the oven, which in turn may condense on the oven door. This is a normal phenomenon which will not affect the operation of the appliance. After the cooking process, wipe the door and the door glass dry.

**Switch off the oven** approximately 10 minutes before the end of the cooking process to save energy by making use of the accumulated heat (this does not apply to systems with microwaves).

Do not cool the food in a closed oven to prevent condensation (dew).



**The asterisk (\*) in the table means the oven should be preheated with the selected system.**

# COOKING SYSTEMS

## UPPER AND BOTTOM HEATER

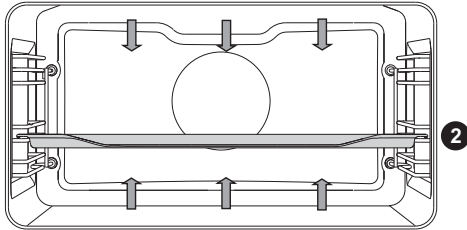

The heaters in the bottom and in the ceiling of the oven cavity will radiate heat evenly into the oven interior.

### Roasting meat:

Use enamel coated, tempered glass, clay, or cast iron pan or tray. Stainless steel trays are not suitable as they strongly reflect the heat.

Use enamel coated, tempered glass, clay, or cast iron pan or tray. Stainless steel trays are not suitable as they strongly reflect the heat.

Type of food	Weight (g)	Guide (from the bottom)	Temperature (°C)	Cooking time (min)
<b>MEAT</b>				
Pork roast	1500	1	180-200	90-120
Pork shoulder	1500	1	180-200	110-140
Pork roulade	1500	2	180-200	90-110
Roast beef	1500	1	170-190	120-150
Veal roulade	1500	2	180-200	80-100
Lamb sirloin	1500	1	180-200	60-80
Rabbit loin	1000	2	180-200	50-70
Deer shank	1500	1	180-200	90-120
Meat rolls	/	2	180-200	15-30
<b>FISH</b>				
Braised fish	200 g/piece	2	190-210	40-50

## Baking pastry

Only use one level and dark baking sheets or trays. In light-coloured baking sheets or trays, the browning of the pastry will be poorer, as such equipment will reflect the heat. Always place the baking trays on the grid. If you are using the supplied baking sheet, remove the grid. Cooking time will be shorter if the oven is preheated.

Type of food	Guide (from the bottom)	Temperature (°C)	Cooking time (min)
<b>PASTRY</b>			
White bread, 1 kg *	2	220	10-15
		180-190	30-40
Buckwheat bread, 1 kg *	2	180-190	50-60
Whole grain bread, 1 kg *	2	180-190	50-60
Rye bread, 1 kg *	2	180-190	50-60
Spelt bread, 1 kg *	2	180-190	50-60
Sweet soufflé	2	170-190	40-50
Bread rolls *	2	190-210	20-30
Walnut cake	1	170-180	50-60
Sponge cake *	1	160-170	30-40
Macarons (meringue pastry)	2	130-150	15-25
Vegetable rolls	2	190-200	25-35
Fruit rolls	2	190-200	25-35
Small pastries made with yeast dough	2	200-210	20-30
Cabbage pirozhki *	2	190-200	25-35
Fruitcake	1	130-150	80-100
Meringue cookies	2	80-90	110-130
Jelly-filled rolls (Buchtel)	2	170-180	30-40

Tip	Use
<b>Is the cake done?</b>	<ul style="list-style-type: none"> <li>• Pierce the cake at the top with a wooden toothpick or skewer. If there are no traces on the pick or the skewer when pulled out, the cake is done.</li> </ul>
<b>Did the cake collapse?</b>	<ul style="list-style-type: none"> <li>• Check the recipe.</li> <li>• Next time, use less liquid.</li> <li>• Note the mixing time when using small mixers, blenders etc.</li> </ul>
<b>The cake is too light at the bottom?</b>	<ul style="list-style-type: none"> <li>• Use a dark-coloured baking sheet or tray.</li> <li>• Place the baking sheet one guide lower and switch on the lower heater towards the end of the cooking progress.</li> </ul>
<b>Cake with moist stuffing is underdone?</b>	<ul style="list-style-type: none"> <li>• Increase temperature and extend baking time.</li> </ul>



**Do not insert the deep baking tray into the first guide.**

## LARGE GRILL, GRILL

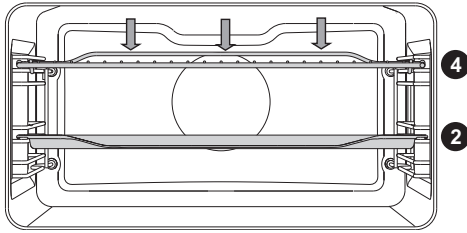

When grilling food with the large grill, the upper heater and the grill heater fitted on the ceiling of the oven cavity will operate.

2 When grilling with normal (not large) grill, only grill heater, a part of the large grill set, will operate.

Preheat the infrared (grill) heater for five minutes.

Supervise the cooking process at all times. The meat may burn quickly due to high temperature.

Roasting with the grill heater is suitable for crispy and low-fat cooking of bratwurst, cuts of meat and fish (steaks, escalopes, salmon steaks or fillets etc.) or toasted bread.

When grilling directly on the grid, smear it with oil to prevent the meat from sticking onto it and insert it into the 4th guide. Insert the drip tray in to the 1st or 2nd guide. When grilling in a baking tray, make sure there is enough liquid in the tray to prevent burning. Turn the meat during cooking.

After grilling, clean the oven, the accessories, and the utensils.

### Grilling table - small grill

Type of food	Weight (g)	Guide (from the bottom)	Temperature (°C)	Cooking time (min)
<b>MEAT</b>				
Beefsteak, rare	180 g/piece	3	240	20-25
Pork neck fillet	150 g/piece	3	240	25-30
Cutlets/chops	280 g/piece	3	240	30-35
Grill sausages	70 g/piece	3	240	20-25
<b>TOASTED BREAD</b>				
Toast	/	3	240	5-10
Open sandwiches	/	3	240	5-10

## Grilling table - large grill

Type of food	Weight (g)	Guide (from the bottom)	Temperature (°C)	Cooking time (min)
<b>MEAT</b>				
Beefsteak, rare	180 g/piece	3	240	10-15
Beefsteak, well done	180 g/piece	3	240	15-20
Pork neck fillet	150 g/piece	3	240	15-20
Cutlets/chops	280 g/piece	3	240	20-25
Veal escalope	140 g/piece	3	240	15-20
Grill sausages	70 g/piece	3	240	10-20
Spam (Leberkäse)	150 g/piece	3	240	15-20
<b>FISH</b>				
Salmon steaks/fillets	200 g/piece	3	240	15-20
<b>TOASTED BREAD</b>				
6 slices of bread	/	3	240	1-4
Open sandwiches	/	3	240	2-5



Always keep the oven door closed when using the grill (infrared) heater.

Grill heater, grid, and other oven accessories get very hot during grilling. Therefore, use oven mitts and meat tongs.

## GRILL WITH FAN

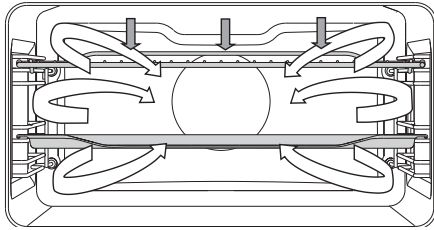

In this operating mode, the grill heater and the fan operate simultaneously. Suitable for grilling meat, fish, and vegetables.

4

2

(See descriptions and tips for GRILL.)

Type of food	Weight (g)	Guide (from the bottom)	Temperature (°C)	Cooking time (min)
<b>MEAT</b>				
Duck	2000	1	180-200	90-110
Pork roast	1500	1	170-190	90-120
Pork shoulder	1500	1	160-180	100-130
Half of chicken	700	1	190-210	50-60
Chicken	1500	1	200-220	60-80
Meat loaf	1500	1	160-180	70-90
<b>FISH</b>				
Trout	200 g/piece	2	200-220	20-30



## HOT AIR AND BOTTOM HEATER

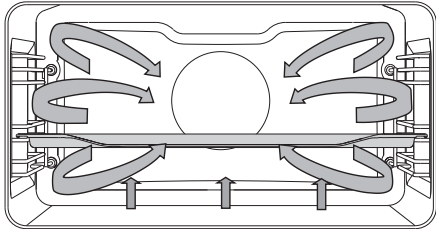

The bottom heater, the round heater, and the hot air fan will operate. Suitable for baking pizzas, apple pies, and fruitcakes.

2 (See descriptions and tips for UPPER and BOTTOM HEATER.)

Type of food	Guide (from the bottom)	Temperature (°C)	Cooking time (min)
Cheesecake, short crust	2	160-170	60-70
Pizza *	2	220-230	10-15
Quiche Lorraine, shortcrust	1	200-210	50-60
Apple strudel, phyllo dough	2	180-190	50-60

## 360 HOT AIR

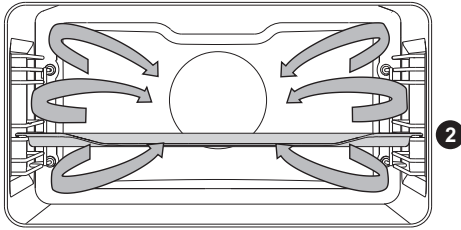

Round heater and the fan will operate. The fan installed in the back wall of the oven cavity makes sure the hot air constantly circulates around the roast or pastry.

### Roasting meat:

Use enamel coated, tempered glass, clay, or cast iron pan or tray. Stainless steel trays are not suitable as they strongly reflect the heat.

Provide enough liquid during the cooking process to prevent the meat from burning. Turn the meat during roasting. The roast will remain juicier if you cover it.

Type of food	Weight (g)	Guide (from the bottom)	Temperature (°C)	Cooking time (min)
<b>MEAT</b>				
Pork roast, including skin	1500	1	170-190	90-120
Chicken, whole	1500	2	180-200	70-90
Duck	2000	1	170-190	120-150
Chicken breast	1000	2	190-210	50-60
Stuffed chicken	1500	1	190-210	110-130

## Baking pastry

Preheating is recommended.

Biscuits and cookies can be baked in shallow baking sheets on several levels simultaneously (2nd and 3rd).

Note that baking time can differ even with if the baking sheets used are the same. The biscuits in the upper baking sheet may be ready sooner than those in the lower one.

Always place the baking trays on the grid. If you are using the supplied baking sheet, remove the grid.

For even browning, make sure the biscuits are of the same thickness.

Type of food	Guide (from the bottom)	Temperature (°C)	Cooking time (min)
<b>PASTRY</b>			
Sponge cake	1	160-170	30-40
Crumble cake	2	170-180	25-35
Plum cake	1	160-170	30-40
Sponge roll *	2	170-180	15-25
Fruit cake, short crust	1	170-180	50-70
Challah (braided yeast bun)	2	170-180	35-50
Apple strudel	2	180-190	50-60
Pizza *	2	210-220	15-20
Biscuits, short crust *	2	160-170	15-25
Biscuits, pressed *	2	150-160	20-30
Small cakes *	2	150-160	20-30
Cookies, leavened	2	180-190	20-35
Cookies, phyllo dough	2	180-190	20-30
Cream-filled pastry	2	190-200	25-45
<b>FROZEN PRODUCTS</b>			
Apple and cottage cheese strudel	2	180-190	55-70
Pizza	2	190-200	20-35
Fried potatoes, oven-ready	2	210-220	25-40
Croquettes, oven-baked	2	210-220	20-35



**Do not insert the deep baking tray into the first guide.**

## ECO COOKING

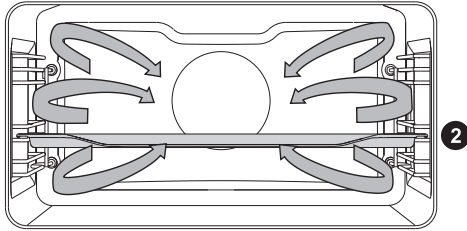

Round heater and the fan will operate. The fan installed in the back wall of the oven cavity makes sure the hot air constantly circulates around the roast or pastry.

Type of food	Guide (from the bottom)	Temperature (°C)	Cooking time (min)
<b>MEAT</b>			
Pork roast, 1 kg	1	200-210	110-130
Pork roast, 2 kg	1	200-210	130-150
Beef roast, 1 kg	1	210-220	100-120
<b>FISH</b>			
Whole fish, 200 g/piece	2	200-210	40-50
Fish fillet, 100 g/piece	2	210-220	25-35
<b>PASTRY</b>			
Pressed cookies	2	180-190	20-30
Small cupcakes	2	190-200	30-35
Sponge roll	2	200-210	15-25
Fruit cake, short crust	1	190-200	55-65
<b>VEGETABLE</b>			
Potatoes au gratin	2	190-200	40-50
Lasagne	2	200-210	45-55
<b>FROZEN PRODUCTS</b>			
Pommes frites, 1 kg	2	230-240	35-45
Chicken medallions, 0.7 kg	2	220-230	30-40
Fish sticks, 0.6 kg	2	220-230	30-40



**Do not insert the deep baking tray into the first guide.**

## BOTTOM HEATER AND FAN

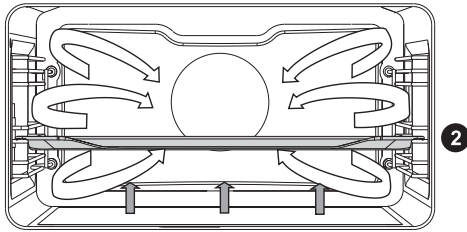

This is used for baking leavened but low-rising pastry and for preserving fruit and vegetables. Use the second guide from the bottom and a rather shallow baking tray to allow the hot air to circulate across the upper side of the dish.

## PRESERVATION

Prepare the food to be preserved and jars as usual. Use jars with a rubber sealing ring and a glass cover. Do not use jars with threaded or metal caps or metal tins. Make sure the jars are of equal size, filled with the same contents, and tightly sealed.

Pour 1 litre of hot water into the deep tray (approx. 70°C) and place 6 1-litre jars into the tray. Place the tray into the oven on the second guide.

During preservation, observe the food and cook until the liquid in the jars starts to simmer – when bubbles appear in the first jar.

Type of food	Guide (from the bottom)	Temperature (°C)	Cooking time (min)	Temperature at the start of simmering	Resting time in the oven (min)
<b>FRUIT</b>					
Strawberries (6×1 l)	2	180	40-60	switch off	20-30
Stone fruits (6×1 l)	2	180	40-60	switch off	20-30
Fruit mush (6×1 l)	2	180	40-60	switch off	20-30
<b>VEGETABLE</b>					
Pickled gherkins (6×1 l)	2	180	40-60	switch off	20-30
Beans/carrots (6×1 l)	2	180	40-60	120 °C, 60 min	20-30

## AUTOMATIC COOKING OF MEAT - AUTO ROAST MODE

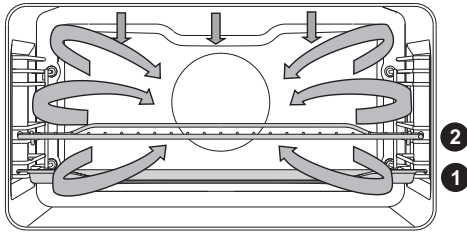

In the Auto Roast mode, the upper heater will operate in combination with the grill heater and the round heater. It is used for roasting all types of meat.

When grilling directly on the grid, smear it with oil to prevent the meat from sticking onto it and insert it into the 2nd guide. Insert a drip tray into the 1st guide. When roasting meat in a baking tray, insert it into the 1st guide.

Type of food	Weight (g)	Guide (from the bottom)	Temperature (°C)	Cooking time (min)	Core temperature (°C)
Beef tenderloin	1000	2	170-190	60-80	55-75*
Chicken, whole	1500	2	180-200	65-85	85-90
Turkey	4000	2	170-190	150-180	85-90
Pork roast	1500	2	170-190	100-120	70-85
Meat loaf	1000	2	170-190	50-65	80-85
Veal	1000	2	170-190	70-90	75-85
Lamb	1000	2	180-200	50-70	75-85
Venison	1000	2	180-200	60-90	75-85
Whole fish	1000	2	170-190	40-50	75-85
Chicken thighs	1000	2	190-210	45-55	85-90

# MICROWAVE SYSTEMS

## MICROWAVES

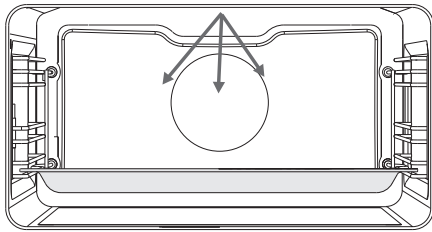

Microwaves are used for cooking and defrosting.

Power levels: 90, 180, 360, 600, 750, 100 W.

- 1 Place the glass baking dish into the 1st guide.

## Defrosting

Type of food	Weight (g)	Power (W)	Defrosting time (min)
<b>MEAT</b>			
Minced meat **	500	90	35-45
Meat in pieces **	500	90	20-30
Steaks **	500	90	20-30
Whole pieces of meat **	1000	90	70-80
Poultry portions **	500	90	25-35
Whole fish **	200	90	15-20
<b>PASTRY</b>			
Bread **	1000	90	20-25
Bread rolls **	500	90	10-15
Walnut cake **	500	90	15-25
Fruit cake **	500	90	15-25
<b>FRUIT AND VEGETABLE</b>			
Fruit	500	90	15-25
Vegetable	500	90	20-30

## Reheating

Type of food	Weight (g)	Power (W)	Defrosting time (min)
<b>FOOD</b>			
Steaks	300 g	600	3-5
Whole fish	200 g	600	3-5
Mixed vegetable *	500 g	600	3-5
Side dishes *	500 g	600	3-5
Sauces *	500 g	600	2-4
Soups/stews *	5 dl	750	2-4
Pizza	500 g	600	2-4
Chicken medallions	500 g	600	2-4
Open sandwiches	/	600	2-4
Popcorn	90 g	1000	2-4
Melting chocolate	100 g	600	2-4
Butter softening	250 g	180	2-4
Baby bottle	2 dl	360	3-4
Baby food	4 dl	180	2-3
<b>BEVERAGE</b>			
Water	2 dl	1000	1-2
Coffee	2 dl	1000	1-2
Mulled wine	2 dl	1000	1-2
Milk	2 dl	1000	1-2



## Cooking

Type of food	Weight (g)	Power (W)	Cooking time (min)
<b>MEAT</b>			
Chicken thighs **	1000	600	20-30
Chicken wings **	1000	600	15-25
Chicken braised in sauce *	500	1000	15-25
Chicken - whole **	1500	600	45-60
Pork roast **	1000	600	45-60
Pork chops **	500	750	25-35
Steaks **	500	1000	10-20
Meat loaf	700	600	25-35
Meatballs *	1000	1000	10-20
Fish **	200	600	15-20
<b>DESSERTS</b>			
Chocolate soufflé	6	360	12-17
Cheese soufflé	glass baking dish	750	15-20
Fruit purée	glass baking dish	750	12-17
Custard creams	glass baking dish	360	23-28

Type of food	Weight (g)	Water addition	Power (W)	Cooking time (min)
<b>VEGETABLE</b>				
Potatoe	500	1 tablespoons/100 g	1000	13-18
Eggplant / aubergines	500	1 tablespoons/100 g	600	13-18
Courgettes	500	1 tablespoons/100 g	360	10-15
Carrots	500	1 tablespoons/100 g	1000	10-15
Onions	200	1 tablespoons/100 g	1000	5-10
String beans	500	1 tablespoons/100 g	750	10-15
Broccoli	1000	1 tablespoons/100 g	750	10-15
Bell peppers	500	1 tablespoons/100 g	1000	8-13
Cauliflower	1000	1 tablespoons/100 g	750	18-23
Leeks	200	1 tablespoons/100 g	1000	10-15
Brussels sprout	500	1 tablespoons/100 g	1000	10-15

Type of food	Weight (g)	Water addition	Power (W)	Cooking time (min)
Button mushrooms / Champignons	500	1 tablespoons/100 g	1000	10-15
Asparagus	500	1 tablespoons/100 g	750	5-10
Peas	500	1 tablespoons/100 g	750	25-30
Cabbage	500	1 tablespoons/100 g	750	15-20

#### SIDE DISHES

Rice	200	Ratio food to liquid 1:2	750	15-20
Pasta	200	Ratio food to liquid 1:2	750	10-15
Whole grain pasta	200	Ratio food to liquid 1:2	1000	10-15
Oatmeal	500	Ratio food to liquid 1:2	1000	5-10
Brown rice	200	Ratio food to liquid 1:2	750	25-30
Risotto	500	Ratio food to liquid 1:2	750	20-25
Couscous	250	Ratio food to liquid 1:2	1000	3-8
Polenta	250	Ratio food to liquid 1:3	1000	5-10
Millet	250	Ratio food to liquid 1:3	1000	10-15

Type of food	Weight (g)	Power (W)	Cooking time (min)
<b>FROZEN PRODUCTS</b>			
Meat loaf	700	600	35-45
Chicken - whole **	1500	600	55-65
Pork roast **	1000	600	50-60
Chicken medallions **	500	750	10-15
Mixed vegetable *	500	750	10-20
Fish **	200	600	10-15

## COMBINED SYSTEMS

### HOT AIR AND MICROWAVES

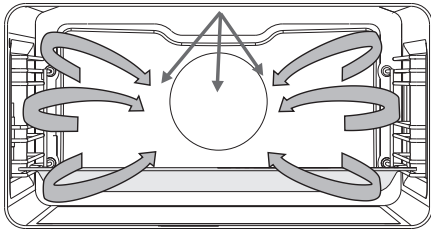

In this cooking mode, the food is cooked with a combination of microwaves and grill.

Power levels: 90, 180, 360, 600 W

Place the glass baking dish into the 1st guide.

Type of food	Weight (g)	Power (W)	Temperature (°C)	Cooking time (min)
Poultry	1000	360	200-220	35-45
Poultry	Half	360	190-200	25-35
Chicken thighs	1000	600	190-200	20-30
Duck	1500	360	190-200	45-60
Poultry wings	500	600	190-200	15-20

# GRILL WITH FAN + MICROWAVES

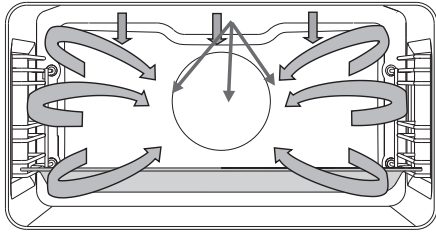

This system uses a combination of microwaves and grill with fan to cut the cooking time.

Power levels: 90, 180, 360, 600 W.

**1** Place the baking tray into the 1st guide.

Type of food	Weight (g)	Power (W)	Temperature (°C)	Cooking time (min)
<b>MEAT</b>				
Veal roast	1500	360	180-190	70-90
Lamb ribs	1500	360	180-190	50-60
Meat loaf	1000	360	180-190	40-50
Poultry breast	500	360	180-200	25-35
Duck breast	1000	360	200-210	25-35
Pork roast	1500	600	180-190	60-80
Roasted beef	1500	600	180-190	60-80
Chicken, whole	1500	360	200-210	45-60
Chicken, half	1500	360	200-210	35-45
Chicken thighs	1000	360	200-210	35-45
<b>PASTRY</b>				
Strudel - sweet	/	600	180-200	15-20
<b>VEGETABLE</b>				
Cannelloni	/	600	180-200	15-20
Ukrainian cabbage rolls	/	750	180-200	25-35
Potatoes au gratin	800	600	180-200	25-35



**When using microwave systems, do not use metal cookware or utensils.**

**Do not preheat the oven.**

# MAINTENANCE & CLEANING



Be sure to unplug the appliance from the power supply and wait for the appliance to cool down.

Children should not clean the appliance or perform maintenance tasks without proper supervision.

## Aluminium finish

Clean the aluminium finish with non-abrasive liquid cleaners intended for such surfaces. Apply the cleaner onto a wet cloth and clean the surface. Then, rinse the surface with water. Do not apply the cleaner directly onto the aluminium finish.

Do not use abrasive cleaners or sponges.

Note: The surface should not come into contact with oven cleaning sprays as this may result in visible and permanent damage.

## Stainless steel sheet front side of the housing

(depending on the model)

Clean this surface only with a mild detergent (soapsuds) and a soft sponge that will not scratch the finish. Do not use abrasive cleaners or cleaners containing solvents as they may damage the housing finish.

## Lacquer-coated surfaces and plastic parts

(depending on the model)

Do not clean the knobs and buttons, door handles, stickers, and rating/type plates with abrasive cleaners or abrasive cleaning materials, alcohol-based cleaners, or with alcohol. Immediately remove any stains with a soft non-abrasive cloth and some water, in order to avoid damaging the surface.

You may also use cleaners and cleaning materials intended for such surfaces as instructed by their respective manufacturers.

## Appliance door

The door is attached to the appliance and may not be removed. Also, the door may not be disassembled or otherwise tapered with.



The aluminium-coated surfaces should not come into contact with oven cleaning sprays as this may result in visible and permanent damage.

# CONVENTIONAL OVEN CLEANING

You may use the standard cleaning procedure to clean stubborn dirt in the oven (using cleaners or an oven spray). After such cleaning, rinse the cleaner residues thoroughly.

Clean the oven and the accessories after each use to prevent the dirt from burning into the surface. The easiest way to remove fat is by using warm soapsuds while the oven is still warm.

With stubborn dirt and grime, use conventional oven cleaners. Rinse the oven thoroughly with clean water to remove all cleaner residue.

Never use aggressive cleaners, abrasive cleaners, abrasive sponges, stain and rust removers etc.

Clean the accessories (baking sheets and trays, grids etc.) with hot water and detergent.

The oven, the oven cavity and the baking trays are lined with a special enamel coating for a smooth and resistant surface. This special coating makes cleaning at room temperature easier.

# USING THE AQUA CLEAN FUNCTION TO CLEAN THE OVEN

Pour 0.6 l of water into a glass or shallow baking dish and insert it into the lower guide.

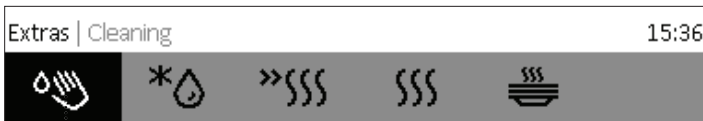

Choose "Extra/Additional Functions" in the main menu and select the Aqua Clean symbol.

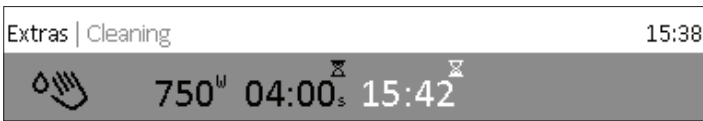

Press the START key.

 After 4 minutes, food residues on the oven enamel walls will have softened and they will be easy to clean with a damp cloth.



**Use the Aqua Clean function when the oven has fully cooled down.**

# REMOVING AND CLEANING THE WIRE GUIDES

Only use conventional cleaners to clean the guides.

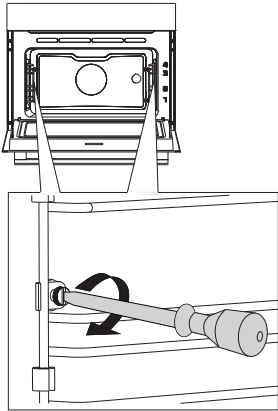

**1** Undo the screw. Use a screwdriver.

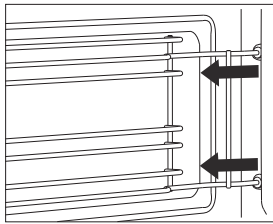

**2** Remove the guides from the holes in the back wall.

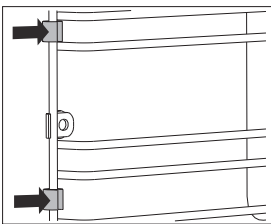

Take care not to lose the spacers fitted on the wire guides. Replace the spacers after cleaning; otherwise, sparks may appear.



After cleaning, re-tighten the screws on the guides with a screwdriver.

When replacing the wire guides, make sure you mount them on the same side they were installed on prior to removal.

# REPLACING THE BULB

The bulb is a consumable and therefore not covered by warranty. Before changing the bulb, remove the trays, the grid, and the guides.

Use a Phillips (cross) screwdriver.  
(Halogen lamp: G9, 230 V, 25 W)

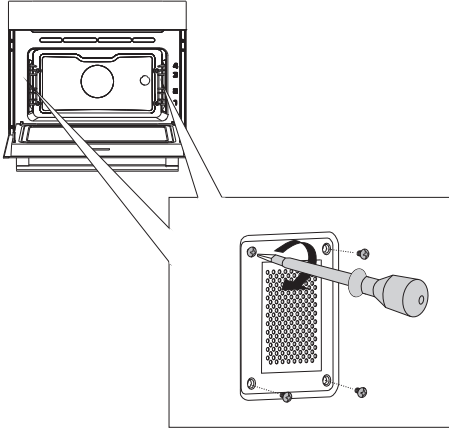

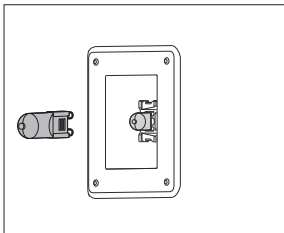

- 1 Undo the four screws on the cover.  
Remove the cover and the glass.

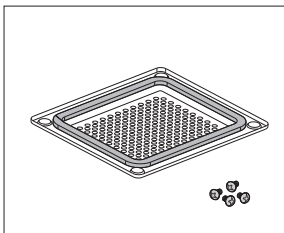

- 2 Remove the halogen light bulb and replace it with a new one.

 Use protection to avoid burns.



 There is a gasket on the cover which should not be removed. Do not allow the gasket to be detached from the cover. The gasket should fit correctly onto the oven cavity wall.



**Firmly re-tighten the screws on the cover using a screwdriver; otherwise, sparks may appear.**



# TROUBLESHOOTING TABLE

Problem/error	Cause
<b>There is no response of the sensors; the display is frozen.</b>	Disconnect the appliance from the power mains for a few minutes (undo the fuse or switch off the main switch); then, reconnect the appliance and switch it on.
<b>The main fuse in your home trips often.</b>	Call a service technician.
<b>The oven lighting does not work.</b>	The process of changing the light bulb is described in the chapter. Cleaning and Maintenance.
<b>The pastry is underdone.</b>	Did you choose the right temperature and heating system? Is the oven door closed?
<b>Error code is displayed: ERRXX ... * XX denotes the number/code of the error.</b>	There is an error in the electronic module operation. Disconnect the appliance from the power mains for a few minutes. Then, reconnect it and set the time of day. If the error is still indicated, call a service technician.
<b>Sparks appear in the oven.</b>	Make sure all covers of the lights are fastened and that all spacers are fitted on the wire guides. Make sure the guides are correctly placed in the appliance.

If the problems persist despite observing the advice above, call an authorized service technician. Repair or any warranty claim resulting from incorrect connection or use of the appliance shall not be covered by the warranty. In this case, the user will cover the cost of repair.



**Before the repair, disconnect the appliance from the power mains (by removing the fuse or by removing the plug from the wall outlet).**

# DISPOSAL

---



Packaging is made of environmentally friendly materials that can be recycled, disposed of, or destroyed without any hazard to the environment. To this end, packaging materials are labelled appropriately.

The symbol on the product or its packaging indicates that the product should not be treated as normal household waste. The product should be taken to an authorized collection center for waste electric and electronic equipment processing.













Correct disposal of the product will help prevent any negative effects on the environment and health of people which could occur in case of incorrect product removal. For detailed information on removal and processing of the product, please contact the relevant municipal body in charge of waste management, your waste disposal service, or the store where you bought the product.

*We reserve the right to any changes and errors in the instructions for use.*

# COOKING TEST



Food tested in compliance with the EN 60350-1 standard.

## Conventional baking

Dish	Equipment	Guide (from the bottom)	Temperature (°C)	Cooking time (min)	System
Shortbread - single level	Shallow enamel-coated baking sheet	2	140-150 *	25-40	
Shortbread - single level	Shallow enamel-coated baking sheet	2	140-150 *	25-40	
Shortbread - two levels	Shallow enamel-coated baking sheet	2, 3	140-150 *	25-40	
Cupcakes - single level	Shallow enamel-coated baking sheet	2	140-150 *	20-35	
Cupcakes - single level	Shallow enamel-coated baking sheet	2	150-160 *	20-35	
Cupcakes - two levels	Shallow enamel-coated baking sheet	2, 3	140-150 *	30-45	
Sponge cake	Round metal mould, diameter 26 cm/Wire shelf	1	160-170 *	20-35	
Sponge cake	Round metal mould, diameter 26 cm/Wire shelf	1	160-170 *	20-35	
Apple pie	2 x round metal mould, diameter 20 cm/Wire shelf	1	170-180	65-85	
Apple pie	2 x round metal mould, diameter 20 cm/Wire shelf	2	160-170	65-85	
Sponge cake	Round metal mould, diameter 26 cm/Wire shelf	2	150-160	10	
					





\* Preheat for 10 minutes. Do not use fast preheat function.

## Grilling



Dish	Equipment	Guide (from the bottom)	Temperature (°C)	Cooking time (min)	SYSTEM
Toast	Wire shelf	4	230 *	1:00-3:00	
Beefburgers	Wire shelf + baking sheet as drip tray	3	230 *	25-35 **	

\* Preheat for 10 minutes. Do not use fast preheat function.

## Microwave cooking

Dish	Equipment	Guide (from the bottom)	Power (W)	Cooking time (min)	System
Egg custard, 1000 g	Glass container, dimension 25x25 cm, uncovered + glass baking dish	1	360	23-28	
Sponge cake	Round glass container, diameter 22 cm, uncovered + glass baking dish	1	360	22-25	
Meatloaf, 900 g	Glass container, dimensions 25x12.5 cm, uncovered + glass baking dish	1	600	10	
			Defrost meat (minced meat), 500 g	12-15	
Defrost meat (minced meat), 500 g	Glass baking dish	1	180	8	
			90	15-17	
Defrosting raspberries, 250 g	Glass container, uncovered + glass baking dish	1	180	7-7.30	

## Combined microwave cooking

Dish	Equipment	Guide (from the bottom)	Temperature (°C)	Power (W)	Cooking time (min)	System
Potato gratin	Round glass container, diameter 22 cm, uncovered + glass baking dish	1	190	600	25-30	
Cake	Round glass container, diameter 22 cm, uncovered + glass baking dish	1	180	180	22-25	
Chicken (1,2 kg)*	Glass container, uncovered + glass baking dish	1	210-220	360	45-55	

## Degrees of doneness for meat

TYPE OF MEAT	Core temperature (°C)
<b>BEEF</b>	
Raw	40-45
Rare	55-60
Medium	65-70
Well done	75-80
<b>VEAL</b>	
Well done	75-85
<b>PORK</b>	
Medium	65-70
Well done	75-85
<b>LAMB</b>	
Well done	79
<b>MUTTON</b>	
Raw	45
Rare	55-60
Medium	65-70
Well done	80
<b>GOAT MEAT</b>	
Medium	70
Well done	82
<b>POULTRY</b>	
Well done	82
<b>FISH</b>	
Well done	65-70



---

**gorenje<sup>+</sup>**



489563