

---

# **gorenje<sup>+</sup>**

**DETAILED INSTRUCTIONS  
FOR USE OF MICROWAVE  
OVEN**



---

We thank you for your trust and the purchase of our appliance.

This detailed instruction manual is supplied to make the use of this product easier. The instructions should allow you to learn about your new appliance as quickly as possible.

Make sure you have received an undamaged appliance. If you do find transport damage, please contact the seller from which you purchased the appliance, or the regional warehouse from which it was supplied. The telephone number can be found on the invoice or on the delivery note.

Instructions for installation and connection are supplied on a separate sheet.

Instructions for use are also available at our website:

[www.gorenje.com](http://www.gorenje.com) / < <http://www.gorenje.com> />



Important information



Tip, note

# CONTENTS

<b>4 MICROWAVE OVEN</b> 7 Technical specifications 8 Control unit (depending on the model) ..... <b>10 IMPORTANT SAFETY INSTRUCTIONS</b> 13 Before connecting the oven:	<b>INTRODUCTION</b>
<b>14 BEFORE USING THE APPLIANCE FOR THE FIRST TIME</b> ..... <b>15 SWITCHING ON THE APPLIANCE FOR THE FIRST TIME</b>	<b>PREPARING THE APPLIANCE FOR THE FIRST USE</b>
<b>16 STEPS OF THE COOKING PROCESS (1-7)</b> 16 Step 1: CHOOSING THE BASIC COOKING MENUS AND SETTINGS 19 Step 2: TIMER FUNCTIONS - DURATION 20 Step 3: STEP COOKING 22 Step 4: START THE COOKING PROCESS 22 Step 5: END THE COOKING PROCESS AND SWITCHING OFF THE OVEN 24 Step 6: SELECTING ADDITIONAL FUNCTIONS 26 Step 7: CHOOSING THE GENERAL SETTINGS ..... <b>28 DESCRIPTIONS OF SYSTEMS (COOKING MODES) AND COOKING TABLES</b>	<b>COOKING STEPS</b>
<b>33 MAINTENANCE &amp; CLEANING</b> 34 CONVENTIONAL OVEN CLEANING 34 USING THE AQUA CLEAN FUNCTION TO CLEAN THE OVEN 35 REMOVING AND CLEANING THE WIRE GUIDES 36 REPLACING THE BULB	<b>MAINTENANCE &amp; CLEANING</b>
<b>37 TROUBLESHOOTING TABLE</b> ..... <b>38 DISPOSAL</b>	<b>TROUBLE-SHOOTING</b>
<b>39 COOKING TEST</b>	<b>OTHER</b>

# MICROWAVE OVEN

## (DESCRIPTION OF THE OVEN AND EQUIPMENT - DEPENDING ON THE MODEL)

The figure represents one of the built-in appliance models. Since the appliances for which these instructions were drawn up may have different equipment, some functions or equipment may be described in the manual that may not be present in your appliances.

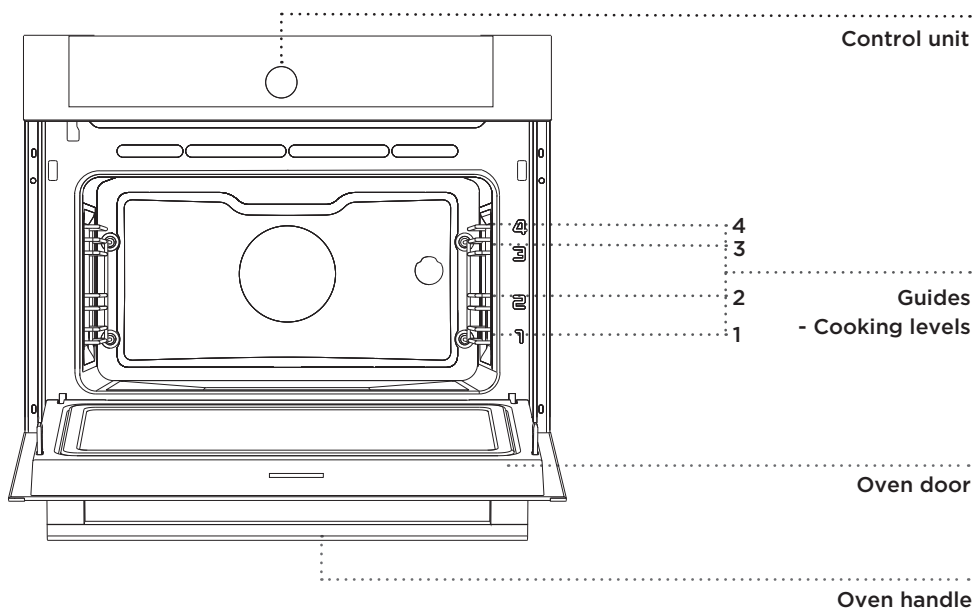

## **WIRE GUIDES**

The wire guides allow preparation of the food on four levels (please note that the levels/guides are counted from the bottom up).

## **OVEN DOOR SWITCH**

The switches deactivate the microwave heating when the oven door is opened during the cooking process. When the door is closed, the switches turn the microwaves back on.

## **COOLING FAN**

The appliance is fitted with a cooling fan that cools the housing and the appliance control panel.

## **EXTENDED OPERATION OF THE COOLING FAN**

After the oven is switched off, the cooling fan continues to operate for a short while in order to provide additional cooling for the oven. (Extended operation of the cooling fan depends on microwave operation time.)

## OVEN EQUIPMENT AND ACCESSORIES

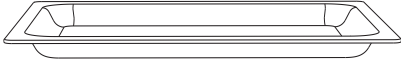

Use the **GLASS BAKING DISH** for cooking with microwaves. It can also be used as a serving tray.

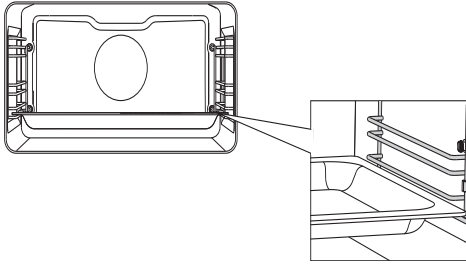

In case of wire guides, the tray should always be inserted into the groove between the two wire profiles.



**Never use the grid, the shallow baking sheet or the deep baking tray or any other metal part or accessory when operating a system with microwaves!**

# TECHNICAL SPECIFICATIONS

(DEPENDING ON THE MODEL)

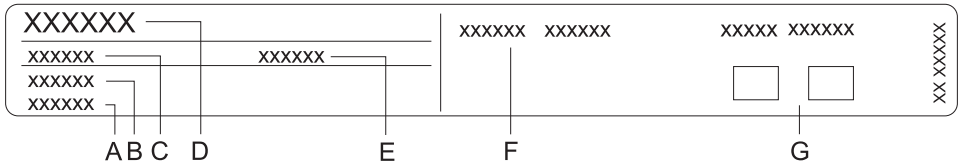

- A Serial number
- B Code/ID
- C Type
- D Brand
- E Model
- F Technical data
- G Compliance symbols

The rating plate indicating the basic information about the appliance is located at the edge of the oven and it is visible when the oven door is opened.

# CONTROL UNIT

(Depending on the model)

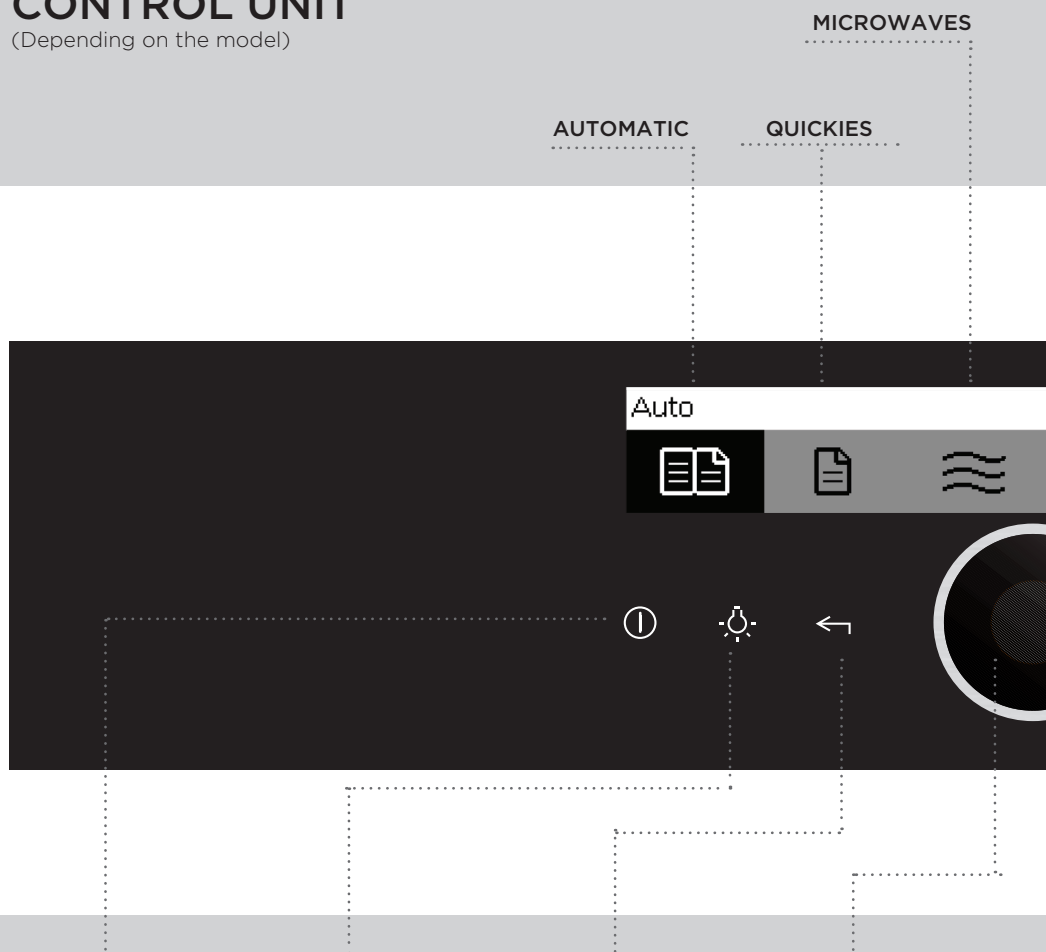

**1** ON/OFF KEY

**2** OVEN  
LIGHTING ON/  
OFF KEY

**3** BACK KEY

**4** Selection and  
CONFIRMATION  
KNOB

Touch briefly to return to previous menu.

Touch and hold to return to main menu.

Select the setting by rotating the knob.

Confirm your selection by pressing the knob.



MY RECIPES

EXTRA  
FUNCTIONS

GENERAL  
SETTINGS

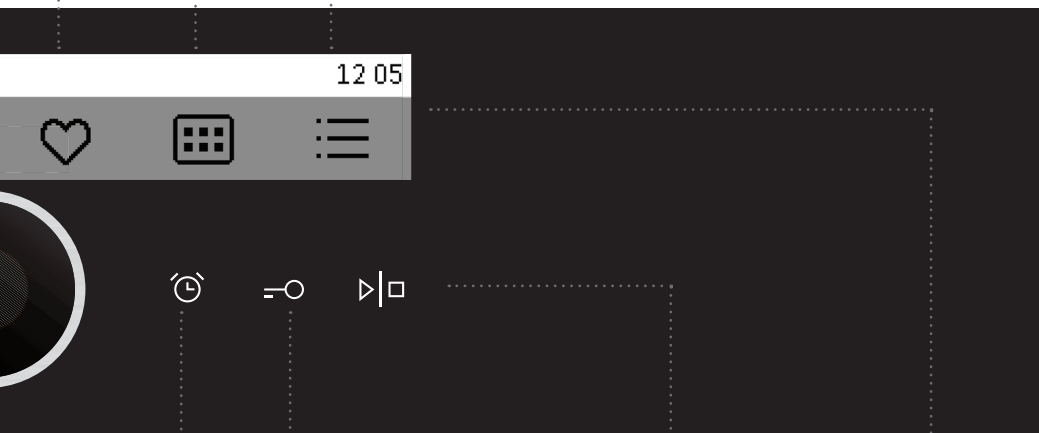

**5** MINUTE  
MINDER/  
ALARM

**6** CHILD LOCK  
KEY  
Locking the control  
unit

**7** START/STOP  
KEY  
Long touch: START

**8** DISPLAY - displays  
all settings

Long touch during  
operation: STOP

**NOTE:**

The keys will respond better if you touch them with a larger area of your fingertip. Each time you press a key, this will be acknowledged by a short acoustic signal.

# IMPORTANT SAFETY INSTRUCTIONS

---



**CAREFULLY READ THE INSTRUCTIONS AND SAVE THEM FOR FUTURE REFERENCE.**

This appliance may only be used by children aged 8 years and above and persons with reduced physical, sensory or mental capabilities or lack of experience and knowledge if supervision or instructions are provided to them concerning use of the appliance in a safe way and if they understand the hazards involved. Do not let the children play with the appliance. Cleaning and user maintenance shall not be made by children without supervision.

**WARNING:** The appliance and some of its accessible parts may become very hot during use. Be careful not to touch the heaters. Children younger than 8 years should be constantly supervised.

The appliance becomes very hot during use. Be careful not to touch the oven heaters.

**WARNING:** The accessible parts of the appliance may become hot during use. Children should be kept away from the oven.

Only use the temperature probe recommended for use in this oven.

**WARNING:** Before replacing the light bulb, make sure the appliance has been disconnected from the power mains, in order to prevent the hazard of an electric shock.

Do not use abrasive cleaners or sharp metal scrapers to clean the oven as they may damage the finish or the protective enamel coating. Such damages may lead to cracking of the glass.

Do not use steam cleaners or high pressure cleaners to clean the appliance as this may result in an electric shock.

The appliance is not intended to be controlled with external timers or special control systems.

The appliance is intended for household use. Do not use it for any other purpose, such as room heating, drying of pets or other animals, paper, fabrics, herbs etc. as this may lead to injury or fire hazard.

If the power cords of other appliances located near this appliance are caught in the oven door, they may be damaged, which may in turn result in a short circuit. Therefore, keep the power cords of other appliances at a safe distance.

If the power cord is damaged, it should be replaced by the manufacturer or an authorized service technician, in order to avoid hazard.

Do not line the oven walls with aluminium foil and do not place baking trays or other cookware on the oven bottom. Aluminium foil would prevent air circulation in the oven, hinder the cooking process, and ruin the enamel coating.

Oven door become very hot during operation. A third glass is installed for extra protection, reducing the temperature of the outside surface (only with some models).

Oven door hinges may be damaged when under excessive load. Do not place heavy pans on open oven door and do not lean against open oven door when cleaning the oven cavity. Never stand on the open oven door and do not let children to sit on it.

Appliance operation is safe with and without tray guides.

Make sure the vents are never covered or obstructed in any other way.

## Safe use of the microwave oven

**WARNING:** If your oven allows combined operation (microwaves combined with other cooking modes), do not allow the children to use the oven without supervision of an adult person since the oven will reach very high temperatures in such operation modes.

**WARNING:** If the door or door sealing is damaged, do not use the oven until it is repaired by an adequately trained service technician.

**WARNING:** It is hazardous for anyone other than a competent person to carry out any service or repair operation which involves removal of the cover that protects against exposure to microwave radiation.

**WARNING:** Liquids and other foods must not be heated in sealed containers since they are liable to explode.

Heed the minimum distance between the upper edge of the oven and the nearest object above it.

The appliance is intended for use in households and similar environments, such as:

- staff pantries in stores and other working environments;
- family farms;
- accommodation units for guests at hotels, motels, and other accommodation or lodging establishments;
- bed and breakfast establishments.

The microwave oven is intended for heating food and beverages. Drying food or clothing and heating of hot packs or pads, slippers, sponges, moist cloths etc. may result in injury, ignition, or fire.

Only use utensils suitable for use in microwave ovens.

When heating food in plastic or paper containers, keep an eye on the oven as such packaging may ignite.

Microwave heating of beverages can result in delayed eruptive boiling; therefore take care when handling the container with the heated beverage.

The contents of baby bottles and baby food jars should be shaken or stirred and their temperature checked before feeding in order to avoid burns.

Eggs in their shell should not be heated in microwave ovens since they may explode even after microwave heating has ended.

If you observe smoke, switch off or unplug the appliance and keep the oven door closed in order to stifle any flames.

Always use oven mitts to remove dishes from the oven. Some pots, pans, or trays absorb the heat of foods and therefore become very hot.

Make sure to only use the cookware that is suitable for use in a microwave oven. Do not use cookware made of steel or cookware with golden or silver rims.

Do not leave any accessories or utensils in your oven when it is off. To avoid damage, do not switch on an empty oven.

Do not use receptacles made of porcelain, ceramics, or clay, if there are pores in the material or if the inside is not glazed. Once heated up, the moisture that would penetrate these pores could cause cracking. Only use the cookware intended for use in a microwave oven.

Always read and observe the instructions for heating in a microwave oven, specified on the food packaging.

Be careful when heating alcohol-containing food, as a combustible mixture of alcohol and air may form inside the oven. Open the door carefully.

When using the microwave or the combined microwave and convection functions, use of metallic cookware, forks, spoons, knives or metal clips/fasteners for frozen food is not recommended. After heating, stir the food or leave it to rest until the heat is evenly distributed.

Regularly clean the oven and remove any food residues. Failure to maintain cleanliness in the oven may result in deterioration of its surfaces. This can negatively affect the useful life of the appliance and lead to potentially dangerous situations.

## BEFORE CONNECTING THE OVEN:



**Carefully read the instructions for use before connecting the appliance. Repair or any warranty claim resulting from incorrect connection or use of the appliance shall not be covered by the warranty.**

# BEFORE USING THE APPLIANCE FOR THE FIRST TIME

Upon receiving the appliance, remove all parts, including any transport equipment, from the oven. Clean all accessories and utensils with warm water and regular detergent. Do not use any abrasive cleaners.

Before using the oven for the first time, heat it with the upper and lower heater system at 200 °C for approximately one hour. The characteristic "new appliance" scent will be released; make sure the room is well ventilated.

## MICROWAVE FUNCTION

Microwaves are used for cooking, roasting, and defrosting of food. They allow quick and efficient cooking without changing the colour or shape of the food.

Microwaves are a type of electromagnetic radiation. Such radiation is commonly found in our environment in the form of radio-electric waves, light or infrared rays. Their frequency is in the 2,450 MHz range.

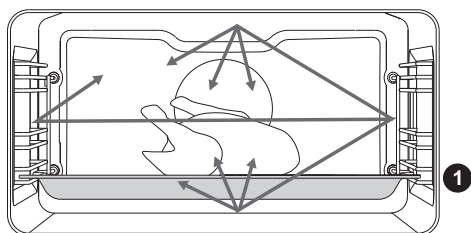

Their behaviour:

- They are reflected by metals.
- They travel through all other materials.
- They are absorbed by water, fat and sugar molecules.

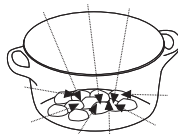
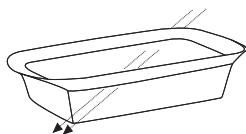

When food is exposed to microwaves, the molecules begin to move rapidly, thereby generating heat.

The microwaves penetrate approximately 2.5 centimeters deep into the food. If the food is thicker, the core of the food will be cooked by conduction, as in conventional cooking.



**Never use or activate a microwave system if the oven is empty.**

# SWITCHING ON THE APPLIANCE FOR THE FIRST TIME

---

## SETTING THE CLOCK

After connecting your appliance or after an extended power outage, 12:00 will flash on the display.

Set the time of day.

 Confirm each setting by pressing the KNOB.



Press the KNOB to set the time.



Turn the KNOB and first set the TICK.

 The oven will also work if the clock is not set. However, timer functions are not available in this case (see chapter Setting the Timer Functions). After a few minutes of idling, the appliance will switch to standby mode.

## CHANGING THE CLOCK SETTING

Clock settings may be changed when no timer function is activated (see chapter CHOOSING THE GENERAL SETTINGS).

## SELECTING THE LANGUAGE

If you are not happy with the language in which the messages on the display are presented, select another one. English is the preset language.



Rotate the KNOB and select your language from the list. CONFIRM the selection. The main menu will appear.

# STEPS OF THE COOKING PROCESS (1-7)

---

## STEP 1: CHOOSING THE BASIC COOKING MENUS AND SETTINGS

The process of preparing food in your oven can be controlled in several ways:

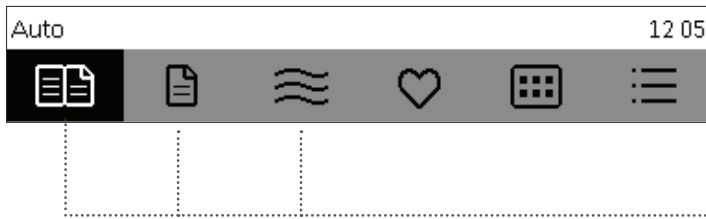

Rotate the KNOB and select the symbol. The symbol will turn white. The NAME of the selected menu will appear at the top.

 Confirm each setting by pressing the KNOB.



### Automatic mode

In this mode, first select **the type of food** and **the desired dish**. This is followed by automatic setting of the quantity and level of doneness.

The program offers a large choice of preset recipes reviewed by professional chefs and nutrition experts.



### Quickies

This mode offers a selection of preset cooking procedures for particular dishes. The cooking procedures can also be changed.



### Microwaves

This mode is suitable for cooking, roasting, and defrosting of food.



## A) COOKING BY SELECTING THE TYPE OF FOOD (Auto mode and Quickies mode)

 Confirm each setting by pressing the KNOB.



Rotate the KNOB and select the Auto mode. Confirm the setting by pressing on the KNOB.



Select the type of food and the dish. Confirm the selection.

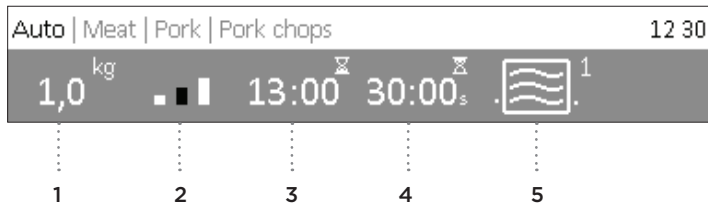

Preset values will appear. Rotate the KNOB and confirm by pressing the KNOB to change these settings.

- 1 Amount
- 2 Doneness
- 3 Delayed start
- 4 Cooking duration
- 5 Cooking system and recommended level

 When in the Auto and Rapid mode, choose the duration or system symbol to open the Professional mode (see section on COOKING BY SELECTING THE OPERATING MODE).

Touch the START/STOP key to start oven operation.  
All selected settings are indicated on the display.

## B) COOKING WITH MICROWAVES

 Confirm each setting by pressing the KNOB.



Rotate the KNOB and select Microwaves. Confirm the setting by pressing on the KNOB.



Select the settings by rotating the KNOB and pressing it to confirm.

1 2 3 4 5

- 1 Microwave system
- 2 Cooking power
- 3 Cooking duration
- 4 Delayed start
- 5 Step mode (see section STEP COOKING)

In microwave systems, the timer function – delayed start is not available.

Touch the START/STOP key to start oven operation.

Selected settings and the time counting down will be displayed on the display unit.

POWER LEVEL	USE
1000 W	<ul style="list-style-type: none"> <li>• Quickly reheating beverages, water and dishes containing a large volume of liquid.</li> <li>• Cooking dishes with high water content (soups, sauces etc.).</li> </ul>
750 W	<ul style="list-style-type: none"> <li>• Cooking fresh or frozen vegetables.</li> </ul>
600 W	<ul style="list-style-type: none"> <li>• Melting chocolate.</li> <li>• Cooking fish and seafood; reheating on two levels.</li> <li>• Cooking dried beans at low heat.</li> <li>• Reheating and cooking of delicate egg-based dishes.</li> </ul>
360 W	<ul style="list-style-type: none"> <li>• Low-heat cooking of dairy products or jams.</li> </ul>
180 W	<ul style="list-style-type: none"> <li>• Manual defrosting; softening butter or ice cream.</li> </ul>
90 W	<ul style="list-style-type: none"> <li>• Defrosting cream-filled pastry.</li> </ul>

## STEP 2: TIMER FUNCTIONS - DURATION

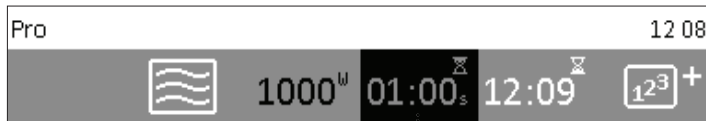

The "Duration" setting can be selected in the basic Microwave mode.

### Setting the cooking time

In this mode, you can define the duration of oven operation (cooking time). Set the desired cooking time and confirm the setting. (Maximum operating time is 10 hours.)

Cooking end time is adjusted accordingly.

Press START to start the cooking process. All selected settings are indicated on the display.

All timer functions can be cancelled by setting the time to "0".

 After the set time expires, the oven will automatically stop operating (end of cooking). An acoustic signal will be heard which you may turn off by pressing the ALARM key. After one minute, the acoustic signal will be switched off automatically.

After a few minutes of idling, the appliance will switch to standby mode. The time of day will appear.

# STEP 3: STEP COOKING

This mode allows you to combine three different cooking modes successively in a single cooking process.

Choose different settings to cook your food just the way you want it.

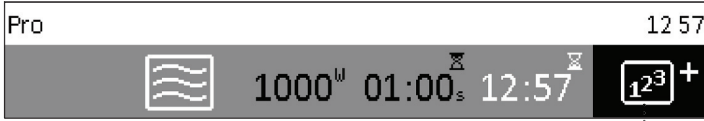

The "Step Cook" setting can be selected in the basic Microwave mode. Confirm the setting by pressing on the KNOB.

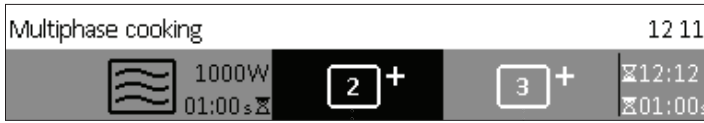

Select: Step 2, Step 3 Confirm the settings by pressing on the KNOB.



The first step is already selected.

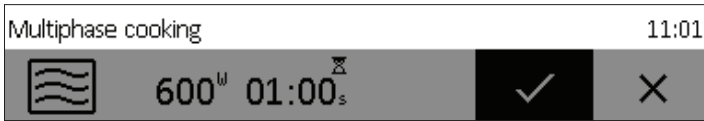

Set the cooking power and time. Confirm the selection with the check mark by pressing the KNOB.

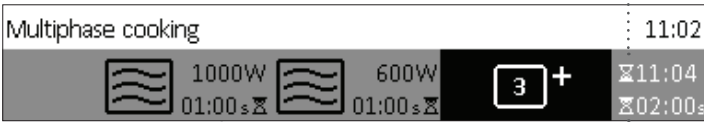

Total cooking time - end.

Current step

Cooking power and duration of the selected step

Touch the START symbol to turn on the oven. The oven starts operating immediately, with the settings defined in Step 1. (A strip at the bottom of the display indicates the cooking step currently in progress.) After the set cooking time elapses, Step 2 and then Step 3 are activated, if specified.



 If you wish to delete a step during operation, turn the KNOB, choose the step and cancel it by confirming the X mark. This can only be done with steps that have not started yet.

## STEP 4: START THE COOKING PROCESS

The START/STOP key will flash before the start of the cooking process.

Start the cooking process by briefly touching the START key.  
Rotate the KNOB to change the current settings during cooking.



## STEP 5: END THE COOKING PROCESS AND SWITCHING OFF THE OVEN

Start the cooking process by pressing the START/STOP key and holding it for a while.

When the cooking process is complete, the display will read: **"Program complete. Bon appétit!"**

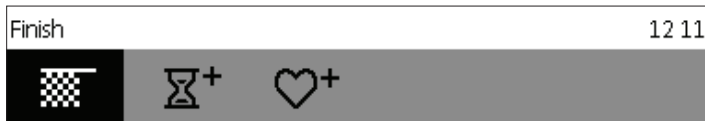

Turn the KNOB to display the End menu with a display of symbols.



### End!

Select the icon and complete the cooking process. Main menu will appear on the display.



### Extend the cooking time

Cooking time can be extended by selecting the icon. New cooking end time can be selected (see chapter Timer Functions).



### Add to my recipes

This mode allows you to save the selected settings into the oven memory and use them again at a later time.

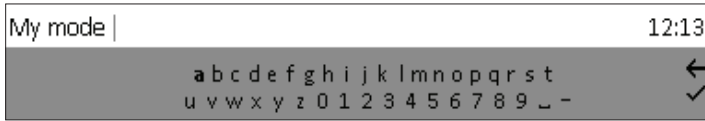

## SAVING USER-DEFINED PROGRAMS (MY RECIPES)

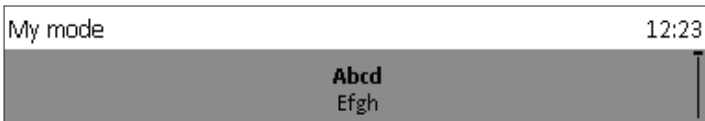

Choose the symbol  and enter the name by rotating the KNOB and confirming the KNOB and confirming respective letters. If necessary, delete a character using the arrow; use the check mark or touch the START/STOP key to confirm the name. Select the type of food.



Select the type of food. Press the KNOB to save your settings.

 Your favourite recipes that you have previously stored in the memory can be retrieved and used at any time. Choose the process and the settings in the main menu by selecting the  symbol.

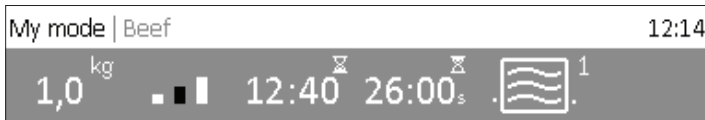

Preset values will appear which you can still change.

Confirm and touch the START key to start the oven operation.

 Up to 10 recipes can be stored in the memory.

### DELETING A RECIPE

Select the recipe to be deleted. Press and hold the KNOB to delete the recipe; an acoustic signal will be sounded.

# STEP 6: SELECTING ADDITIONAL FUNCTIONS



Choose Extra in the main menu to display the extra/additional function menu.



Some functions are not available with some systems; an acoustic signal will indicate such cases.



## Aqua clean

Use it to remove stains. Pour 0.6 l of water into a glass or shallow baking dish and insert it into the lower guide. After 4 minutes, food residues on the enamel surfaces will have softened and they will be easy to wipe off with a damp cloth.

Use this function when the oven has fully cooled down! (See chapter CLEANING AND MAINTENANCE.)



## Defrosting

In this mode, the air will circulate without any heaters operating.

Only the fan will be activated. Use this function to slowly defrost frozen food (cakes, pastry, bread, rolls, and deep-frozen fruit).

By selecting the relevant symbol you may specify the type of food, weight, or defrosting start and end time.

Halfway through the defrost time, the pieces should be turned over, stirred and separated if they were frozen together.

When the cooking process is complete, the display will read: "**Program complete. Bon appétit!**"



Turn the KNOB to display the **End** menu with a display of symbols.





## CHILD LOCK

Activate it by touching the LOCK key (key symbol). The following message will appear on the display: **"Child lock activated."** Touch the key again to deactivate the child lock.



If the child lock is activated with no timer function engaged (only clock is displayed), then the oven will not operate. If the child lock is activated after a timer function has been set, then the oven will operate normally; however, it will not be possible to change the settings.

When the child lock is activated, systems (cooking modes) or additional functions cannot be changed. Only the cooking/baking/roasting process can be stopped or switched off.

Child lock remains active after the oven is switched off. To select a new system, the child lock must first be deactivated.



## OVEN LIGHTING

Oven lighting is switched on automatically when the door is opened or when the oven is switched on.

After the end of the cooking process or when the door is closed, the light will remain on for another minute.

The light inside the oven can be switched on or off by pressing the LIGHT key.



## SETTING THE MINUTE MINDER

The minute minder can be used independently of the oven operation. Activate it by pressing the key. The longest possible setting is 10 hours. When the time expires, an acoustic signal will be heard which you may turn off by touching any key. After one minute, the acoustic signal will be switched off automatically.

# STEP 7: CHOOSING THE GENERAL SETTINGS



Choose Settings in the main menu to display the menu for various settings.



Rotate the KNOB to navigate the menu. Confirm each setting by pressing the KNOB.

## Language

Select the language for the text on the display.

## Time

Set the time of day after the appliance is connected to the power mains for the first time or after being disconnected from the power mains for a longer period of time (more than one week). Set the CLOCK - time. Set the display mode in the "Time Design" field: digital or analogue.

## Sound

Loudness of the acoustic signal can be set when no timer function is activated (only the time of day is displayed). In this menu, you can set the following: **loudness**.



## Display

In this menu, you can set the following:

### Lighting

**Night mode** - specify the time until which you wish the display to be dimmed.



## Setting during the cooking process

In this menu, you can set the following:

**Oven lighting during operation** - oven lighting is switched off when oven door is opened during operation.

## Other settings

Factory settings



After a power outage or after switching off the appliance, all extra user settings are restored.

# DESCRIPTIONS OF SYSTEMS (COOKING MODES) AND COOKING TABLES

---

If your desired food cannot be found in the cooking table, find information for similar food.

The information displayed applies to cooking in a single level.

Cooking times are rough estimates and may vary subject to some conditions.

When cooking larger chunks of meat, vegetables, or pastry, a lot of steam will be generated inside the oven, which in turn may condense on the oven door. This is a normal phenomenon which will not affect the operation of the appliance. After the cooking process, wipe the door and the door glass dry.

# MICROWAVE SYSTEMS

## MICROWAVES

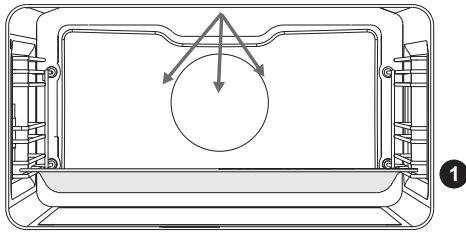

Microwaves are used for cooking and defrosting.

Power levels: 90, 180, 360, 600, 750, 100 W.

Place the glass baking dish into the 1st guide.

## Defrosting

Type of food	Weight (g)	Power (W)	Defrosting time (min)
<b>MEAT</b>			
Minced meat **	500	90	35-45
Meat in pieces **	500	90	20-30
Steaks **	500	90	20-30
Whole pieces of meat **	1000	90	70-80
Poultry portions **	500	90	25-35
Whole fish **	200	90	15-20
<b>PASTRY</b>			
Bread **	1000	90	20-25
Bread rolls **	500	90	10-15
Walnut cake **	500	90	15-25
Fruit cake **	500	90	15-25
<b>FRUIT AND VEGETABLE</b>			
Fruit	500	90	15-25
Vegetable	500	90	20-30

\*\* Turn halfway through the cooking process.

Separate individual pieces. After the end of the process, leave the food at room temperature for 10 to 20 minutes to allow the heat to be evenly distributed in the food.

## Reheating

Type of food	Weight (g)	Power (W)	Defrosting time (min)
<b>FOOD</b>			
Steaks	300 g	600	3-5
Whole fish	200 g	600	3-5
Mixed vegetable *	500 g	600	3-5
Side dishes *	500 g	600	3-5
Sauces *	500 g	600	2-4
Soups/stews *	5 dl	750	2-4
Pizza	500 g	600	2-4
Chicken medallions	500 g	600	2-4
Open sandwiches	/	600	2-4
Popcorn	90 g	1000	2-4
Melting chocolate	100 g	600	2-4
Butter softening	250 g	180	2-4
Baby bottle	2 dl	360	3-4
Baby food	4 dl	180	2-3
<b>BEVERAGE</b>			
Water	2 dl	1000	1-2
Coffee	2 dl	1000	1-2
Mulled wine	2 dl	1000	1-2
Milk	2 dl	1000	1-2

\* Stir the food several times during reheating.

## Cooking

Type of food	Weight (g)	Power (W)	Cooking time (min)
<b>MEAT</b>			
Chicken thighs **	1000	600	20-30
Chicken wings **	1000	600	15-25
Chicken braised in sauce *	500	1000	15-25
Chicken - whole **	1500	600	45-60
Pork roast **	1000	600	45-60
Pork chops **	500	750	25-35
Steaks **	500	1000	10-20
Meat loaf	700	600	25-35
Meatballs *	1000	1000	10-20
Fish **	200	600	15-20
<b>DESSERTS</b>			
Chocolate soufflé	6	360	12-17
Cheese soufflé	glass baking dish	750	15-20
Fruit purée	glass baking dish	750	12-17
Custard creams	glass baking dish	360	23-28

Type of food	Weight (g)	Water addition	Power (W)	Cooking time (min)
<b>VEGETABLE</b>				
Potatoe	500	1 tablespoons/100 g	1000	13-18
Eggplant / aubergines	500	1 tablespoons/100 g	600	13-18
Courgettes	500	1 tablespoons/100 g	360	10-15
Carrots	500	1 tablespoons/100 g	1000	10-15
Onions	200	1 tablespoons/100 g	1000	5-10
String beans	500	1 tablespoons/100 g	750	10-15
Broccoli	1000	1 tablespoons/100 g	750	10-15
Bell peppers	500	1 tablespoons/100 g	1000	8-13
Cauliflower	1000	1 tablespoons/100 g	750	18-23
Leeks	200	1 tablespoons/100 g	1000	10-15
Brussels sprout	500	1 tablespoons/100 g	1000	10-15

Type of food	Weight (g)	Water addition	Power (W)	Cooking time (min)
Button mushrooms / Champignons	500	1 tablespoons/100 g	1000	10-15
Asparagus	500	1 tablespoons/100 g	750	5-10
Peas	500	1 tablespoons/100 g	750	25-30
Cabbage	500	1 tablespoons/100 g	750	15-20

#### SIDE DISHES

Rice	200	Ratio food to liquid 1:2	750	15-20
Pasta	200	Ratio food to liquid 1:2	750	10-15
Whole grain pasta	200	Ratio food to liquid 1:2	1000	10-15
Oatmeal	500	Ratio food to liquid 1:2	1000	5-10
Brown rice	200	Ratio food to liquid 1:2	750	25-30
Risotto	500	Ratio food to liquid 1:2	750	20-25
Couscous	250	Ratio food to liquid 1:2	1000	3-8
Polenta	250	Ratio food to liquid 1:3	1000	5-10
Millet	250	Ratio food to liquid 1:3	1000	10-15

Type of food	Weight (g)	Power (W)	Cooking time (min)
<b>FROZEN PRODUCTS</b>			
Meat loaf	700	600	35-45
Chicken - whole **	1500	600	55-65
Pork roast **	1000	600	50-60
Chicken medallions **	500	750	10-15
Mixed vegetable *	500	750	10-20
Fish **	200	600	10-15

\* Stir the food several times during reheating.

\*\* Turn halfway through the cooking process.



# MAINTENANCE & CLEANING



Be sure to unplug the appliance from the power supply and wait for the appliance to cool down.

Children should not clean the appliance or perform maintenance tasks without proper supervision.

## Aluminium finish

Clean the aluminium finish with non-abrasive liquid cleaners intended for such surfaces. Apply the cleaner onto a wet cloth and clean the surface. Then, rinse the surface with water. Do not apply the cleaner directly onto the aluminium finish.

Do not use abrasive cleaners or sponges.

Note: The surface should not come into contact with oven cleaning sprays as this may result in visible and permanent damage.

## Stainless steel sheet front side of the housing

(depending on the model)

Clean this surface only with a mild detergent (soapsuds) and a soft sponge that will not scratch the finish. Do not use abrasive cleaners or cleaners containing solvents as they may damage the housing finish.

## Lacquer-coated surfaces and plastic parts

(depending on the model)

Do not clean the knobs and buttons, door handles, stickers, and rating/type plates with abrasive cleaners or abrasive cleaning materials, alcohol-based cleaners, or with alcohol. Immediately remove any stains with a soft non-abrasive cloth and some water, in order to avoid damaging the surface.

You may also use cleaners and cleaning materials intended for such surfaces as instructed by their respective manufacturers.

## Appliance door

The door is attached to the appliance and may not be removed. Also, the door may not be disassembled or otherwise tapered with.



The aluminium-coated surfaces should not come into contact with oven cleaning sprays as this may result in visible and permanent damage.

# CONVENTIONAL OVEN CLEANING

You may use the standard cleaning procedure to clean stubborn dirt in the oven (using cleaners or an oven spray). After such cleaning, rinse the cleaner residues thoroughly.

Clean the oven and the accessories after each use to prevent the dirt from burning into the surface. The easiest way to remove fat is by using warm soapsuds while the oven is still warm.

With stubborn dirt and grime, use conventional oven cleaners. Rinse the oven thoroughly with clean water to remove all cleaner residue.

Never use aggressive cleaners, abrasive cleaners, abrasive sponges, stain and rust removers etc.

Clean the accessories (baking sheets and trays, grids etc.) with hot water and detergent.

The oven, the oven cavity and the baking trays are lined with a special enamel coating for a smooth and resistant surface. This special coating makes cleaning at room temperature easier.

# USING THE AQUA CLEAN FUNCTION TO CLEAN THE OVEN

Pour 0.6 l of water into a glass or shallow baking dish and insert it into the lower guide.



Choose "Extra/Additional Functions" in the main menu and select the Aqua Clean symbol.

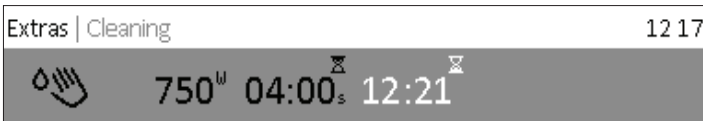

Press the START key.

 After 4 minutes, food residues on the oven enamel walls will have softened and they will be easy to clean with a damp cloth.



**Use the Aqua Clean function when the oven has fully cooled down.**

# REMOVING AND CLEANING THE WIRE GUIDES

Only use conventional cleaners to clean the guides.

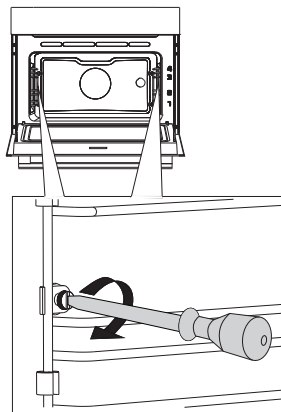

**1** Undo the screw. Use a screwdriver.

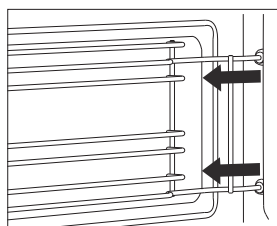

**2** Remove the guides from the holes in the back wall.

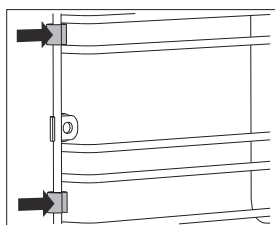

Take care not to lose the spacers fitted on the wire guides. Replace the spacers after cleaning; otherwise, sparks may appear.



After cleaning, re-tighten the screws on the guides with a screwdriver.  
When replacing the wire guides, make sure you mount them on the same side they were installed on prior to removal.

# REPLACING THE BULB

The bulb is a consumable and therefore not covered by warranty. Before changing the bulb, remove the trays, the grid, and the guides.

Use a Phillips (cross) screwdriver.  
(Halogen lamp: G9, 230 V, 25 W)

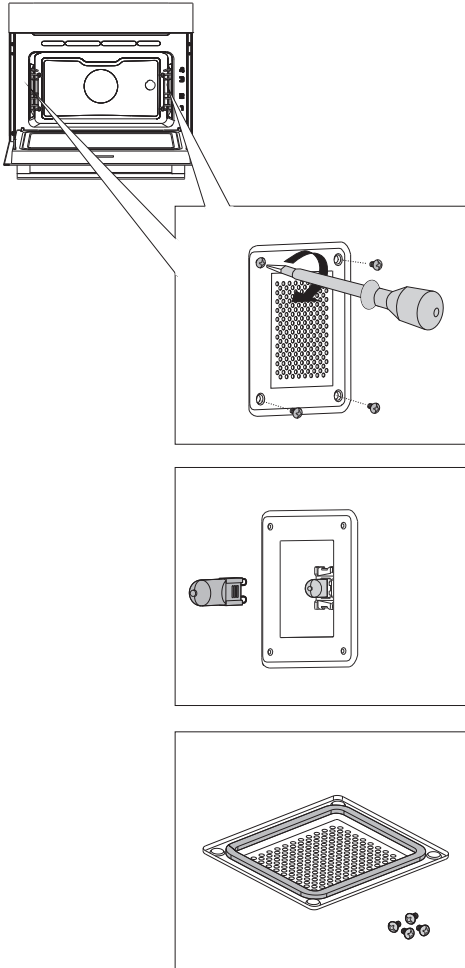

- 1 Undo the four screws on the cover.  
Remove the cover and the glass.

- 2 Remove the halogen light bulb and  
replace it with a new one.



Use protection to avoid burns.



There is a gasket on the cover which should not be removed. Do not allow the gasket to be detached from the cover. The gasket should fit correctly onto the oven cavity wall.



**Firmly re-tighten the screws on the cover using a screwdriver; otherwise, sparks may appear.**

# TROUBLESHOOTING TABLE

Problem/error	Solution
<b>There is no response of the sensors; the display is frozen.</b>	Disconnect the appliance from the power mains for a few minutes (undo the fuse or switch off the main switch); then, reconnect the appliance and switch it on.
<b>The main fuse in your home trips often.</b>	Call a service technician.
<b>The oven lighting does not work.</b>	The process of changing the light bulb is described in the chapter. Cleaning and Maintenance.
<b>The pastry is underdone.</b>	Did you choose the right temperature and heating system? Is the oven door closed?
<b>Error code is displayed: ERRXX ... * XX denotes the number/code of the error.</b>	There is an error in the electronic module operation. Disconnect the appliance from the power mains for a few minutes. Then, reconnect it and set the time of day. If the error is still indicated, call a service technician.
<b>Sparks appear in the oven.</b>	Make sure all covers of the lights are fastened and that all spacers are fitted on the wire guides. Make sure the guides are correctly placed in the appliance.

If the problems persist despite observing the advice above, call an authorized service technician. Repair or any warranty claim resulting from incorrect connection or use of the appliance shall not be covered by the warranty. In this case, the user will cover the cost of repair.



**Before the repair, disconnect the appliance from the power mains (by removing the fuse or by removing the plug from the wall outlet).**

# DISPOSAL

---



Packaging is made of environmentally friendly materials that can be recycled, disposed of, or destroyed without any hazard to the environment. To this end, packaging materials are labelled appropriately.

The symbol on the product or its packaging indicates that the product should not be treated as normal household waste. The product should be taken to an authorized collection center for waste electric and electronic equipment processing.





Correct disposal of the product will help prevent any negative effects on the environment and health of people which could occur in case of incorrect product removal. For detailed information on removal and processing of the product, please contact the relevant municipal body in charge of waste management, your waste disposal service, or the store where you bought the product.

*We reserve the right to any changes and errors in the instructions for use.*



# COOKING TEST

Food tested in compliance with the EN 60350-1 standard.

## Microwave cooking

Dish	Equipment	Guide (from the bottom)	Power (W)	Cooking time (min)	System
Egg custard, 1000 g	Glass container, dimension 25x25 cm, uncovered + glass baking dish	1	360	23-28	
Sponge cake	Round glass container, diameter 22 cm, uncovered + glass baking dish	1	360	22-25	
Meatloaf, 900 g	Glass container, dimensions 25x 12.5 cm, uncovered + glass baking dish	1	600	10	
			Defrost meat (minced meat), 500 g	12-15	
Defrost meat (minced meat), 500 g	Glass baking dish	1	180	8	
			90	15-17	
Defrosting raspberries, 250 g	Glass container, uncovered + glass baking dish	1	180	7-7.30	

## Combined microwave cooking

Dish	Equipment	Guide (from the bottom)	Temperature (°C)	Power (W)	Cooking time (min)	System
Potato gratin	Round glass container, diameter 22 cm, uncovered + glass baking dish	1	190	600	25-30	
Cake	Round glass container, diameter 22 cm, uncovered + glass baking dish	1	180	180	22-25	
Chicken (1,2 kg)*	Glass container, uncovered + glass baking dish	1	210-220	360	45-55	

## Degrees of doneness for meat

TYPE OF MEAT	Core temperature (°C)
<b>BEEF</b>	
Raw	40-45
Rare	55-60
Medium	65-70
Well done	75-80
<b>VEAL</b>	
Well done	75-85
<b>PORK</b>	
Medium	65-70
Well done	75-85
<b>LAMB</b>	
Well done	79
<b>MUTTON</b>	
Raw	45
Rare	55-60
Medium	65-70
Well done	80
<b>GOAT MEAT</b>	
Medium	70
Well done	82
<b>POULTRY</b>	
Well done	82
<b>FISH</b>	
Well done	65-70









---

**gorenje<sup>+</sup>**



489562