

EN

DETAILED INSTRUCTIONS FOR USE OF A COMBINED STEAM OVEN

gorenje

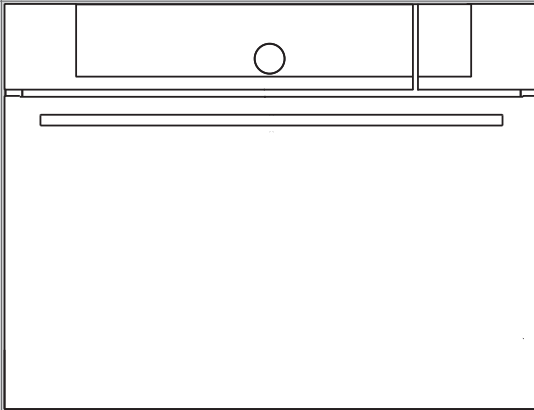

We thank you for your trust and the purchase of our appliance.

This detailed instruction manual is supplied to make the use of this product easier. The instructions should allow you to learn about your new appliance as quickly as possible.

Make sure you have received an undamaged appliance. If you do find transport damage, please contact the seller from which you purchased the appliance, or the regional warehouse from which it was supplied. The telephone number can be found on the invoice or on the delivery note.

Instructions for installation and connection are supplied on a separate sheet.

Instructions for use are also available at our website:

www.gorenje.com / < <http://www.gorenje.com> />



Important information



Tip, note

CONTENTS

4 IMPORTANT SAFETY INSTRUCTIONS 6 Before connecting the appliance: 7 Technical specifications	INTRODUCTION
8 COMBINED STEAM OVEN 12 Control unit	
14 BEFORE USING THE APPLIANCE FOR THE FIRST TIME 14 Steam cooking 15 Testing water hardness 16 Filling the water tank	PREPARING THE APPLIANCE FOR THE FIRST USE
17 SWITCHING ON THE APPLIANCE FOR THE FIRST TIME	
18 STEPS OF THE COOKING PROCESS (1-7) 18 Step 1: CHOOSING THE BASIC COOKING MENUS AND SETTINGS 26 Step 2: TIMER FUNCTIONS - DURATION 27 Step 3: STEP COOKING 30 Step 4: START THE COOKING PROCESS 30 Step 5: END THE COOKING PROCESS AND SWITCHING OFF THE OVEN 32 Step 6: SELECTING ADDITIONAL FUNCTIONS 35 Step 7: CHOOSING THE GENERAL SETTINGS	COOKING STEPS
37 DESCRIPTIONS OF SYSTEMS (COOKING MODES) AND COOKING TABLES	
57 MAINTENANCE & CLEANING 58 Conventional oven cleaning 58 Using the steam clean function to clean the oven 59 Cleaning the steam system 60 Cleaning the filter foam 61 Removing and cleaning the wire guides 62 Removing and inserting the oven door 65 Removing and inserting the oven door glass pane (depending on the model) 66 Replacing the bulb	MAINTENANCE & CLEANING
67 TROUBLESHOOTING TABLE	TROUBLE-SHOOTING
68 DISPOSAL	OTHER

IMPORTANT SAFETY INSTRUCTIONS



CAREFULLY READ THE INSTRUCTIONS AND SAVE THEM FOR FUTURE REFERENCE.

This appliance can be used by children aged from 8 years and above and persons with reduced physical, sensory or mental capabilities or lack of experience and knowledge if they have been given supervision or instruction concerning use of the appliance in a safe way and understand the hazards involved. Children shall not play with the appliance. Cleaning and user maintenance shall not be made by children without supervision.

WARNING: The appliance and its accessible parts become hot during use. Care should be taken to avoid touching heating elements. Children less than 8 years of age shall be kept away unless continuously supervised.

WARNING: Accessible parts may become hot during use. Young children should be kept away.

During use the appliance becomes hot. Care should be taken to avoid touching heating elements inside the oven.

Only use the temperature probe recommended for use in this oven.

WARNING: Ensure that the appliance is switched off before replacing the lamp to avoid the possibility of electric shock.

Do not use harsh abrasive cleaners or sharp metal scrapers to clean the oven door glass/ the glass of hinged lids of the hob

(as appropriate), since they can scratch the surface, which may result in shattering of the glass.

Do not use steam cleaners or high pressure cleaners to clean the appliance as this may result in an electric shock.

Means for disconnection must be incorporated in the fixed wiring in accordance with the wiring rules.

If the supply cord is damaged, it must be replaced by the manufacturer, its service agent or similarly qualified persons in order to avoid a hazard (only for appliances supplied with connection cord) .

The appliance must not be installed behind a decorative door in order to avoid overheating.

The appliance is intended for household use. Do not use it for any other purpose, such as room heating, drying of pets or other animals, paper, fabrics, herbs etc. As this may lead to injury or fire hazard.

The appliance may only be connected to the power mains by an authorized service technician or expert. Tampering with the appliance or nonprofessional repair thereof may result in risk of severe injury or damage to the product.

If the power cords of other appliances located near this appliance are caught in the oven door, they may be damaged, which may in turn result in a short circuit. Therefore, keep the power cords of other appliances at a safe distance.

Do not line the oven walls with aluminium foil and do not place baking trays or other cookware on the oven bottom. Aluminium foil would prevent air circulation in the oven, hinder the cooking process, and ruin the enamel coating.

Oven door become very hot during operation. A third glass is installed for extra protection, reducing the temperature of the outside surface (only with some models).

Oven door become very hot during operation. A third glass is installed for extra protection, reducing the temperature of the outside surface (only with some models).

Oven door hinges may be damaged when under excessive load. Do not place heavy pans on open oven door and do not lean against open oven door when cleaning the oven cavity. Never stand on the open oven door and do not let children to sit on it.

Appliance operation is safe with and without tray guides.

Make sure the vents are never covered or obstructed in any other way.

Safe and correct use of the steam oven

Leave the appliance at room temperature for some time before connecting it to the power mains to allow all components to adapt to room temperature. If the oven is stored at a temperature near or below freezing point, there is a danger for some components, especially the pumps.

The appliance should not operate in an environment with a temperature below 5 °C. Below this temperature, the appliance may not operate correctly. If the appliance is switched on in such conditions, the pump could be damaged.

If the appliance does not work correctly, disconnect it from the power mains.

Do not store items in the oven, which could cause danger when the oven is switched on.

Do not use distilled water that is not suitable for ingestion (e.g. distilled water for batteries, to which acid is added).

After the steam cooking is completed, there is some residual steam in the oven. Open the oven door carefully, as there is danger of scalding with steam. Clean the oven once it has cooled down to room temperature.

After the cooking process, the remaining water in the steam system is pumped back into the water tank. Therefore, the water there could be hot. Be careful when emptying the water tank.

To prevent the build-up of limescale, leave the oven door open after cooking to allow the oven cavity to cool down to room temperature.

It is inadvisable to open the door during the steam cycle, as this will increase power consumption and formation of water condensate.

BEFORE CONNECTING THE APPLIANCE:



Carefully read the instructions for use before connecting the appliance. Repair or any warranty claim resulting from incorrect connection or use of the appliance shall not be covered by the warranty.

TECHNICAL SPECIFICATIONS

(DEPENDING ON THE MODEL)

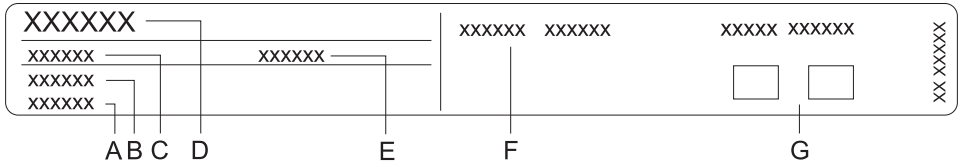

- A Serial number
- B Code/ID
- C Type
- D Brand
- E Model
- F Technical data
- G Compliance symbols

The rating plate indicating the basic information about the appliance is located at the edge of the oven and it is visible when the oven door is opened.

COMBINED STEAM OVEN

(DESCRIPTION OF THE OVEN AND EQUIPMENT - DEPENDING ON THE MODEL)

The figure represents one of the built-in appliance models. Since the appliances for which these instructions were drawn up may have different equipment, some functions or equipment may be described in the manual that may not be present in your appliances.

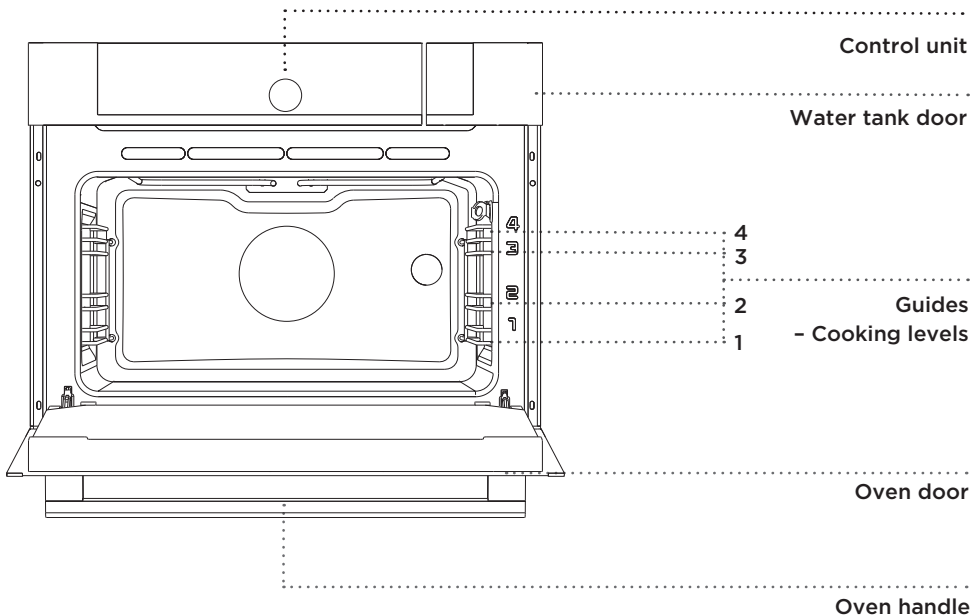

WIRE GUIDES

The wire guides allow preparation of the food on 4 levels (please note that the levels/guides are counted from the bottom up).

Guides 3 and 4 are intended for grilling.

TELESCOPIC PULL-OUT GUIDES

Telescopic pull-out (extendible) guides may be fitted for the second and third level.

Pull-out guides can be partly or fully extendible.

OVEN DOOR SWITCH

The switches deactivate oven heating and the fan when the oven door is opened during the cooking process. When the door is closed, the switches turn the heaters back on.

COOLING FAN

The appliance is fitted with a cooling fan that cools the housing and the appliance control panel.

EXTENDED OPERATION OF THE COOLING FAN

After the oven is switched off, the cooling fan continues to operate for a short while in order to cool the oven. (Extended cooling fan operation depends on the temperature in the center of the oven).

OVEN EQUIPMENT AND ACCESSORIES (depending on the model)

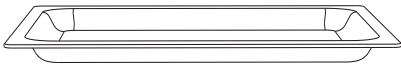

GLASS BAKING DISH is used for cooking with all oven systems. It can also be used as a serving tray.



The **GRID** is used for grilling or as support for a pan, baking tray or baking dish with the food.



There is a safety latch on the grid. Therefore, lift the grid slightly at the front when pulling it out from the oven.

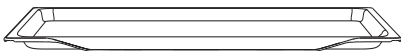

The **SHALLOW BAKING SHEET** is used for baking pastry and cakes.

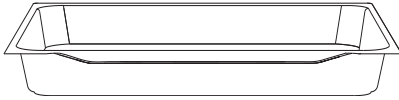

The **DEEP BAKING TRAY** is used for roasting meat and baking moist pastry. It can also be used as a drip tray.

 Never place the deep baking tray in the first guide during the cooking process, except when grilling food or using the roasting spit and you are only using the deep tray as a drip tray.

 **As baking accessories heat up, their form may change. This does not affect their functionality and their original form will be restored when they cool down.**

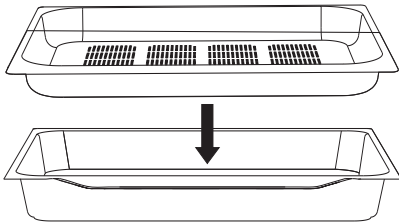

STEAM SET (INOX) is used for cooking vegetables, potatoes, fish or meat. The tray prevents contact between the food and condensate collected in the deep tray.

 Always use the entire steam set (only for steam cooking) on the 2nd guide.

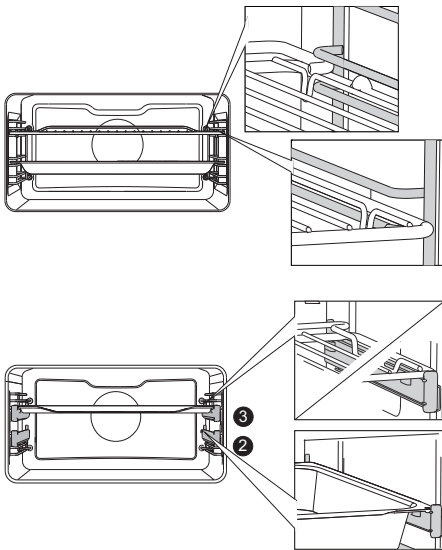

In case of wire guides, the tray should always be inserted into the groove between the two wire profiles.

With telescopic extendible guides, first pull out the guides of one level and place the grid or the baking tray onto them. Then, push them in with your hand as far as they will go.

 Close the oven door when the telescopic guides are retracted all the way into the oven.

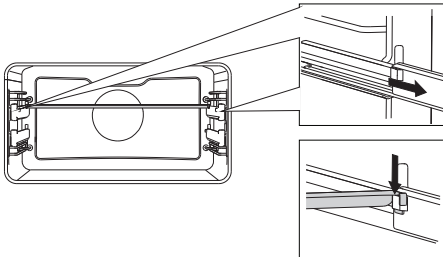

SYNCHRONIZATION BAR

The bar can be installed or removed on the fully retractable telescopic guides. First, completely pull out both guides of the desired level. Insert the bar into the two slots on the guides and push the guides in with your hand until they stop.

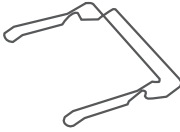

BAKING PAN SUPPORT allows easy removal of baking pans from the oven while they are still hot.

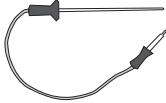

PROBE for roasting larger chunks of meat.

DESCALING AGENT for cleaning the steam system.

TEST PAPER STRIP for testing water hardness.

MECHANICAL DOOR LOCK prevents the opening of oven door until the lock is released.
To open it, gently push your thumb to the right while pulling the door outwards.



The appliance and some of the accessible parts tend to heat up during cooking. Use oven mitts.

CONTROL UNIT

(Depending on the model)

PROFESSIONAL MODE

QUICK ACCESS
TO STEAM
PROGRAMS

AUTOMATIC

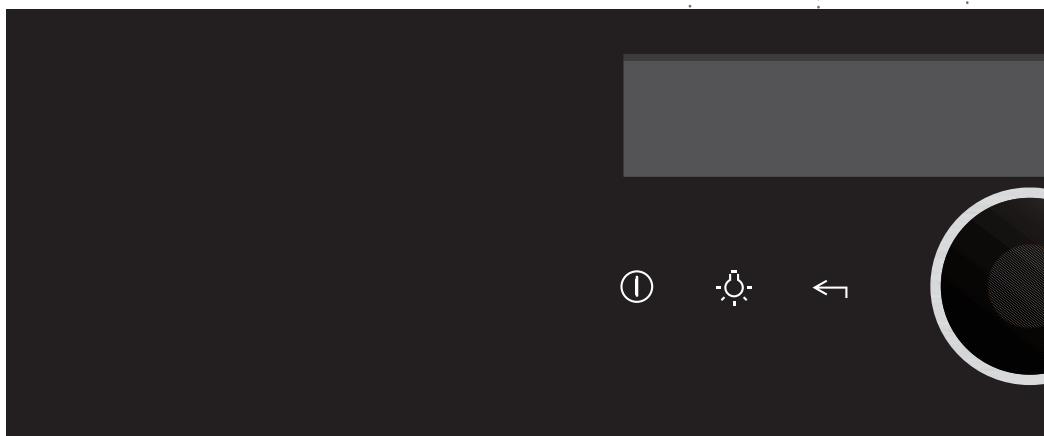

1 ON/OFF KEY

2 OVEN
LIGHTING ON/
OFF KEY

3 BACK KEY

4 Selection and
CONFIRMATION
KNOB

Touch briefly to
return to previous
menu.

Select the setting by
rotating the knob.

Touch and hold to
return to main menu.

Confirm your
selection by pressing
the knob.

MY RECIPES

EXTRA
FUNCTIONS

GENERAL
SETTINGS



5 MINUTE
MINDER/
ALARM

6 CHILD LOCK
KEY
Locking the control
unit

7 START/STOP
KEY
Long touch: START

8 DISPLAY -
displays all
settings

Long touch during
operation: STOP

NOTE:

The keys will respond better if you touch them with a larger area of your fingertip. Each time you press a key, this will be acknowledged by a short acoustic signal.

BEFORE USING THE APPLIANCE FOR THE FIRST TIME

After receiving the appliance remove all parts, including any transport equipment (cardboard and polystyrene inserts), from the oven.

Clean all accessories and utensils with warm water and regular detergent. Do not use any abrasive cleaners.

Before using the oven for the first time, heat it with the upper and lower heater system at 200 °C for approximately one hour. The characteristic "new appliance" scent will be released; make sure the room is well ventilated.

STEAM COOKING

Healthy and natural, steam cooking preserves the full flavour of foods. This cooking method releases no odours. There is no need to add salt to the water or to add herbs and spices.

Following are the advantages of steam cooking:

Cooking (braising, roasting) starts before the temperature inside the oven reaches 100 °C. Slow cooking (braising, roasting) is also possible at lower temperatures.

It is healthy: vitamins and minerals are well preserved because only a small share of them is dissolved in the condensation water that touches the food.

There is no need to add any fat during the cooking process. The steam maintains the taste of food. It does not add odours, nor the taste of the grill or the pan. Furthermore, it takes nothing away because the food is not diluted in the water. Steam does not spread the flavour or smell; therefore, meat or fish can be cooked together with vegetables. Steam is also suitable for blanching, defrosting and reheating or keeping the food warm.

TESTING WATER HARDNESS

Water hardness test should be carried out before first use.

A warning will appear on the display: **"Use the test paper to measure water hardness."**



	4 green stripes	Soft
	1 red stripe	Slightly hard
	2 red stripes	Medium hard
	3 red stripes	Hard
	4 red stripes	Very hard

Soak the test paper strip (supplied with the appliance) in water for one (1) second.

Wait one minute and observe the number of stripes on the paper. Enter the information on the number of stripes into the appliance. Rotate the KNOB and confirm the selection with the CHECK MARK.

The highest water hardness is set as a factory default.

CHANGING THE WATER HARDNESS SETTING

Water hardness can also be set in the menu CHOOSING THE GENERAL SETTINGS.



If the correct water hardness level is not set, this could affect appliance operation and its useful life.

FILLING THE WATER TANK

The tank allows for independent water supply to the steamer. The tank volume amounts to approx. 1.3 litres (maximum water level – see marking). This amount of water allows approximately 3 hours of cooking time with max. steam cycle (hot air with steam on “high” system).

 Clean the water tank before the first use.



Always fill the water tank with clean and cool water from the pipeline, bottled water without additives, or distilled water suitable for use in cooking. Water that is poured into the water tank should be at a temperature of 20 °C +/- 10 °C.

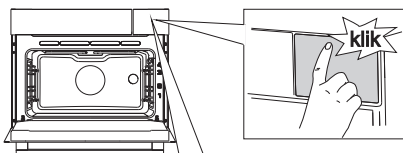

1 Press on the spot with the sticker to open the tank door.

 The sticker can be later removed.

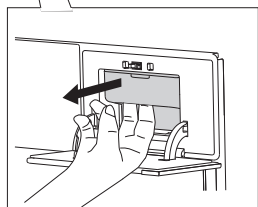

2 Remove the water tank from the housing by grabbing the notch.

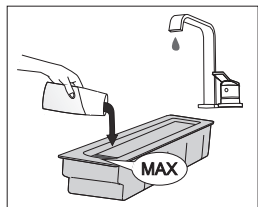

3 Open the lid. Wash the tank with water. Re-assemble the tank. Before use, add fresh water up to the MAX marking on the tank.

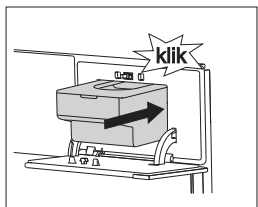

4 Push the water tank back into the housing to the final position (until the short click). Then, press the tank door to close it.

 After the cooking process, the remaining water in the steam system is pumped back into the water tank. The lid and the water tank can be washed with standard non-abrasive liquid cleaners or in a dishwasher.

SWITCHING ON THE APPLIANCE FOR THE FIRST TIME

SETTING THE CLOCK

After connecting your appliance or after an extended power outage, 12:00 will flash on the display.

Set the time of day.



Confirm each setting by pressing the KNOB.



Press the KNOB to set the time.



Turn the KNOB and first set the TICK.



The oven will also work if the clock is not set. However, timer functions are not available in this case (see chapter **SETTING THE TIMER FUNCTIONS**). After a few minutes of idling, the appliance will switch to standby mode.

CHANGING THE CLOCK SETTING

Clock settings may be changed when no timer function is activated (see chapter **CHOOSING THE GENERAL SETTINGS**).

SELECTING THE LANGUAGE

If you are not happy with the language in which the messages on the display are presented, select another one. English is the preset language.

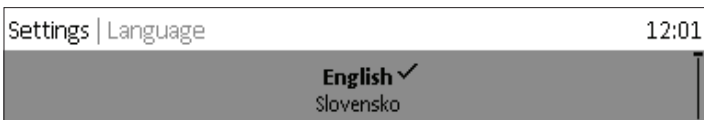

Rotate the KNOB and select your language from the list. CONFIRM the selection. The main menu will appear.

STEPS OF THE COOKING PROCESS (1-7)

STEP 1: CHOOSING THE BASIC COOKING MENUS AND SETTINGS

The process of preparing food in your oven can be controlled in several ways:

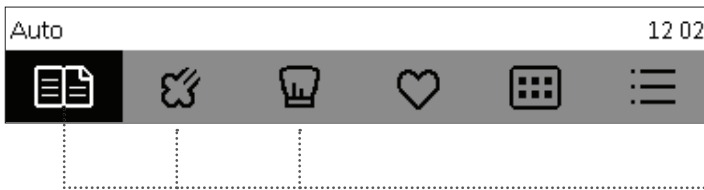

Rotate the KNOB and select the symbol. The symbol will turn white. The NAME of the selected menu will appear at the top.



Confirm each setting by pressing the KNOB.



Automatic mode

In this mode, first select the type of food. This is followed by automatic setting of the quantity, level of doneness, and cooking end time.

The program offers a large choice of preset recipes reviewed by professional chefs and nutrition experts.



Quick access to steam programs

This is a natural cooking mode that preserves the full flavour of the food.



Professional mode

Use this mode when you wish to prepare any type and amount of food. All settings are selected by the user.

A) COOKING BY SELECTING THE TYPE OF FOOD (Auto mode)

 Confirm each setting by pressing the KNOB.



Rotate the KNOB and select the Auto mode. Confirm the setting by pressing on the KNOB.



Select the type of food and the dish. Confirm the selection.



Preset values will appear. Rotate the KNOB and confirm by pressing the KNOB to change these settings.

- 1 Amount
- 2 Doneness
- 3 Delayed start
- 4 Cooking duration
- 5 Cooking system and recommended level

 When in the **Auto mode**, choose the duration or system symbol to open the Professional mode (see section on COOKING BY SELECTING THE OPERATING MODE).

Touch the START/STOP key to start oven operation.
All selected settings are indicated on the display.

PREHEAT

Some dishes in the Auto mode also include the preheat function 

When you select the food, the following note will appear: **"Selected program includes preheating." Preheating started.** Do not insert the food yet. The symbol °C will flash on the display.

When the selected temperature is reached, the preheating process stops and an acoustic signal is emitted.

The following note will appear on the display: **"Preheating complete"**. Please insert the food. Open the door or confirm by pressing the KNOB. The program then resumes the cooking process with selected settings.



When the preheat function is set, delayed start function cannot be used.

B) STEAM COOKING (quick access to steam programs)

 Confirm each setting by pressing the KNOB.



Rotate the KNOB and select Steam. Confirm the setting by pressing on the KNOB.

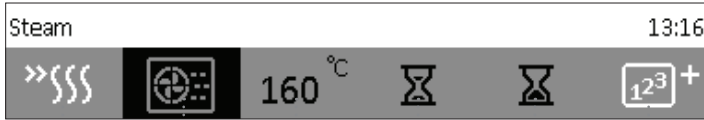





Select the settings by rotating the KNOB and pressing it to confirm.

1 2 3 4 5 6

- 1 Preheating
- 2 Hot air with steam
- 3 Oven temperature
- 4 Cooking duration
- 5 Delayed start
- 6 Step mode (see section STEP COOKING)

Use the preheat function  if you wish to heat the oven to the desired temperature as quickly as possible.

Fill the water tank with fresh water up to the MAX marking. Use the STEAM SET to cook vegetables, fish, meat, and potatoes – when not cooking in a sauce. Place the steam set into the 2nd guide.

SYSTEM	DESCRIPTION	PRESET TEMPERATURE (°C)	MIN - MAX TEMPERATURE (°C)
	<p>HOT AIR WITH STEAM Microwaves are used for cooking and defrosting. They allow quick and efficient cooking without changing the colour or shape of the food. Three options are available:</p>	180	
	HIGH: cooking escalopes, steaks, and smaller chunks of meat		30 - 230
	MEDIUM: reheating cool/frozen meals, cooking fish fillets and vegetables au gratin		30 - 230
	LOW: cooking large chunks of meat (roast, whole chicken), baking risen dough (bread and rolls), cooking lasagne etc.		30 - 230
	STEAM Use this for all types of meat, stews, vegetables, pies, cakes, bread, and dishes au gratin (i.e. food that require longer cooking time).	100	40-100

Touch the START key to start oven operation.

The symbol °C will flash on the display until the selected temperature is reached.

C) COOKING BY SELECTING THE OPERATING MODE (Professional mode)

 Confirm each setting by pressing the KNOB.



Rotate the KNOB and select **Professional (Pro) mode**. Confirm the selection.

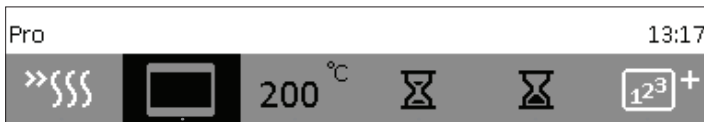

Select the settings by rotating the KNOB and pressing it to confirm.

1 2 3 4 5 6

- 1 Preheating
- 2 System
- 3 Oven temperature
- 4 Cooking duration
- 5 Delayed start
- 6 Step cooking









PREHEAT



Use the preheat function  if you wish to heat the oven to the desired temperature as quickly as possible. When this symbol is selected, the preheat function will be switched on and a warning will appear. **"Preheating started."** Do not insert the food yet. The symbol °C will flash on the display.

When the selected temperature is reached, the preheating process stops and an acoustic signal is emitted. The following note will appear on the display: **"Preheating complete"**. Please insert the food. Open the door or confirm by pressing the KNOB. The program then resumes the cooking process with selected settings.

 When the preheat function is set, delayed start function cannot be used.

COOKING SYSTEMS (depending on the model)

SYSTEM	DESCRIPTION	PRESET TEMPERATURE (°C)	MIN - MAX TEMPERATURE (°C)
COOKING SYSTEMS			
	UPPER AND BOTTOM HEATER The heaters in the bottom and in the ceiling of the oven cavity will radiate heat evenly into the oven interior. Pastry or meat can only be baked/roasted at a single height level.	200	30 - 230
	UPPER HEATER Only the heater on the oven cavity ceiling will radiate heat. Use this heater to brown the upper side of the dish.	150	30 - 230
	BOTTOM HEATER Only the heater on the bottom of the oven cavity will radiate heat. Use this heater to brown the lower side of the dish.	160	30 - 230
	GRILL Only grill heater, a part of the large grill set, will operate. Use this heater to grill a few open sandwiches or beer sausages, or for toasting bread.	230	30 - 230
	LARGE GRILL The upper heater and the grill heater will operate. The heat is radiated directly by the grill heater installed in the oven ceiling. To boost the heating effect, the upper heater is activated as well. This system is used for grilling a smaller amount of open sandwiches or beer sausages, and for toasting bread.	230	30 - 230
	GRILL WITH FAN Grill heater and the fan will operate. This combination is used to grill meat and to roast larger chunks of meat or poultry at a single height level. It is also appropriate for dishes au gratin and for browning to a crispy crust.	170	30 - 230
	HOT AIR AND BOTTOM HEATER Bottom heater, round heater, and the fan will operate. This is used to bake pizza, moist pastry, fruitcakes, leavened dough and shortcrust on several levels simultaneously.	200	30 - 230
	3D HOT AIR Round heater and the fan will operate. The fan installed in the back wall of the oven cavity makes sure the hot air constantly circulates around the roast or pastry. This mode is used for roasting meat and baking pastry at several levels simultaneously.	180	30 - 230
	ECO COOKING ¹⁾ In this mode, power consumption during the cooking process is optimized. This mode is used for roasting meat and baking pastry.	180	

SYSTEM	DESCRIPTION	PRESET TEMPERATURE (°C)	MIN - MAX TEMPERATURE (°C)
COOKING SYSTEMS			
	BOTTOM HEATER AND FAN This is used for baking leavened but low-rising pastry and for preserving fruit and vegetables.	180	30 - 230
	AUTOMATIC COOKING OF MEAT - AUTO ROAST MODE In the Auto Roast mode/system, the upper heater will operate in combination with the grill heater and the round heater. It is used for roasting all types of meat.	180	30 - 230

¹⁾ It is used for determining the energy efficiency class pursuant to the EN 60350-1 standard.

Touch the START key to start oven operation. All selected settings are indicated on the display.

 The symbol °C will flash on the display until the selected temperature is reached. A short beep will be heard. Cooking/baking systems cannot be changed during operation.

STEP 2: TIMER FUNCTIONS - DURATION

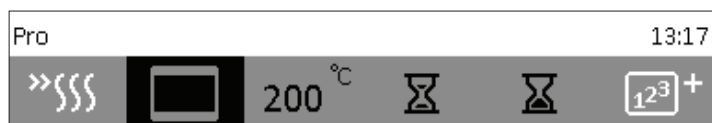

The "Duration" setting can be selected in the basic Professional (Pro) Mode and in the Steam Cooking Mode.

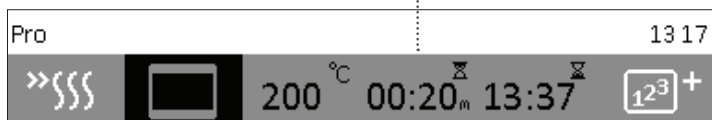

Cooking duration

Delayed start



Setting the cooking time

In this mode, you can define the duration of oven operation (cooking time). Set the desired cooking time and confirm the setting (Maximum operating time is 10 hours.). Cooking end time is adjusted accordingly. Press START to start the cooking process. All selected settings are indicated on the display. All timer functions can be cancelled by setting the time to "0".



Setting the delayed start

In this mode, you may specify the duration of the cooking process (cooking time) and the time when you wish the cooking process to stop (end time) (Delayed start function allows delaying the start by up to 24 hours.). Make sure the clock is accurately set to current time.

Example:

Current time: 12:00

Cooking duration: 2 hours

End of cooking: 6 pm

First, set the cooking time (COOKING DURATION), i.e. 2 hours. The sum of the current time and cooking time is automatically displayed (2 pm).

How, set the COOKING END TIME and set the time (6 PM). Press START to start the cooking process. The timer will wait for the start of the cooking process. The following note will appear on the display:

"Cooking start is delayed. Cooking will start at 16:00."



After the set time expires, the oven will automatically stop operating (end of cooking). An acoustic signal will be heard which you may turn off by pressing the ALARM key. After one minute, the acoustic signal will be switched off automatically.

After a few minutes of idling, the appliance will switch to standby mode. The time of day will appear.

STEP 3: STEP COOKING

This mode allows you to combine three different cooking modes successively in a single cooking process.

Choose different settings to cook your food just the way you want it.

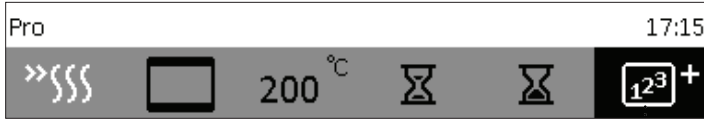

Select the "Step cook" setting in the basic Professional (Pro) mode and Steam Cooking mode. Confirm the setting by pressing on the KNOB.



Select: step 1, step 2, step 3
Confirm the settings by pressing on the KNOB.



The first step will already have been selected if you have already set the timer functions.

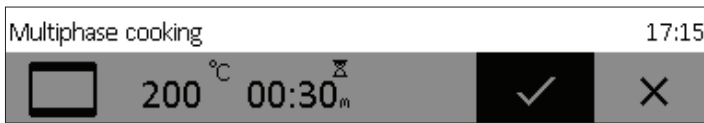

Set the cooking system, temperature, and time. Confirm the setting with the CHECK MARK by pressing on the KNOB.

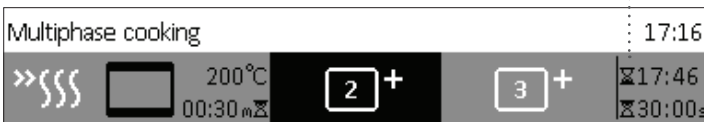

Total cooking time - end.

Current step

Temperature and duration of the selected step

Touch the START symbol to turn on the oven. The oven starts operating immediately, with the settings defined in Step 1. (A strip at the bottom of the display indicates the cooking step currently in progress.) After the set cooking time elapses, Step 2 and then Step 3 are activated, if specified.



 If you wish to delete a step during operation, turn the KNOB, choose the step and cancel it by confirming the X mark. This can only be done with steps that have not started yet.

STEAM INJECTION

Steam injection is recommended when cooking

- **meat** (towards the end of the cooking process): the meat will be juicier and softer, and steam injection does away with the need for basting. Meat: beef, veal, pork, venison, poultry, lamb, fish, sausages;
- **bread, bread rolls**: use steam during the first 5-10 minutes of baking. The crust will be crunchy and nicely browned.
- **vegetable and fruit soufflés**, lasagne, starchy dishes, puddings:
- **vegetables**, especially potatoes, cauliflower, broccoli, carrots, zucchini, eggplant.

Steam injection can be activated in the basic Professional mode by selecting STEP COOKING (see chapter 9).



Total cooking time in the Step Cooking mode may not be shorter than 5 minutes.

Touch the START key to start oven operation.



Select the STEAM (injection) symbol. Confirm your choice with the KNOB.



Rotate the KNOB and select the symbol. Confirm your choice with the KNOB.



Total cooking time in the Step Cooking mode may not be shorter than 5 minutes...



DIRECT STEAM INJECTION

Press the symbol for steam injection. The symbol flashes until the process is complete. Direct steam injection can be repeated in three steps; then, the steam symbol disappears.



STEAM INJECTION BY STEPS

Three injections may be selected by steps. There should be at least a three-minute time gap between successive steam injections. First, steam is injected as a part of Step 1 and the symbol flashes. When the set amount of time expires, the program proceeds with Step 2, followed by Step 3. When all three steps have been carried out, the symbols are switched off.

STEP 4: START THE COOKING PROCESS

The START/STOP key will flash before the start of the cooking process.

Start the cooking process by briefly touching the START key.
Rotate the KNOB to change the current settings during cooking.



STEP 5: END THE COOKING PROCESS AND SWITCHING OFF THE OVEN

For a pause in the cooking process, press the START/STOP key and hold it for a while.

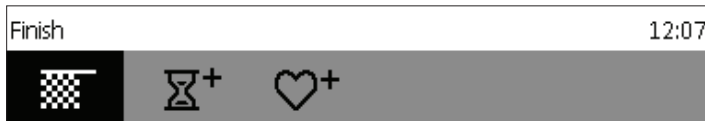

When the cooking process is complete, turn the KNOB to display the End menu with a display of symbols.



End!

Select the icon and complete the cooking process. Main menu will appear on the display.



Extend the cooking time

Cooking time can be extended by selecting the icon. New cooking end time can be selected (see chapter Timer Functions).



Add to my recipes

This mode allows you to save the selected settings into the oven memory and use them again at a later time.



After the end of the cooking process (with the steam system), clean and dry the oven. Empty the water tank, clean it, and dry it.

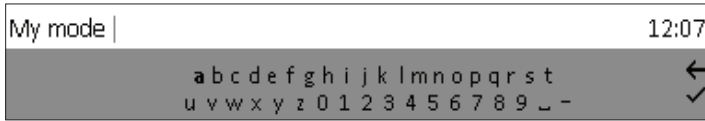

SAVING USER-DEFINED PROGRAMS (MY RECIPES)

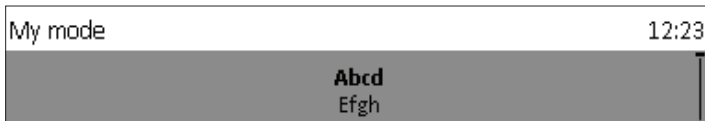

Choose the symbol  and enter the name by rotating the KNOB and confirming the KNOB and confirming respective letters. If necessary, delete a character using the arrow; use the check mark or touch the START/STOP key to confirm the name. Select the type of food.



Select the type of food. Press the KNOB to save your settings.

 Your favourite recipes that you have previously stored in the memory can be retrieved and used at any time. Choose the process and the settings in the main menu by selecting the  symbol.

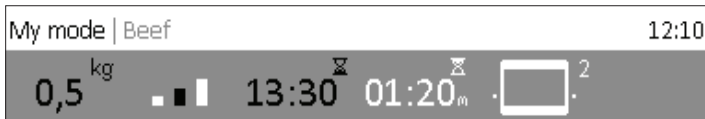

Preset values will appear which you can still change.

Confirm and touch the START key to start the oven operation.

 Up to 10 recipes can be stored in the memory.

DELETING A RECIPE

Select the recipe to be deleted. Press and hold the KNOB to delete the recipe; an acoustic signal will be sounded.

STEP 6: SELECTING ADDITIONAL FUNCTIONS



Choose **Extra** in the main menu to display the extra/additional function menu.



Some functions are not available with some systems; an acoustic signal will indicate such cases.



Steam clean

Use it to remove stains. Pour water into the deep baking tray and place it in the lower guide. After 13 minutes, food residues on the enamel surfaces will have softened and they will be easy to wipe off with a damp cloth.

Use this function when the oven has fully cooled down! (See chapter Cleaning and Maintenance.)



Defrosting

In this mode, the air will circulate without any heaters operating. Only the fan will be activated. Use this function to slowly defrost frozen food (cakes, pastry, bread, rolls, and deep-frozen fruit). By selecting the relevant symbol you may specify the type of food, weight, or defrosting start and end time.

Halfway through the defrost time, the pieces should be turned over, stirred and separated if they were frozen together.



Quick preheat

Use the preheat function if you wish to heat the oven to the desired temperature as quickly as possible. This mode is not appropriate for cooking. When the oven heats up to the selected temperature, the preheat process is completed and the oven is ready for cooking with the selected cooking mode.



Plate heating

Use this function to reheat your dinnerware (plates, cups) before serving food in it to keep the food warm longer. Select the symbol to set the temperature, and reheating start and end time.



Regenerate

This mode is used for reheating cooked food. Owing to the use of steam, there is no loss of quality. Taste and texture are preserved as though the dish was freshly-cooked. A variety dishes can be regenerated simultaneously.

- With this function, the user can set the regeneration process start and end time.



When the cooking proces is complete, turn the KNOB to display the End menu with a display of symbols.



CHILD LOCK

Activate it by touching the LOCK key (key symbol). The following message will appear on the display: **"Child lock activated."** Touch the key again to deactivate the child lock.



If the child lock is activated with no timer function engaged (only clock is displayed), then the oven will not operate. If the child lock is activated after a timer function has been set, then the oven will operate normally; however, it will not be possible to change the settings.

When the child lock is activated, systems (cooking modes) or additional functions cannot be changed. Only the cooking/baking/roasting process can be stopped or switched off.

Child lock remains active after the oven is switched off. To select a new system, the child lock must first be deactivated.



OVEN LIGHTING

Oven lighting is switched on automatically when the door is opened or when the oven is switched on.

After the end of the cooking process or when the door is closed, the light will remain on for another minute.

The light inside the oven can be switched on or off by pressing the LIGHT key.



SETTING THE MINUTE MINDER

The minute minder can be used independently of the oven operation. Activate it by pressing the key. The longest possible setting is 10 hours. When the time expires, an acoustic signal will be heard which you may turn off by touching any key. After one minute, the acoustic signal will be switched off automatically.

STEP 7: CHOOSING THE GENERAL SETTINGS



Choose **Settings** in the main menu to display the menu for various settings.



Rotate the KNOB to navigate the menu. Confirm each setting by pressing the KNOB.

Language

Select the language for the text on the display.

Time

Set the time of day after the appliance is connected to the power mains for the first time or after being disconnected from the power mains for a longer period of time (more than one week). Set the CLOCK - time. Set the display mode in the "Time Design" field: digital or analogue.

Sound

Loudness of the acoustic signal can be set when no timer function is activated (only the time of day is displayed). In this menu, you can set the following: **loudness**.



Display

In this menu, you can set the following:

Lighting

Night mode - specify the time until which you wish the display to be dimmed.



Setting during the cooking process

In this menu, you can set the following:

Oven lighting during operation - oven lighting is switched off when oven door is opened during operation.

Other settings

Switch off oven lighting

Reset to factory defaults

Water hardness

Descaling



After a power outage or after switching off the appliance, all extra user settings are restored.

DESCRIPTIONS OF SYSTEMS (COOKING MODES) AND COOKING TABLES

If your desired food cannot be found in the cooking table, find information for similar food. The information displayed applies to cooking in a single level.

An interval of suggested temperature is indicated. Start with a lower temperature setting and increase it if you find the food is not browned sufficiently.

Cooking times are rough estimates and may vary subject to some conditions.

Only preheat the oven if required by the recipe of in the tables in this instruction manual. Heating an empty oven consumes a lot of energy. Hence, baking several types of pastry or several pizzas successively will save a lot of energy as the oven will already have been preheated.

Use dark, black silicon-layered or enamel-coated baking sheets and trays as they conduct the heat very well.

When using parchment paper, make sure it is resistant to high temperatures.

When cooking larger chunks of meat or pastry, a lot of steam will be generated inside the oven, which in turn may condense on the oven door. This is a normal phenomenon which will not affect the operation of the appliance. After the cooking process, wipe the door and the door glass dry.

Switch off the oven approximately 10 minutes before the end of the cooking process to save energy by making use of the accumulated heat.

Do not cool the food in a closed oven to prevent condensation (dew).



The asterisk (*) in the table means the oven should be preheated with the selected system.

COOKING SYSTEMS

UPPER AND BOTTOM HEATER

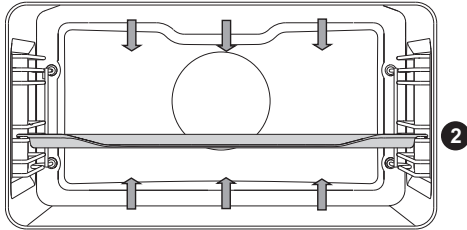

The heaters in the bottom and in the ceiling of the oven cavity will radiate heat evenly into the oven interior.

Roasting meat:

Use enamel coated, tempered glass, clay, or cast iron pan or tray. Stainless steel trays are not suitable as they strongly reflect the heat.

Use enamel coated, tempered glass, clay, or cast iron pan or tray. Stainless steel trays are not suitable as they strongly reflect the heat.

Type of food	Weight (g)	Guide (from the bottom)	Temperature (°C)	Cooking time (min)
MEAT				
Pork roast	1500	1	180-200	90-120
Pork shoulder	1500	1	180-200	110-140
Pork roulade	1500	2	180-200	90-110
Roast beef	1500	1	170-190	120-150
Veal roulade	1500	2	180-200	80-100
Lamb sirloin	1500	1	180-200	60-80
Rabbit loin	1000	2	180-200	50-70
Deer shank	1500	1	180-200	90-120
Meat rolls	/	2	180-200	15-30
FISH				
Braised fish	200 g/piece	2	190-210	40-50

Baking pastry

Only use one level and dark baking sheets or trays. In light-coloured baking sheets or trays, the browning of the pastry will be poorer, as such equipment will reflect the heat. Always place the baking trays on the grid. If you are using the supplied baking sheet, remove the grid. Cooking time will be shorter if the oven is preheated.

Type of food	Guide (from the bottom)	Temperature (°C)	Cooking time (min)
PASTRY			
White bread, 1 kg *	2	220	10-15
		180-190	30-40
Buckwheat bread, 1 kg *	2	180-190	50-60
Whole grain bread, 1 kg *	2	180-190	50-60
Rye bread, 1 kg *	2	180-190	50-60
Spelt bread, 1 kg *	2	180-190	50-60
Sweet soufflé	2	170-190	40-50
Bread rolls *	2	190-210	20-30
Walnut cake	1	170-180	50-60
Sponge cake *	1	160-170	30-40
Macarons (meringue pastry)	2	130-150	15-25
Vegetable rolls	2	190-200	25-35
Fruit rolls	2	190-200	25-35
Small pastries made with yeast dough	2	200-210	20-30
Cabbage pirozhki *	2	190-200	25-35
Fruitcake	1	130-150	80-100
Meringue cookies	2	80-90	110-130
Jelly-filled rolls (Buchtel)	2	170-180	30-40

Tip	Use
Is the cake done?	<ul style="list-style-type: none"> • Pierce the cake at the top with a wooden toothpick or skewer. If there are no traces on the pick or the skewer when pulled out, the cake is done.
Did the cake collapse?	<ul style="list-style-type: none"> • Check the recipe. • Next time, use less liquid. • Note the mixing time when using small mixers, blenders etc.
The cake is too light at the bottom?	<ul style="list-style-type: none"> • Use a dark-coloured baking sheet or tray. • Place the baking sheet one guide lower and switch on the lower heater towards the end of the cooking progress.
Cake with moist stuffing is underdone?	<ul style="list-style-type: none"> • Increase temperature and extend baking time.



Do not insert the deep baking tray into the first guide.

LARGE GRILL, GRILL

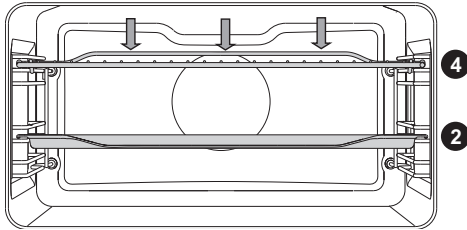

When grilling food with the large grill, the upper heater and the grill heater fitted on the ceiling of the oven cavity will operate.

When grilling with normal (not large) grill, only grill heater, a part of the large grill set, will operate.

Preheat the infrared (grill) heater for five minutes.

Supervise the cooking process at all times. The meat may burn quickly due to high temperature.

Roasting with the grill heater is suitable for crispy and low-fat cooking of bratwurst, cuts of meat and fish (steaks, escalopes, salmon steaks or fillets etc.) or toasted bread.

When grilling directly on the grid, smear it with oil to prevent the meat from sticking onto it and insert it into the 4th guide. Insert the drip tray in to the 1st or 2nd guide. When grilling in a baking tray, make sure there is enough liquid in the tray to prevent burning. Turn the meat during cooking.

After grilling, clean the oven, the accessories, and the utensils.

Grilling table - small grill

Type of food	Weight (g)	Guide (from the bottom)	Temperature (°C)	Cooking time (min)
MEAT				
Beefsteak, rare	180 g/piece	3	230	20-25
Pork neck fillet	150 g/piece	3	230	25-30
Cutlets/chops	280 g/piece	3	230	30-35
Grill sausages	70 g/piece	3	230	20-25
TOASTED BREAD				
Toast	/	3	230	5-10
Open sandwiches	/	3	230	5-10

Grilling table - large grill

Type of food	Weight (g)	Guide (from the bottom)	Temperature (°C)	Cooking time (min)
MEAT				
Beefsteak, rare	180 g/piece	3	230	10-15
Beefsteak, well done	180 g/piece	3	230	15-20
Pork neck fillet	150 g/piece	3	230	15-20
Cutlets/chops	280 g/piece	3	230	20-25
Veal escalope	140 g/piece	3	230	15-20
Grill sausages	70 g/piece	3	230	10-20
Spam (Leberkäse)	150 g/piece	3	230	15-20
FISH				
Salmon steaks/fillets	200 g/piece	3	230	15-20
TOASTED BREAD				
6 slices of bread	/	3	230	1-4
Open sandwiches	/	3	230	2-5

Always keep the oven door closed when using the grill (infrared) heater.

Grill heater, grid, and other oven accessories get very hot during grilling. Therefore, use oven mitts and meat tongs.



Always keep the oven door closed when using the grill (infrared) heater.

Grill heater, grid, and other oven accessories get very hot during grilling. Therefore, use oven mitts and meat tongs.

GRILL WITH FAN

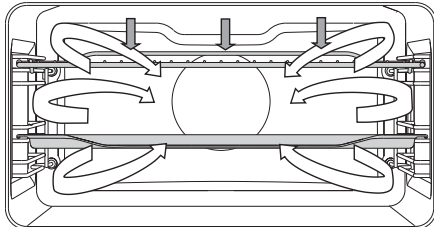

In this operating mode, the grill heater and the fan operate simultaneously. Suitable for grilling meat, fish, and vegetables.

4

2

(See descriptions and tips for GRILL.)

Type of food	Weight (g)	Guide (from the bottom)	Temperature (°C)	Cooking time (min)
MEAT				
Duck	2000	1	180-200	90-110
Pork roast	1500	1	170-190	90-120
Pork shoulder	1500	1	160-180	100-130
Half of chicken	700	1	190-210	50-60
Chicken	1500	1	200-220	60-80
Meat loaf	1500	1	160-180	70-90
FISH				
Trout	200 g/piece	2	200-220	20-30

HOT AIR AND BOTTOM HEATER

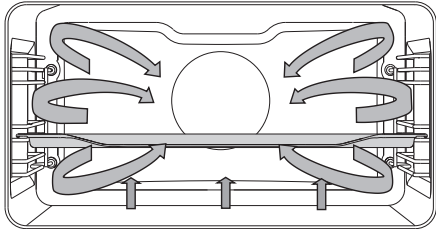

The bottom heater, the round heater, and the hot air fan will operate. Suitable for baking pizzas, apple pies, and fruitcakes.

2 (See descriptions and tips for UPPER and BOTTOM HEATER.)

Type of food	Guide (from the bottom)	Temperature (°C)	Cooking time (min)
Cheesecake, short crust	2	160-170	60-70
Pizza *	2	220-230	10-15
Quiche Lorraine, shortcrust	1	200-210	50-60
Apple strudel, phyllo dough	2	180-190	50-60

Roasting with a meat probe

In this mode, set the desired temperature of the food core. The oven operates until the food core reaches the set temperature. Temperature core is measured by the temperature probe.



Meat probe cannot be used with microwave systems.

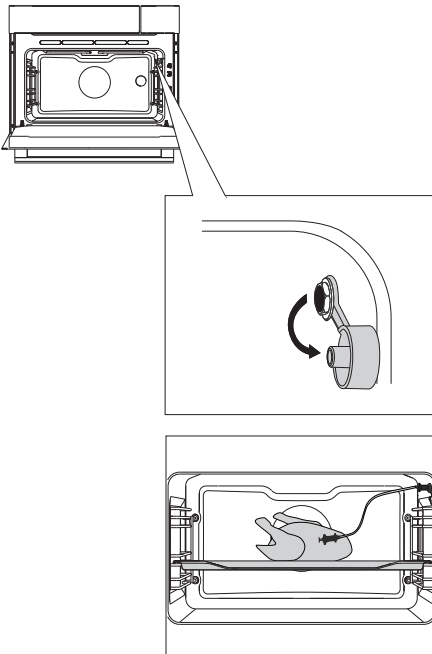

1 Remove the cap (the socket is in the front upper corner of the oven right wall).

2 Connect the meat probe plug to the socket and stick the probe into the food. (If any timer settings were activated, they will be cancelled.)

3 Choose the system (lower heater and fan).

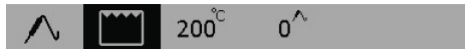

Preset temperature and probe temperature will be displayed. Touch the START key.

 During cooking, the rising temperature of the core will be displayed (the desired core temperature may be adjusted during the cooking process).

When the set core temperature is reached, the cooking process will stop. An acoustic signal will be heard which you may turn off by touching any key. After one minute, the acoustic signal will be switched off automatically. Clock will appear on the display.

After cooking, replace the cap.

Degrees of doneness for meat

TYPE OF MEAT	Core temperature (°C)
BEEF	
Raw	40-45
Rare	55-60
Medium	65-70
Well done	75-80
VEAL	
Well done	75-85
PORK	
Medium	65-70
Well done	75-85
LAMB	
Well done	79
MUTTON	
Raw	45
Rare	55-60
Medium	65-70
Well done	80
GOAT MEAT	
Medium	70
Well done	82
POULTRY	
Well done	82
FISH	
Well done	65-70



Only use the probe intended for use with your oven. Make sure the probe does not touch the heater during cooking. After the cooking process, the probe will be very hot. Take care to prevent burning.

360° HOT AIR

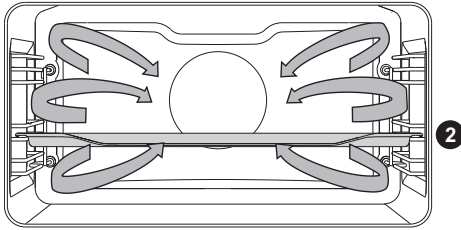

Round heater and the fan will operate. The fan installed in the back wall of the oven cavity makes sure the hot air constantly circulates around the roast or pastry.

Roasting meat:

Use enamel coated, tempered glass, clay, or cast iron pan or tray. Stainless steel trays are not suitable as they strongly reflect the heat.

Provide enough liquid during the cooking process to prevent the meat from burning. Turn the meat during roasting. The roast will remain juicier if you cover it.

Type of food	Weight (g)	Guide (from the bottom)	Temperature (°C)	Cooking time (min)
MEAT				
Pork roast, including skin	1500	1	170-190	90-120
Chicken, whole	1500	2	180-200	70-90
Duck	2000	1	170-190	120-150
Chicken breast	1000	2	190-210	50-60
Stuffed chicken	1500	1	190-210	110-130

Baking pastry

Preheating is recommended.

Biscuits and cookies can be baked in shallow baking sheets on several levels simultaneously (2nd and 3rd).

Note that baking time can differ even with if the baking sheets used are the same. The biscuits in the upper baking sheet may be ready sooner than those in the lower one.

Always place the baking trays on the grid. If you are using the supplied baking sheet, remove the grid.

For even browning, make sure the biscuits are of the same thickness.

Type of food	Guide (from the bottom)	Temperature (°C)	Cooking time (min)
PASTRY			
Sponge cake	1	160-170	30-40
Crumble cake	2	170-180	25-35
Plum cake	1	160-170	30-40
Sponge roll *	2	170-180	15-25
Fruit cake, short crust	1	170-180	50-70
Challah (braided yeast bun)	2	170-180	35-50
Apple strudel	2	180-190	50-60
Pizza *	2	210-220	15-20
Biscuits, short crust *	2	160-170	15-25
Biscuits, pressed *	2	150-160	20-30
Small cakes *	2	150-160	20-30
Cookies, leavened	2	180-190	20-35
Cookies, phyllo dough	2	180-190	20-30
Cream-filled pastry	2	190-200	25-45
FROZEN PRODUCTS			
Apple and cottage cheese strudel	2	180-190	55-70
Pizza	2	190-200	20-35
Fried potatoes, oven-ready	2	210-220	25-40
Croquettes, oven-baked	2	210-220	20-35



Do not insert the deep baking tray into the first guide.

ECO COOKING

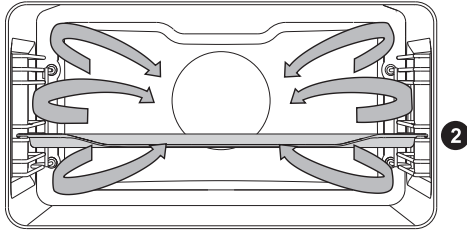

Round heater and the fan will operate. The fan installed in the back wall of the oven cavity makes sure the hot air constantly circulates around the roast or pastry.

Type of food	Guide (from the bottom)	Temperature (°C)	Cooking time (min)
MEAT			
Pork roast, 1 kg	1	200-210	110-130
Pork roast, 2 kg	1	200-210	130-150
Beef roast, 1 kg	1	210-220	100-120
FISH			
Whole fish, 200 g/piece	2	200-210	40-50
Fish fillet, 100 g/piece	2	210-220	25-35
PASTRY			
Pressed cookies	2	180-190	20-30
Small cupcakes	2	190-200	30-35
Sponge roll	2	200-210	15-25
Fruit cake, short crust	1	190-200	55-65
DISHES AU GRATIN			
Potatoes au gratin	2	190-200	40-50
Lasagne	2	200-210	45-55
FROZEN PRODUCTS			
Pommes frites, 1 kg	2	230-240	35-45
Chicken medallions, 0.7 kg	2	220-230	30-40
Fish sticks, 0.6 kg	2	220-230	30-40



Do not insert the deep baking tray into the first guide.

BOTTOM HEATER AND FAN

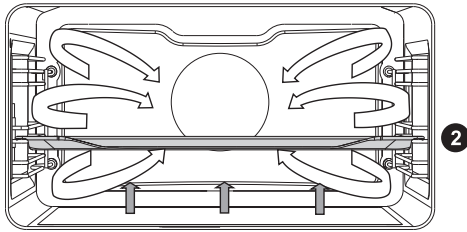

This is used for baking leavened but low-rising pastry and for preserving fruit and vegetables. Use the second guide from the bottom and a rather shallow baking tray to allow the hot air to circulate across the upper side of the dish.

PRESERVATION

Prepare the food to be preserved and jars as usual. Use jars with a rubber sealing ring and a glass cover. Do not use jars with threaded or metal caps or metal tins. Make sure the jars are of equal size, filled with the same contents, and tightly sealed.

Pour 1 litre of hot water into the deep tray (approx. 70°C) and place 6 1-litre jars into the tray. Place the tray into the oven on the second guide.

During preservation, observe the food and cook until the liquid in the jars starts to simmer – when bubbles appear in the first jar.

Type of food	Guide (from the bottom)	Temperature (°C)	Cooking time (min)	Temperature at the start of simmering	Resting time in the oven (min)
FRUIT					
Strawberries (6×1 l)	2	180	40-60	switch off	20-30
Stone fruits (6×1 l)	2	180	40-60	switch off	20-30
Fruit mush (6×1 l)	2	180	40-60	switch off	20-30
VEGETABLE					
Pickled gherkins (6×1 l)	2	180	40-60	switch off	20-30
Beans/carrots (6×1 l)	2	180	40-60	120 °C, 60 min	20-30

AUTOMATIC COOKING OF MEAT - AUTO ROAST MODE A

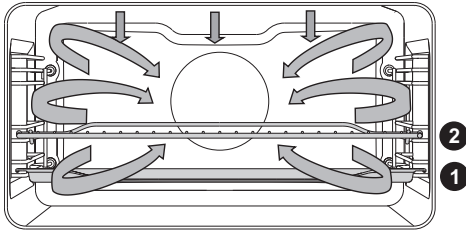

In the Auto Roast mode, the upper heater will operate in combination with the grill heater and the round heater. It is used for roasting all types of meat.

When grilling directly on the grid, smear it with oil to prevent the meat from sticking onto it and insert it into the 2nd guide. Insert a drip tray into the 1st guide. When roasting meat in a baking tray, insert it into the 1st guide.

Type of food	Weight (g)	Guide (from the bottom)	Temperature (°C)	Cooking time (min)	Core temperature (°C)
Beef tenderloin	1000	2	170-190	60-80	55-75*
Chicken, whole	1500	2	180-200	65-85	85-90
Turkey	4000	2	170-190	150-180	85-90
Pork roast	1500	2	170-190	100-120	70-85
Meat loaf	1000	2	170-190	50-65	80-85
Veal	1000	2	170-190	70-90	75-85
Lamb	1000	2	180-200	50-70	75-85
Venison	1000	2	180-200	60-90	75-85
Whole fish	1000	2	170-190	40-50	75-85
Chicken thighs	1000	2	190-210	45-55	85-90

* rare = 55-60 °C; medium = 65-70 °C; well done = 70-75 °C

COMBINED SYSTEMS / STEAM SYSTEM

HOT AIR WITH STEAM

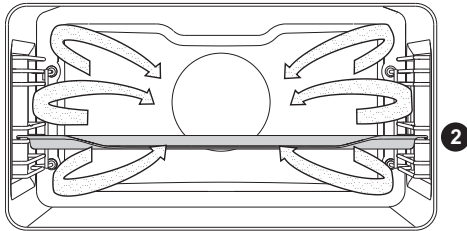

Water from the steam generator enters the oven cavity in the form of steam. In addition, round heater with fan operates to provide continuous circulation of the hot air and steam.

 Fill the water tank with fresh water.

Type of food	Weight (g)	Guide (from the bottom)	Steam intensity	Temperature (°C)	Cooking time (min)
Beef/leg	1000	1	1	170-190	80-110
Beef/tenderloin	1000	1	2	180-200	50-70
Veal/leg	1000	1	1	180-200	80-110
Lamb	1000	1	1	180-200	60-90
Poultry, whole	1500	1	1	180-200	65-85
Poultry/breast	1000	2	3	180-200	50-60
Pork/fillet	1000	1	2	180-200	50-70
Fish	200 g/ piece	2	2	190-210	25-35
Potatoes	1000	2	1	190-210	45-60
Potatoes with broccoli	1000	2	2	180-200	35-50

STEAM

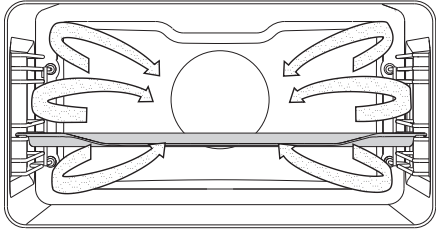

Water from the steam generator enters the oven cavity in the form of steam.



Fill the water tank with fresh water.

Meat

Type of food	Weight (g)	Guide (from the bottom)	Temperature (°C)	Cooking time (min)
Sauerkraut and sausage	700	2	100	30-40
Beef steak	1000	2	100	40-50
Chicken breast	1000	2	100	20-30
Shrimps	1000	2	100	20-30
Fish fillet	500	2	80	15-20
Fish steak	500	2	80	20-25
Whole fish	400	2	100	20-30
Mussels	1000	2	100	15-20
Frankfurter sausage	1000	2	85	10-15

Vegetables

Type of food	Weight (g)	Ratio food:liquid	Guide (from the bottom)	Temperature (°C)	Cooking time (min)
String beans	500	/	2	100	55-65
Beans - seeds	500	1:2	2	100	90-100
Peas	500	/	2	100	20-25
Cauliflower - whole	500	/	2	100	25-35
Cauliflower - chopped	500	/	2	100	15-25
Broccoli - whole	500	/	2	100	20-30
Broccoli - chopped	500	/	2	100	15-25
Carrot - whole	500	/	2	100	25-35
Carrot - diced	500	/	2	100	20-30
Corn	500	/	2	100	25-35
Chickpeas	500	1:2	2	100	85-95
Fennel	500	/	2	100	15-25
Kohlrabi	500	/	2	100	25-35
Red beets - whole	500	/	2	100	65-75
Bell peppers	500	/	2	100	15-20
Radicchio	500	/	2	100	15-20
Brussels sprout	500	/	2	100	20-30
Asparagus	500	/	2	100	15-25
Spinach	500	/	2	100	10-15
Swiss chard	500	/	2	100	15-20
Mixed vegetables	1000	/	2	100	25-35
Cabbage	500	/	2	100	35-45
Chinese cabbage	500	/	2	100	30-40
Eggplant / aubergines	500	/	2	100	10-20
Courgettes	500	/	2	100	10-20
Potatoes, whole	500	/	2	100	30-40
Potatoes, sliced	500	/	2	100	25-35

Pasta/rice/cereals

Type of food	Weight (g)	Ratio food:liquid	Guide (from the bottom)	Temperature (°C)	Cooking time (min)
White rice	200	1:2	2	100	25-35
Brown rice	200	1:2	2	100	55-65
Risotto	Recipe	1:2	2	100	30-40
Pasta	200	1:2	2	100	15-25
Whole grain pasta	200	1:2	2	100	15-25
Millet	250	1:1	2	100	25-35
Gnocchi	500	/	2	100	15-25
Dumplings	500	/	2	100	15-25
Tortellini	500	/	2	100	20-30
Couscous	500	1:1	2	100	15-20
Ravioli	500	/	2	100	15-20

Deserts

Type of food	Weight (g)	Ratio food:liquid	Guide (from the bottom)	Temperature (°C)	Cooking time (min)
Melting chocolate *	200	/	2	50	20-30
Soaking/dissolving gelatin *	1 pack	/	2	50	15-20
Rice pudding	Recipe	1:4	2	100	30-40
Leavened dough	Recipe	/	2	40	25-35
Crème caramel	Recipe	/	2	100	40-50

* Cover the container with a foil

Egg dishes



Type of food	Weight (g)	Guide (from the bottom)	Temperature (°C)	Cooking time (min)
Soft-boiled eggs	200	2	100	10-15
Hard-boiled eggs	200	2	100	15-20
Poached eggs	200	2	100	13-17
Scrambled eggs	200	2	100	10-15
Omelette with bacon	Recipe	2	100	15-20

Fruit

Type of food	Weight (g)	Guide (from the bottom)	Temperature (°C)	Cooking time (min)
Apple slices	500	2	100	5-15
Apricot slices	500	2	100	5-15
Cherries	500	2	100	10-15
Gooseberries	500	2	100	5-15
Pear - chunks	500	2	100	5-15
Plums	500	2	100	5-15
Rhubarb	500	2	100	5-15
Nectarines	500	2	100	5-10

Defrosting

Type of food	Weight (g)	Guide (from the bottom)	Temperature (°C)	Defrosting time (min)
Frozen meat	500	2	50	40-50
Frozen poultry	1500	2	50	50-60
Frozen fish, 200 g / piece	1000	2	50	35-45
Frozen fruit	500	2	50	10-20
Frozen ready-made meals	1000	2	60	45-60

 To dry the inside of the oven, set hot air and lower heater  to 170 °C for 15 minutes. After the end of the programme leave the oven door open for at least two minutes to let the steam out and let the inside of the appliance become dry.

MAINTENANCE & CLEANING



Be sure to unplug the appliance from the power supply and wait for the appliance to cool down.

Children should not clean the appliance or perform maintenance tasks without proper supervision.

Aluminium finish

Clean the aluminium finish with non-abrasive liquid cleaners intended for such surfaces. Apply the cleaner onto a wet cloth and clean the surface. Then, rinse the surface with water. Do not apply the cleaner directly onto the aluminium finish.

Do not use abrasive cleaners or sponges.

Note: The surface should not come into contact with oven cleaning sprays as this may result in visible and permanent damage.

Stainless steel sheet front side of the housing

(depending on the model)

Clean this surface only with a mild detergent (soapsuds) and a soft sponge that will not scratch the finish. Do not use abrasive cleaners or cleaners containing solvents as they may damage the housing finish.

Lacquer-coated surfaces and plastic parts

(depending on the model)

Clean the knobs and door handle with a soft cloth and liquid cleaners intended for smooth lacquer-coated surfaces. You may also use cleaners intended for such surfaces as instructed by the cleaner manufacturer.



The aluminium-coated surfaces should not come into contact with oven cleaning sprays as this may result in visible and permanent damage.

CONVENTIONAL OVEN CLEANING

You may use the standard cleaning procedure to clean stubborn dirt in the oven (using cleaners or an oven spray). After such cleaning, rinse the cleaner residues thoroughly.

Clean the oven and the accessories after each use to prevent the dirt from burning into the surface. The easiest way to remove fat is by using warm soapsuds while the oven is still warm.

With stubborn dirt and grime, use conventional oven cleaners. Rinse the oven thoroughly with clean water to remove all cleaner residue.

Never use aggressive cleaners, abrasive cleaners, abrasive sponges, stain and rust removers etc.

Clean the accessories (baking sheets and trays, grids etc.) with hot water and detergent.

The oven, the oven cavity and the baking trays are lined with a special enamel coating for a smooth and resistant surface. This special coating makes cleaning at room temperature easier.

USING THE STEAM CLEAN FUNCTION TO CLEAN THE OVEN

Before running the Steam Clean program, add fresh water into the water tank.

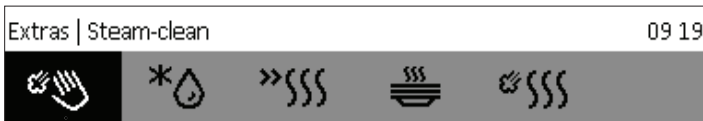

Choose "Extra/Additional Functions" in the main menu and select the Steam Clean symbol. Confirm the setting by pressing on the KNOB.

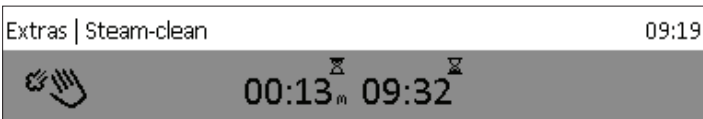

Press the START key.



After starting the program, wait until the time indicated on the screen expires (13 minutes).

When the Steam Clean program is complete, wait for the oven to cool down sufficiently so that you can wipe the oven interior safely, without burning yourself.



Use the Steam Clean function after the oven has fully cooled down.

CLEANING THE STEAM SYSTEM

Cleaning depends on the water hardness level.

Water hardness	°N	Estimated use of water in litres before descaling is required	Number of coloured stripes on the test strip
Soft	0-3 dH	100	4 green stripes
Slightly hard	3-7 dH	70	1 red stripe
Medium hard	7-14 dH	50	2 red stripes
Hard	14-21 dH	35	3 red stripes
Very hard	>21 dH	25	4 red stripes

We recommend using the descaling agent as it delivers quality results of the steam system cleaning process.

The following note will appear on the display: **"Please run the descaling procedure."** The notes on the display will guide you through the descaling procedure.

1. Add the descaling agent into the water tank (diluted in water at a ratio of 1:8).
2. Descaling procedure is in progress.
3. Descaling procedure complete. Please remove the liquid, rinse the water tank and add fresh water for the rinsing process.
4. Rinsing process complete. Clean the tank and wipe the oven.
Also clean the filter foam (see chapter CLEANING THE FILTER FOAM)

CLEANING THE FILTER FOAM



Any time you clean the water tank or descale the appliance, also clean the filter foam.

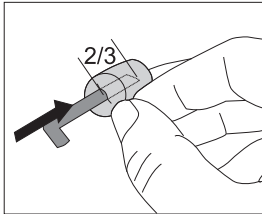
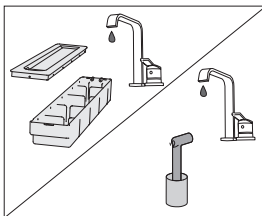
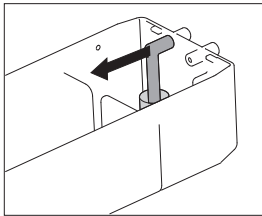
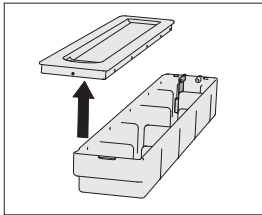
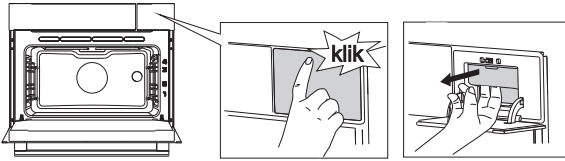

1 Open the water tank cover.

2 Remove the inlet pipe from the pipe attachment.

3 Clean the inlet pipe with the filter foam under running water. Rinse the foam clean so that there are no visible impurities on it. Thus, you will make sure the appliance operates correctly and preserve the fresh flavour and smell of food.

 If the filter foam is detached from the inlet pipe, replace it by inserting the pipe to the depth of two thirds of the overall foam length.

REMOVING AND CLEANING THE WIRE GUIDES

Only use conventional cleaners to clean the guides.

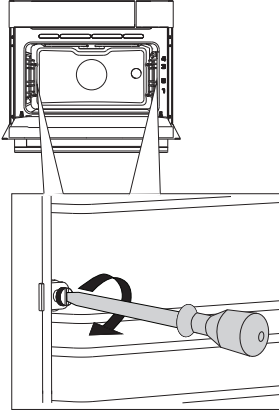

1 Undo the screw.

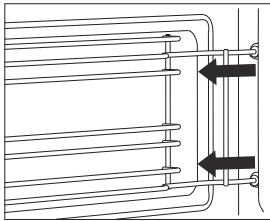

2 Remove the guides from the holes in the back wall.



After cleaning, re-tighten the screws on the guides with a screwdriver.

REMOVING AND INSERTING THE OVEN DOOR

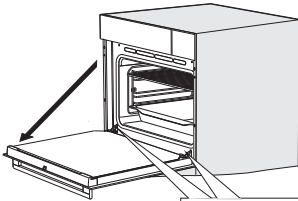

1 First, fully open the door (as far as it will go).

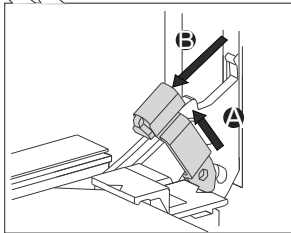

2 Slightly lift the hinge retainers and pull the door towards you.

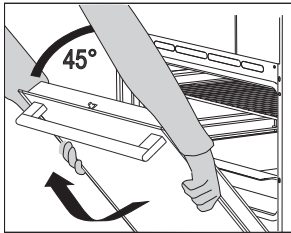

3 Slowly close the door to a 45-degree angle (relative to the position of the fully closed door); then, lift the door and pull it out.



To replace the door, observe the reverse order. If the door does not open or close properly, make sure the notches on the hinges are aligned with the hinge beds.



When replacing the door, always make sure the hinge retainers are correctly placed in the hinge beds to prevent sudden closing of the main hinge which is connected to a strong main spring. If the main spring is engaged, there is a risk of injury.

DOOR LOCK (depending on the model)

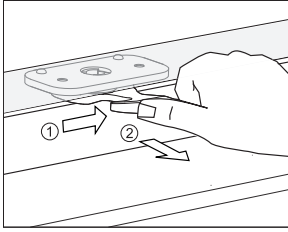

To open it, gently push it to the right with your thumb and pull the door outwards at the same time.

 **When the oven door is closed, the door lock automatically returns to the initial position.**

DEACTIVATING AND ACTIVATING THE DOOR LOCK

 **The oven should be cooled down completely.**

First, open the oven door.

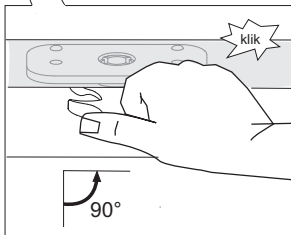
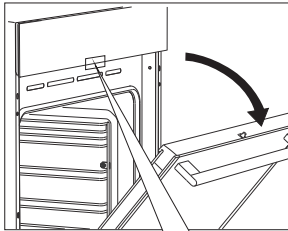

Push the door lock to the right by 90° with your thumb until you feel a click. The door lock is not deactivated.

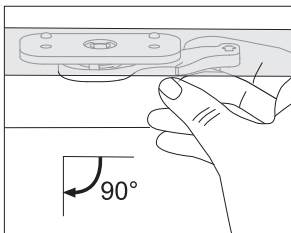

To reactivate the door lock, open the oven door and use your right-hand index finger to pull the lever towards you.

SOFT DOOR OPENING (depending on the model)

Oven door is fitted with a system that dampens the door opening force, starting at the 75-degree angle.

SOFT DOOR CLOSING (depending on the model)

Oven door is fitted with a system that dampens the door closing force, starting at the 75-degree angle. It allows simple, quiet, and smooth closing of the door. A gentle push (to a 15-degree angle relative to the closed door position) is enough for the door to close automatically and softly.



If the force applied to close the door is too strong, the effect of the system is reduced or the system will be bypassed for safety.

REMOVING AND INSERTING THE OVEN DOOR GLASS PANE (depending on the model)

Oven door glass pane can be cleaned from the inside, but it has to be removed first. Remove the oven door (see chapter "Removing and replacing the oven door").

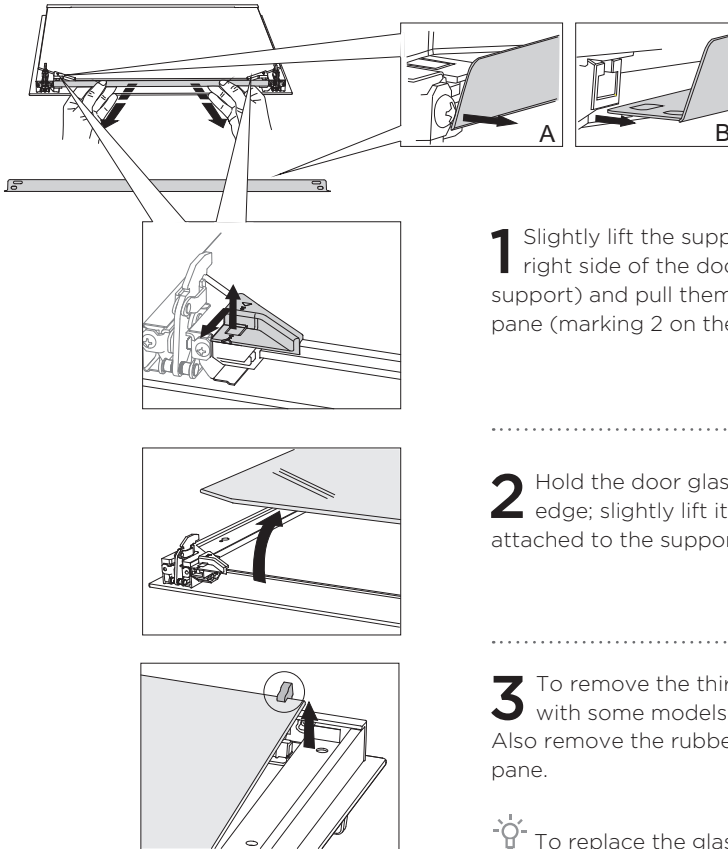

- 1** Slightly lift the supports on the left and right side of the door (marking 1 on the support) and pull them away from the glass pane (marking 2 on the support).

- 2** Hold the door glass pane by the lower edge; slightly lift it so that it is no longer attached to the support; and remove it.

- 3** To remove the third glass pane (only with some models), lift and remove it. Also remove the rubber seals on the glass pane.

 To replace the glass pane, observe the reverse order. The markings (semicircle) on the door and the glass pane should overlap.

REPLACING THE BULB

The bulb is a consumable and therefore not covered by warranty. Before changing the bulb, remove the trays, the grid, and the guides.

Use a Phillips (cross) screwdriver. (Halogen lamp: G9, 230 V, 25 W)

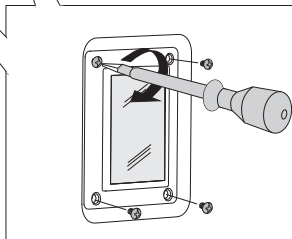
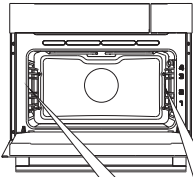

1 Use a flat screwdriver to release the bulb cover and remove it.

NOTE: Make sure not to damage the enamel.

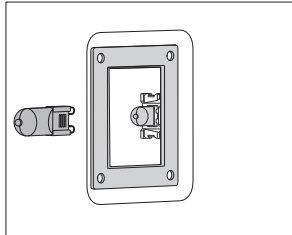

2 Remove the halogen bulb.

 Use protection to avoid burns.

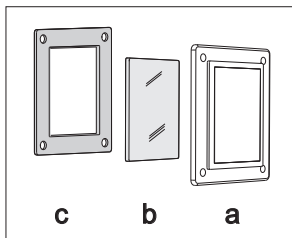

 There is a gasket on the cover which should not be removed. Do not allow the gasket to be detached from the cover. The gasket should fit correctly onto the oven cavity wall.

c

b

a

TROUBLESHOOTING TABLE

Problem/error	Solution
There is no response of the sensors; the display is frozen.	Disconnect the appliance from the power mains for a few minutes (undo the fuse or switch off the main switch); then, reconnect the appliance and switch it on.
The main fuse in your home trips often.	Call a service technician.
The oven lighting does not work.	The process of changing the light bulb is described in the chapter
The pastry is underdone.	Cleaning and Maintenance.
Error code is displayed: ERRXX ... * XX denotes the number/code of the error.	<ul style="list-style-type: none">• There is an error in the electronic module operation. Disconnect the appliance from the power mains for a few minutes. Then, reconnect it and set the time of day.• If the error is still indicated, call a service technician.
Water is not pumped into the steam system.	<ul style="list-style-type: none">• Check the water level in the water tank.• Not enough water in the water tank• Make sure the tubes on the back of the water tank and the holes are not clogged.

If the problems persist despite observing the advice above, call an authorized service technician. Repair or any warranty claim resulting from incorrect connection or use of the appliance shall not be covered by the warranty. In this case, the user will cover the cost of repair.



Before the repair, disconnect the appliance from the power mains (by removing the fuse or by removing the plug from the wall outlet).

DISPOSAL



Packaging is made of environmentally friendly materials that can be recycled, disposed of, or destroyed without any hazard to the environment. To this end, packaging materials are labelled appropriately.

The symbol on the product or its packaging indicates that the product should not be treated as normal household waste. The product should be taken to an authorized collection center for waste electric and electronic equipment processing.

Correct disposal of the product will help prevent any negative effects on the environment and health of people which could occur in case of incorrect product removal. For detailed information on removal and processing of the product, please contact the relevant municipal body in charge of waste management, your waste disposal service, or the store where you bought the product.

We reserve the right to any changes and errors in the instructions for use.

COMBI STEAM_DM



en (05-18)