

GB

IE

MT

**DETAILED  
INSTRUCTIONS FOR USE  
OF A COMBINED  
MICROWAVE OVEN**

**gorenje**

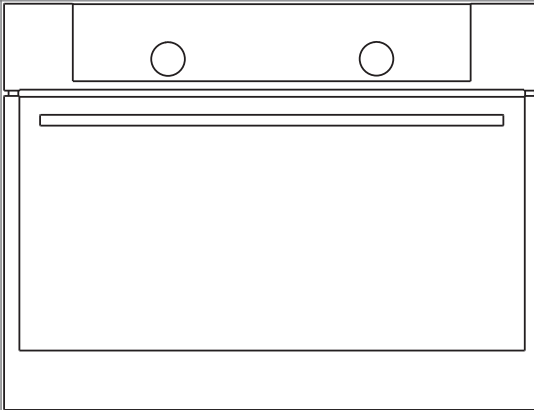

We thank you for your trust and the purchase of our appliance.

This detailed instruction manual is supplied to make the use of this product easier. The instructions should allow you to learn about your new appliance as quickly as possible.

Make sure you have received an undamaged appliance. If you do find transport damage, please contact the seller from which you purchased the appliance, or the regional warehouse from which it was supplied. The telephone number can be found on the invoice or on the delivery note.

Instructions for installation and connection are supplied on a separate sheet.

Instructions for use are also available at our website:

[www.gorenje.com](http://www.gorenje.com) / < <http://www.gorenje.com> />



Important information



Tip, note

# CONTENTS

---

<b>4 IMPORTANT SAFETY INSTRUCTIONS</b> 8 Before connecting the appliance: .....	<b>INTRODUCTION</b>
<b>9 COMBINED MICROWAVE OVEN</b> 12 Control unit 14 Technical specifications	
<b>15 BEFORE USING THE APPLIANCE FOR THE FIRST TIME</b>	<b>PREPARING THE APPLIANCE FOR THE FIRST USE</b>
<b>16 STEPS OF THE COOKING PROCESS (1-6)</b> 16 Step 1: SWITCHING ON AND SETTINGS 17 Step 2: CHOOSING THE COOKING SYSTEM 19 Step 3: CHOOSING THE SETTINGS 23 Step 4: SSELECTING ADDITIONAL FUNCTIONS 25 Step 5: STARTING THE COOKING PROCESS 25 Step 6: SWITCHING OFF THE OVEN .....	<b>COOKING STEPS</b>
<b>26 DESCRIPTIONS OF SYSTEMS (COOKING MODES) AND COOKING TABLES</b>	
<b>44 MAINTENANCE &amp; CLEANING</b> 45 Conventional oven cleaning 46 Using the aqua clean function to clean the oven 47 Removing and cleaning the wire guides 48 Replacing the bulb	<b>MAINTENANCE &amp; CLEANING</b>
<b>49 TROUBLESHOOTING TABLE</b> .....	<b>TROUBLE-SHOOTING</b>
<b>50 DISPOSAL</b>	

# IMPORTANT SAFETY INSTRUCTIONS

---



**CAREFULLY READ THE INSTRUCTIONS AND SAVE THEM FOR FUTURE REFERENCE.**

This appliance can be used by children aged from 8 years and above and persons with reduced physical, sensory or mental capabilities or lack of experience and knowledge if they have been given supervision or instruction concerning use of the appliance in a safe way and understand the hazards involved. Children shall not play with the appliance. Cleaning and user maintenance shall not be made by children without supervision.

Children should be supervised to ensure that they do not play with the appliance.

**WARNING:** The appliance and its accessible parts become hot during use. Care should be taken to avoid touching heating elements. Children less than 8 years of age shall be kept away unless continuously supervised.

**WARNING:** Accessible parts may become hot during use. Young children should be kept away.

**WARNING:** Accessible parts will become hot when in use. To avoid burns and scalds children should be kept away.

During use the appliance becomes hot. Care should be taken to avoid touching heating elements inside the oven.

Only use the temperature probe recommended for use in this oven.

**WARNING:** Ensure that the appliance is switched off before replacing the lamp to avoid the possibility of electric shock.

Do not use harsh abrasive cleaners or sharp metal scrapers to clean the oven door glass/ the glass of hinged lids of the hob (as appropriate), since they can scratch the surface, which may result in shattering of the glass.

Do not use steam cleaners or high pressure cleaners to clean the appliance as this may result in an electric shock.

Means for disconnection must be incorporated in the fixed wiring in accordance with the wiring rules.

If the supply cord is damaged, it must be replaced by the manufacturer, its service agent or similarly qualified persons in order to avoid a hazard (only for appliances supplied with connection cord) .

The appliance must not be installed behind a decorative door in order to avoid overheating.

The appliance is intended for household use. Do not use it for any other purpose, such as room heating, drying of pets or other animals, paper, fabrics, herbs etc. As this may lead to injury or fire hazard.

Oven door become very hot during operation. A third glass is installed for extra protection, reducing the temperature of the outside surface (only with some models).

The appliance may only be connected to the power mains by an authorized service technician or expert. Tampering with the appliance or nonprofessional repair thereof may result in risk of severe injury or damage to the product.

Oven door hinges may be damaged when under excessive load. Do not place heavy pans on open oven door and do not lean against open oven door when cleaning the oven cavity. Never stand on the open oven door and do not let children to sit on it.

If the power cords of other appliances located near this appliance are caught in the oven door, they may be damaged, which may in turn result in a short circuit. Therefore, keep the power cords of other appliances at a safe distance.

Do not lift the appliance by holding it by the door handle.

Appliance operation is safe with and without tray guides.

Do not line the oven walls with aluminium foil and do not place baking trays or other cookware on the oven bottom. Aluminium foil would prevent air circulation in the oven, hinder the cooking process, and ruin the enamel coating.

Make sure the vents are never covered or obstructed in any other way.

## Safe use of the microwave oven

WARNING: When the appliance is operated in the combination mode, children should only use the oven under adult supervision due to the temperatures generated.

WARNING: If the door or door seals are damaged, the oven must not be operated until it has been repaired by a competent person.

WARNING: It is hazardous for anyone other than a competent person to carry out any service or repair operation that involves the removal of a cover which gives protection against exposure to microwave energy.

WARNING: Liquids and other foods must not be heated in sealed containers since they are liable to explode.

This appliance is intended to be used in household and similar applications such as:

- staff kitchen areas in shops, offices and other working environments;
- farm houses;
- by clients in hotels, motels and other residential environments;
- bed and breakfast type environments.

Only use utensils suitable for use in microwave ovens.

Metallic containers for food and beverages are not allowed during microwave cooking.

When heating food in plastic or paper containers, keep an eye on the oven as such packaging may ignite.

Microwave heating of beverages can result in delayed eruptive boiling; therefore, care must be taken when handling the container. To prevent eruptive boiling, place a non-metal object (e.g. a wooden, glass or plastic spoon) into the container before you start heating up beverage.

The contents of feeding bottles and baby food jars shall be stirred or shaken and the temperature checked before consumption, in order to avoid burns.

Eggs in their shell and whole hard-boiled eggs should not be heated in microwave ovens since they may explode, even after microwave heating has ended.

If smoke is observed, switch off or unplug the appliance and keep the door closed in order to stifle any flames.

The microwave oven is intended for heating food and beverages. Drying of food or clothing and heating of warming pads, slippers, sponges, damp cloth and similar may lead to risk of injury, ignition or fire.

The oven should be cleaned regularly and any food deposits removed.

Failure to maintain the oven in a clean condition could lead to deterioration of the surface that could adversely affect the life of the appliance and possibly result in a hazardous situation.

The appliance must be operated with any cabinet door open.

**Heed** the minimum distance between the upper edge of the oven and the nearest object above it.

The microwave oven is intended for heating food and beverages. Drying food or clothing and heating of hot packs or pads, slippers, sponges, moist cloths etc. may result in injury, ignition, or fire.

**Always use oven mitts** to remove dishes from the oven. Some pots, pans, or trays absorb the heat of foods and therefore become very hot.

**Make sure** to only use the cookware that is suitable for use in a microwave oven. Do not use cookware made of steel or cookware with golden or silver rims.

**Do not leave any accessories or utensils** in your oven when it is off. To avoid damage, do not switch on an empty oven.

Do not use receptacles made of porcelain, ceramics, or clay, if there are pores in the material or if the inside is not glazed. Once heated up, the moisture that would penetrate these pores could cause cracking. Only use the cookware intended for use in a microwave oven.

**Always read** and observe the instructions for heating in a microwave oven, specified on the food packaging.

**Be careful** when heating alcohol-containing food, as a combustible mixture of alcohol and air may form inside the oven. Open the door carefully.

**When using the microwave** or the combined microwave and convection functions, use of metallic cookware, forks, spoons, knives or metal clips/fasteners for frozen food is not recommended. After heating, stir the food or leave it to rest until the heat is evenly distributed.

Do not connect the appliance to power supply if an ELCB (earth-leakage circuit breaker) is installed in the power supply circuit.

## BEFORE CONNECTING THE APPLIANCE:



Carefully read the instructions for use before connecting the appliance. Repair or any warranty claim resulting from incorrect connection or use of the appliance shall not be covered by the warranty.



# COMBINED MICROWAVE OVEN

## (DESCRIPTION OF THE OVEN AND EQUIPMENT - DEPENDING ON THE MODEL)

The figure represents one of the built-in appliance models. Since the appliances for which these instructions were drawn up may have different equipment, some functions or equipment may be described in the manual that may not be present in your appliances.

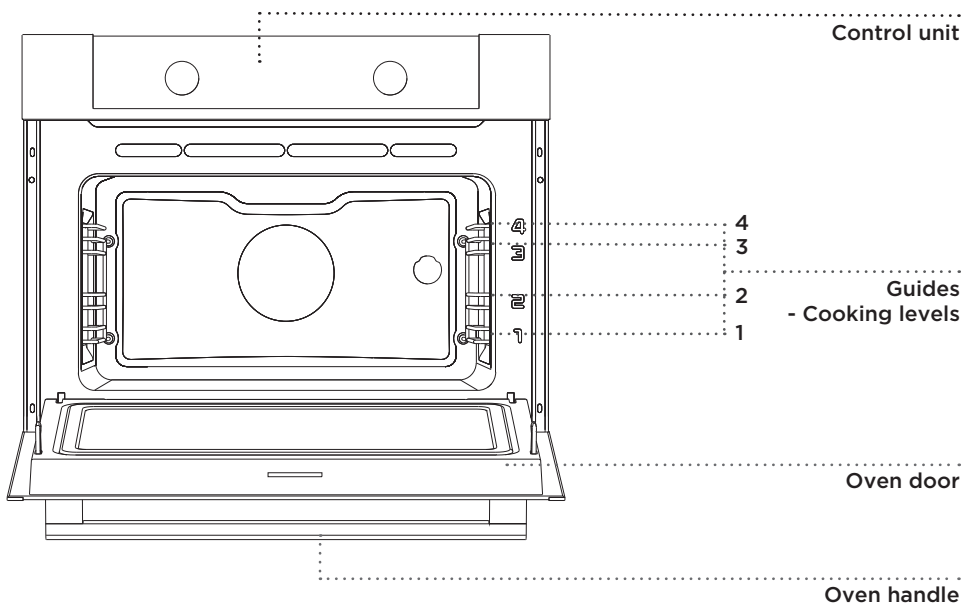

## WIRE GUIDES

Wire guides allow preparation of the food on four levels (please note that the levels/guides are counted from the bottom up).

Guides 3 and 4 are intended for grilling, and guide 1 is used with microwave systems when food is prepared in a glass baking dish.

## OVEN DOOR SWITCH

The switches deactivate oven heating, the fan, and the microwaves when the oven door is opened during the cooking process. When the door is closed, the switches turn the heaters and microwaves back on.

## COOLING FAN

The appliance is fitted with a cooling fan that cools the housing and the appliance control panel.

## EXTENDED OPERATION OF THE COOLING FAN

After the oven is switched off, the cooling fan continues to operate for a short while in order to provide additional cooling for the oven. (Extended cooling fan operation depends on the temperature in the center of the oven.)

## OVEN EQUIPMENT AND ACCESSORIES

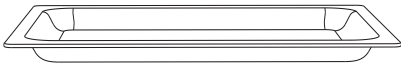

**GLASS BAKING DISH** is used for cooking with all oven systems and for cooking with microwaves. It can also be used as a serving tray.



**Never use the grid, the shallow baking sheet or the deep baking tray or any other metal part or accessory when operating a system with microwaves!**



The **GRID** is used for grilling or as support for a pan, baking tray or baking dish with the food.



There is a safety latch on the grid. Therefore, the grid has to be lifted slightly at the front when pulling it out from the oven.

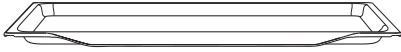

The **SHALLOW BAKING SHEET** is used for baking pastry and cakes.

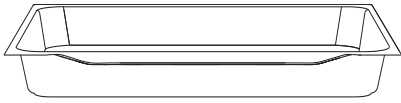

The **DEEP BAKING TRAY** is used for roasting meat and baking moist pastry. It can also be used as a drip tray.



Never place the deep baking tray in the first guide during the cooking process, except when grilling food or using the roasting spit and you are only using the deep tray as a drip tray.



**As baking accessories heat up, their form may change. This does not affect their functionality and their original form will be restored when they cool down.**

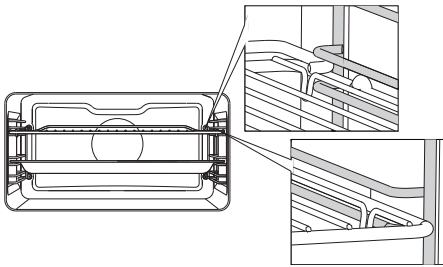

The grid or the tray should always be inserted into the groove between the two wire profiles.



**Never use the grid, the shallow baking sheet or the deep baking tray or any other metal part or accessory when operating a system with microwaves!**

# CONTROL UNIT

(DEPENDENT ON THE MODEL)

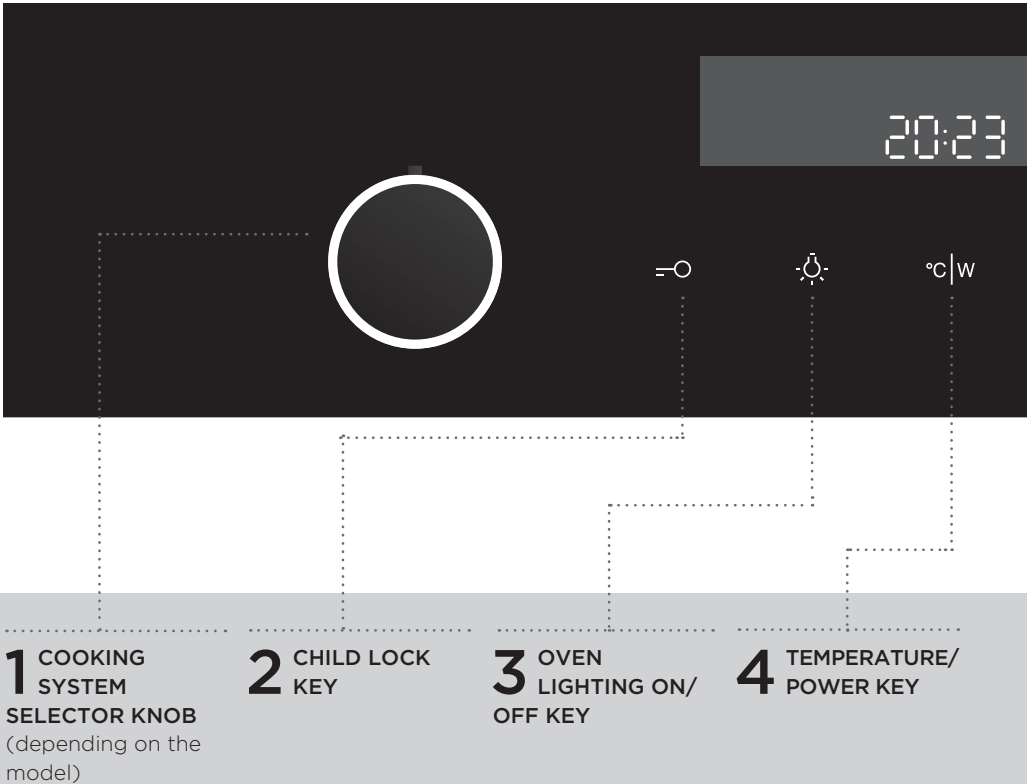

**NOTE:**

Symbols of cooking systems may be located on the knob or on the front panel (depending on the appliance model).

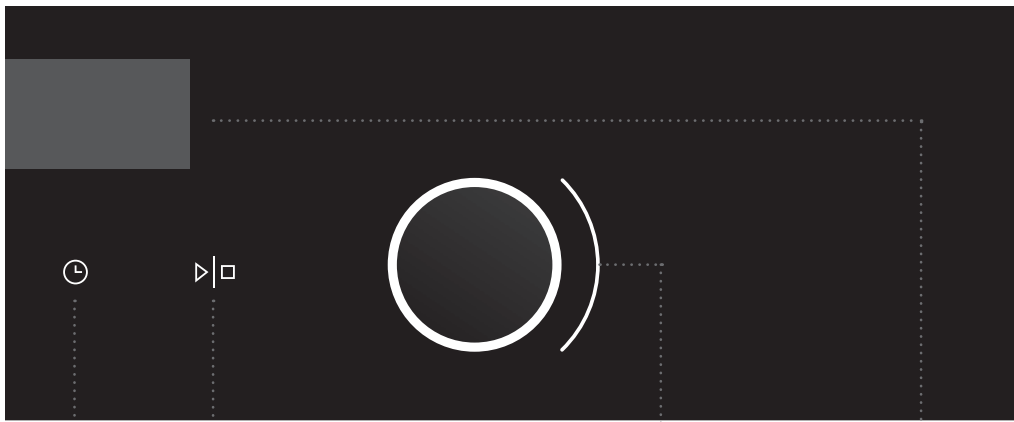

**5** ELECTRONIC PROGRAM TIMER

- Cooking duration
- End of cooking
- Alarm
- Clock

**6** START/STOP KEY  
Use this key to start or stop the program.

**7** SETTINGS KNOB (-/+)  
Use this knob to set the time, temperature and microwave power.

**8** COOKING INFORMATION AND CLOCK DISPLAY

**NOTE:**

The keys will respond better if you touch them with a larger area of your fingertip. Each time you press a key, a short acoustic signal will be sounded.

# TECHNICAL SPECIFICATIONS

(DEPENDING ON THE MODEL)

XXXXXX	220-240V ~	$P_{n_{max}}$ : 3.1 kW	TN XXXXX
TYPE: XXXXXXX	220V-240V, 50/60Hz	Freq. : 2,45 GHz	
ART. Nr:			
SER. Nr: XXXXXXX			

The rating plate indicating the basic information about the appliance is located at the edge of the oven and it is visible when the oven door is opened.

# BEFORE USING THE APPLIANCE FOR THE FIRST TIME

Upon receiving the appliance, remove all parts, including any transport equipment, from the oven.

Clean all accessories and utensils with warm water and regular detergent. Do not use any abrasive cleaners.

When the oven heats up for the first time, the characteristic smell of a new appliance will be emitted. Ventilate the room thoroughly during the first use.

## MICROWAVE FUNCTION

Microwaves are used for **cooking, roasting, and defrosting of food**. They allow quick and efficient cooking without changing the colour or shape of the food.

Microwaves are a type of electromagnetic radiation. Such radiation is commonly found in our environment in the form of radio-electric waves, light or infrared rays. Their frequency is in the 2,450 MHz range.

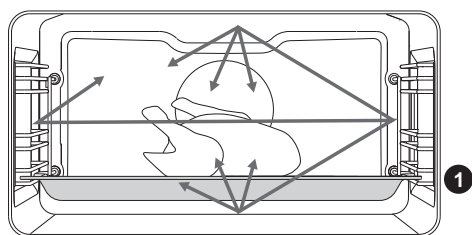

Their behaviour:

- They are reflected by metals.
- They travel through all other materials.
- They are absorbed by water, fat and sugar molecules.

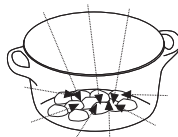
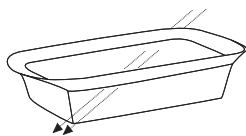

When food is exposed to microwaves, the molecules begin to move rapidly, thereby generating heat.

The microwaves penetrate approximately 2.5 centimeters deep into the food. If the food is thicker, the core of the food will be cooked by conduction, as in conventional cooking.



**Never use or activate a microwave system if the oven is empty.**

# STEPS OF THE COOKING PROCESS (1-6)

---

## STEP 1: SWITCHING ON AND SETTINGS

After connecting your appliance or after an extended power outage, 12:00 will flash on the display and the symbol will light up.

Set the time of day.

### SETTING THE CLOCK

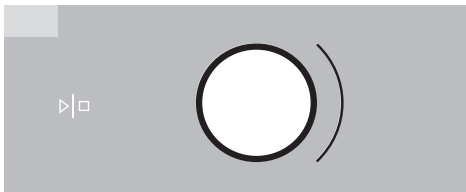

**1** Rotate the SETTINGS KNOB (-/+ ) and first set the minutes; then, the cursor will switch to hours. After three seconds, the settings will be saved.

 Turning the knob farther to the right or to the left will change the settings more quickly.

.....

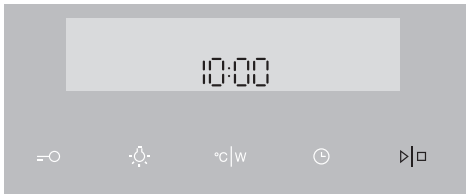

**2** Confirm by pressing START/ STOP. If nothing is pressed within the next three seconds, the setting will be stored automatically.

 The oven will also work if the clock is not set. However, timer functions are not available in this case (see chapter: SETTING THE TIMER FUNCTIONS).

After a few minutes of idling, the appliance will switch to standby mode.

### CHANGING THE CLOCK SETTING

Clock settings may be changed when no timer function is activated.

Press the key to  set the current time. Confirm by pressing START/ STOP.





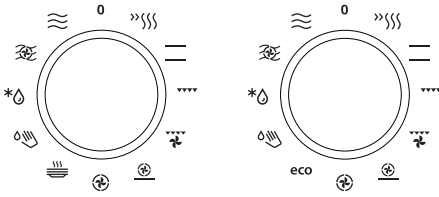







## STEP 2: CHOOSING THE COOKING SYSTEM



Rotate the knob (left and right) to select 0 COOKING SYSTEM (see program table). The selected icon will appear on the display.

 Settings can also be changed during operation.

SYSTEM	DESCRIPTION	SUGGESTED TEMPERATURE (°C)	SUGGESTED POWER (W)
<b>COOKING SYSTEMS</b>			
	<b>RAPID PREHEAT</b> Use this function if you wish to heat the oven to the desired temperature as quickly as possible. This function is not appropriate for cooking food. When the oven heats up to the desired temperature, the heating process is completed.	160	-
	<b>UPPER AND BOTTOM HEATER</b> The heaters in the bottom and in the ceiling of the oven cavity will radiate heat evenly into the oven interior. Pastry or meat can only be baked/roasted at a single height level.	200	-
	<b>GRILL</b> The upper heater and the grill heater will operate. The heat is radiated directly by the grill heater installed in the oven ceiling. To boost the heating effect, the upper heater is activated as well. This combination is used for grilling a smaller amount of open sandwiches, meat or beer sausages, and for toasting bread.	240	-
	<b>GRILL WITH FAN</b> Grill heater and the fan will operate. This combination is used to grill meat and to roast larger chunks of meat or poultry at a single height level. It is also appropriate for dishes au gratin and for browning to a crispy crust.	170	-
	<b>HOT AIR AND BOTTOM HEATER</b> The bottom heater, the round heater, and the hot air fan will operate. This is used to bake pizza, moist pastry, fruitcakes, leavened dough and shortcrust on several levels simultaneously.	200	-
	<b>HOT AIR</b> Round heater and the fan will operate. The fan installed in the back wall of the oven cavity makes sure the hot air constantly circulates around the roast or pastry. This mode is used for roasting meat and baking pastry at several levels simultaneously.	180	-

SYSTEM	DESCRIPTION	SUGGESTED TEMPERATURE (°C)	SUGGESTED POWER (W)
	<b>PLATE WARMER</b> Use this function to reheat your dinnerware (plates, cups) before serving food in it to keep the food warm longer.	60	-
<b>eco</b>	<b>ECO COOKING <sup>1)</sup></b> In this mode, power consumption during the cooking process is optimized. This mode is used for roasting meat and baking pastry.	180	
	<b>AQUA CLEAN</b> Only the microwaves generate the heat. Use this function to remove stains and food residues from the oven. The program takes 4 minutes.	-	750
<b>AUTOMATIC SYSTEM</b>			
	<b>DEFROSTING</b> The air circulates with no heaters activated. Only the fan will be activated. This is used to slowly thaw frozen food. Using microwaves to defrost frozen food. Automatic programs also allow defrosting with microwaves (A1 to A5).	-	-
<b>COMBINED SYSTEMS/MICROWAVE SYSTEMS</b>			
	<b>HOT AIR AND MICROWAVES</b> Use this for all types of meat, stews, vegetables, pies, cakes, bread, and dishes au gratin (i.e. food that require longer cooking time).	160	600
	<b>MICROWAVES</b> Microwaves are used for cooking and defrosting. They allow quick and efficient cooking without changing the colour or shape of the food.	-	750

<sup>1)</sup> It is used for determining the energy efficiency class pursuant to the EN 60350-1 standard.

In this mode, the actual temperature in the oven is not displayed due to a special appliance operation algorithm and use of residual heat.

# STEP 3: CHOOSING THE SETTINGS

Each cooking system features basic or default settings which can be adjusted.

Adjust the settings by pressing the relevant key (before pressing the START/STOP key). Some settings are not available with some programs; an acoustic signal will remind you of such cases.

## CHANGING THE COOKING TEMPERATURE AND MICROWAVE POWER

Only set the power (W) in combined systems and systems with microwaves.

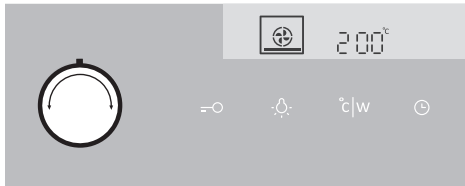

**1** Select the COOKING SYSTEM. Selected icon will appear on the display and PRESET TEMPERATURE will flash.



**2** Select the COOKING SYSTEM. Selected icon will appear on the display and PRESET TEMPERATURE will flash.



**3** Touch the TEMPERATURE KEY twice to set the power. Power in watts (W) will appear on the display. Rotate the SETTINGS KNOB (-/+ ) and set the power.

 Maximum temperature or power is limited in some systems.

After switching on the appliance by pressing the START key, temperature and microwave power will alternate on the display (only with combined systems).

The symbol °C/W will flash on the display until the selected value is reached.

POWER LEVEL	USE
1000 W	<ul style="list-style-type: none"> <li>• Quickly reheating beverages, water and dishes containing a large volume of liquid.</li> <li>• Cooking dishes with high water content (soups, sauces etc.).</li> </ul>
750 W	<ul style="list-style-type: none"> <li>• Cooking fresh or frozen vegetables.</li> </ul>
600 W	<ul style="list-style-type: none"> <li>• Melting chocolate.</li> <li>• Cooking fish and seafood; reheating on two levels.</li> <li>• Cooking dried beans at low heat.</li> <li>• Reheating and cooking of delicate egg-based dishes.</li> </ul>
360 W	<ul style="list-style-type: none"> <li>• Low-heat cooking of dairy products or jams.</li> </ul>
180 W	<ul style="list-style-type: none"> <li>• Manual defrosting; softening butter or ice cream.</li> </ul>
90 W	<ul style="list-style-type: none"> <li>• Defrosting cream-filled pastry.</li> </ul>

# TIMER FUNCTIONS

First rotate the COOKING SYSTEM SELECTOR KNOB; then, set the temperature.

Touch the TIMER key several times to select the symbol.

The icon for the selected timer function will light up and the adjustable cooking start/end time will flash on the display. Other icons are dimly lit.

Press START to start the cooking process. ELAPSED COOKING TIME will be displayed.



Timer function display



## Setting the cooking time

In this mode, you can define the duration of oven operation (cooking time). Set the desired cooking time. First set the minutes, then the hours. Icon and cooking time are displayed on the display unit.



## Setting the delayed start

In this mode, you may specify the duration of the cooking process (cooking time) and the time when you wish the cooking process to stop (end time). Make sure the clock is accurately set to current time.

Example:

Current time: noon

Cooking time: 2 hours

End of cooking: 6 pm

First set the OPERATION DURATION (2 hours). Touch the CLOCK button again and select END OF OPERATION. The display automatically shows a flashing sum of the time of day and duration of operation of the oven (14:00).

Set the time for the end of baking (18:00)

Press START to start the cooking process. The timer will wait for the time to start the cooking process and the symbol will be lit up. The oven automatically switches on (at 4 pm) and stops operating and the selected time (at 6 pm).



## Setting the minute minder

The minute minder can be used independently of the oven operation. The longest possible setting is 24 hours. During the last minute, the minute minder is displayed in seconds.



After the set time expires, the oven will automatically stop operating (end of cooking). An acoustic signal will be heard which you may turn off by touching any key. After one minute, the acoustic signal will be switched off automatically.

All timer functions can be cancelled by setting the time to "0".

After a few minutes of idling, the appliance will switch to standby mode.

## STEP 4: SELECTING ADDITIONAL FUNCTIONS

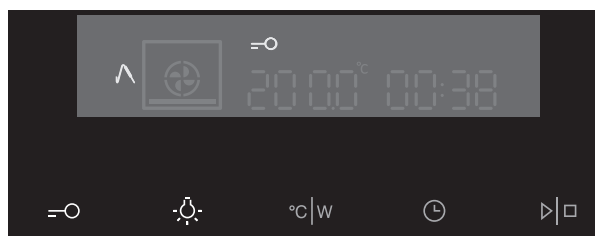

Activate/deactivate the functions by pressing the desired key or a combination of keys.

 Some functions are not available with some systems; an acoustic signal will indicate of such cases.

---

### CHILD LOCK

Activate it by touching the CHILD LOCK key. The "key" icon will light up on the display. Touch the key again to deactivate the child lock. The icon on the display will disappear.

If the child lock is activated with no timer function engaged (only clock is displayed), then the oven will not operate.

If the child lock is activated after a timer function has been set, then the oven will operate normally; however, it will not be possible to change the settings.

When the child lock is activated, systems (cooking modes) or additional functions cannot be changed. The only possible change is to end the cooking process by rotating the selector knob to "0". Child lock will remain active after the oven is switched off. To select a new system, the child lock must first be deactivated.

### OVEN LIGHTING

Oven lighting is switched on automatically when the door is opened or when the oven is switched on.

After the end of the cooking process, the light will remain on for another minute.

The light inside the oven can be switched on or off by pressing the LIGHT key.

## 5sek °C|w **ACOUSTIC SIGNAL**

Loudness of the acoustic signal can be set when no timer function is activated (only the time of day is displayed).

Press the TEMPERATURE/POWER key and hold it for 5 seconds. Two fully lit bars will appear on the display. Rotate the SETTINGS KNOB (-/+ ) to choose one of the three volume levels (one, two, or three bars). After three seconds, the setting will be automatically stored and the time of day will appear.

## 5sek **DECREASING THE DISPLAY CONTRAST**

The cooking system selector knob should be on the "0" position. Press the LIGHT key and hold it for 5 seconds. Two fully lit bars will appear on the display. Rotate the SETTINGS KNOB (-/+ ) to adjust the display dimmer (one, two, or three bars). After three seconds, the setting will be automatically saved.

## + **STANDBY**

Display lighting can be automatically switched off after 10 minutes if it is not used.

Press the KEY + TIMER keys to switch off the display. If a timer function has been activated, then "OFF" and the TIMER icon will appear on the display to indicate the activated function.



**After a power outage or after the appliance is switched off, the additional function settings will remain stored for no more than a few minutes. Then, all settings, except for the acoustic signal and child lock will be reset to factory defaults.**



## STEP 5: STARTING THE COOKING PROCESS

Start the cooking process by pressing the START/STOP key and holding it for a while.



## STEP 6: SWITCHING OFF THE OVEN

Turn the COOKING SYSTEM SELECTOR KNOB to position "0".

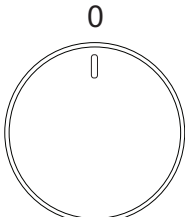

 After the end of the cooking process and after the oven has been switched off, declining temperature is displayed down to 50 °C. All timer settings are also paused and cancelled. Time of day (clock) will be displayed. After one minute of idling, the appliance will switch to standby mode.

 After the use of the oven, some water may be left in the condensate channel (underneath the door). Wipe the channel with a sponge or a cloth.

# DESCRIPTIONS OF SYSTEMS (COOKING MODES) AND COOKING TABLES

---

If your desired food cannot be found in the cooking table, find information for similar food. The information displayed applies to cooking in a single level.

An interval of suggested temperature is indicated. Start with a lower temperature setting and increase it if you find the food is not browned sufficiently.

Cooking times are rough estimates and may vary subject to some conditions.

The symbol \* means that the oven should be preheated using the selected cooking system.

**Only preheat the oven** if required by the recipe or in the tables in this instruction manual. Heating an empty oven consumes a lot of energy. Hence, baking several types of pastry or several pizzas successively will save a lot of energy as the oven will already have been preheated.

Use dark, black silicon-layered or enamel-coated baking sheets and trays as they conduct the heat very well.

When using parchment paper, make sure it is resistant to high temperatures.

When cooking larger chunks of meat or pastry, a lot of steam will be generated inside the oven, which in turn may condense on the oven door. This is a normal phenomenon which will not affect the operation of the appliance. After the cooking process, wipe the door and the door glass dry.

**Switch off the oven approximately** 10 minutes before the end of the cooking process to save energy by making use of the accumulated heat (this does not apply to systems with microwaves).

Do not cool the food in a closed oven to prevent condensation (dew).

## COOKING SYSTEMS

### RAPID PREHEATING



Use this function to heat the oven to the desired temperature as quickly as possible. This mode is not appropriate for cooking.

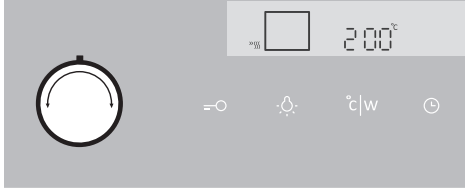

Turn the COOKING SYSTEM SELECTOR KNOB to rapid preheating. PRESET TEMPERATURE will be displayed. This temperature setting can be adjusted.

 When it is switched on, the oven will begin to heat up. The symbol °C will flash on the display. When the set temperature is reached, preheating is completed and an acoustic signal will be sounded. The acoustic signal can be stopped by pressing any key; after one minute, it will stop automatically.

## UPPER AND BOTTOM HEATER

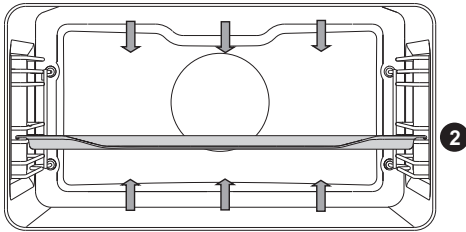

The heaters in the bottom and in the ceiling of the oven cavity will radiate heat evenly into the oven interior.

### Roasting meat:

Use enamel coated, tempered glass, clay, or cast iron pan or tray. Stainless steel trays are not suitable as they strongly reflect the heat.

Use enamel coated, tempered glass, clay, or cast iron pan or tray. Stainless steel trays are not suitable as they strongly reflect the heat.

Type of food	Weight (g)	Guide (from the bottom)	Temperature (°C)	Cooking time (min)
<b>MEAT</b>				
Pork roast	1500	2	180-190	150
Pork shoulder	1500	2	190-200	120-140
Pork roulade	1500	2	190-200	120-140
Meat loaf	1500	2	200-210	60-70
Beef roast	1500	2	180-210	90-120
Roast beef, well done	1000	2	200-210	40-60
Veal roulade	1500	2	180-200	90-120
Lamb sirloin	1500	2	190-200	100-120
Rabbit loin	1500	2	190-200	100-120
Deer shank	1500	2	190-200	70-90
Meat rolls	1500	2	180-200	15-30
<b>FISH</b>				
Braised fish	1000	1	190-210	60-80

## Baking pastry

Only use one level and dark baking sheets or trays. In light-coloured baking sheets or trays, the browning of the pastry will be poorer, as such equipment will reflect the heat. Always place the baking trays on the grid. If you are using the supplied baking sheet, remove the grid. Cooking time will be shorter if the oven is preheated.

Type of food	Guide level (from the bottom)	Temperature (°C)	Cooking time (min)
<b>PASTRY</b>			
White bread*	2	180-190	60
Buckwheat bread*	2	180-190	50
Whole grain bread*	2	180-190	50
Rye bread*	2	180-190	50
Spelt bread*	2	180-190	60
Sweet soufflé	1	170-180	35-45
Soufflé	1	170-180	35-45
Rolls *	2	200-220	30-40
Walnut cake	1	180	55-60
Sponge cake*	2	160-170	20-30
Macarons (meringue pastry)	2	120-140	15-30
Vegetable rolls	2	190-200	15-20
Fruit rolls	2	190-200	25-30
Cheesecake	1	170-180	65-75
Cupcakes	2	160-170	20-30
Small pastries made with yeast dough	2	190-200	20-25
Cabbage pirozhki*	2	180-190	30-40
Fruitcake	2	130	120
Meringue cookies	2	90	120

Tip	Use
<b>Is the cake done?</b>	<ul style="list-style-type: none"> <li>• Pierce the cake at the top with a wooden toothpick or skewer. If there are no traces on the pick or the skewer when pulled out, the cake is done.</li> </ul>
<b>Did the cake collapse?</b>	<ul style="list-style-type: none"> <li>• Check the recipe.</li> <li>• Next time, use less liquid.</li> <li>• Note the mixing time when using small mixers, blenders etc.</li> </ul>
<b>The cake is too light at the bottom?</b>	<ul style="list-style-type: none"> <li>• Use a dark-coloured baking sheet or tray.</li> <li>• Place the baking sheet one guide lower and switch on the lower heater towards the end of the cooking progress.</li> </ul>
<b>Cake with moist stuffing is underdone?</b>	<ul style="list-style-type: none"> <li>• Increase temperature and extend baking time.</li> </ul>



**Do not insert the deep baking tray into the first guide.**



## GRILL

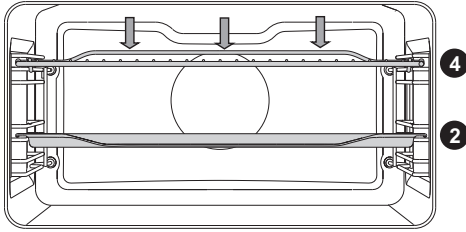

When grilling food, the upper heater and the grill heater fitted on the ceiling of the oven cavity will operate.

Preheat the infrared (grill) heater for five minutes.

Supervise the cooking process at all times. The meat may burn quickly due to high temperature.

Roasting with the grill heater is suitable for crispy and low-fat cooking of bratwurst, cuts of meat and fish (steaks, escalopes, salmon steaks or fillets etc.) or toasted bread.

When grilling directly on the grid, smear it with oil to prevent the meat from sticking onto it and insert it into the 4th guide. Insert the drip tray in to the 1st or 2nd guide. When grilling in a baking tray, make sure there is enough liquid in the tray to prevent burning. Turn the meat during cooking.

After grilling, clean the oven, the accessories, and the utensils.

Type of food	Weight (g)	Guide level (from the bottom)	Temperature (°C)	Cooking time (min)
<b>MEAT</b>				
Beefsteak, rare	180g/piece	4	220-240	14-16
Beefsteak, well done	180g/piece	4	220-240	18-21
Pork neck fillet	180g/piece	4	220-240	19-23
Cutlets/chops	180g/piece	4	220-240	20-24
Veal escalope	180g/piece	4	220-240	19-22
Grill sausages	100g/piece	4	220-240	11-14
Spam (Leberkäse)	200g/piece	4	220-240	9-15
<b>FISH</b>				
Salmon steaks/fillets	600	3	220-240	19-22
<b>TOASTED BREAD</b>				
6 slices of white bread*	/	4	240	1,5-3
4 slices of mixed grain bread*	/	4	240	2-3
Open sandwiches*	/	4	240	3,5-7

When grilling in a baking tray, make sure there is enough liquid in the tray to prevent burning. Turn the meat during cooking.

When baking trout, pat the fish dry with a paper towel. Season on the inside; coat with oil on the outside and place on the grid. Do not turn the fish when grilling.



**Always keep the oven door closed when using the grill (infrared) heater.**

**Grill heater, grid, and other oven accessories get very hot during grilling. Therefore, use oven mitts and meat tongs.**



# GRILL WITH FAN

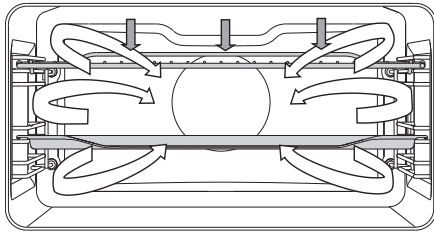

In this operating mode, the grill heater and the fan operate simultaneously. Suitable for grilling meat, fish, and vegetables.

2 (See descriptions and tips for GRILL.)

Type of food	Weight (g)	Guide level (from the bottom)	Temperature (°C)	Cooking time (min)
<b>MEAT</b>				
Duck *	2000	1	150-170	80-100
Pork roast	1500	2	160-170	60-85
Pork shoulder	1500	2	150-160	120-160
Pork shank	1000	2	150-160	120-140
Half of chicken	600	2	180-190	25 (one side) 20 (other side)
Chicken*	100	1	210	60
<b>FISH</b>				
Trout	200g/piece	2	170-180	45-50



## HOT AIR AND BOTTOM HEATER

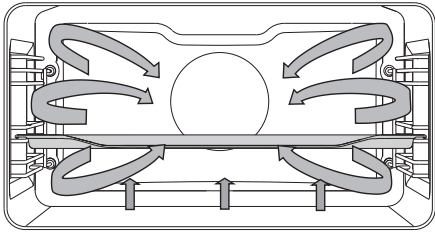

The bottom heater, the round heater, and the hot air fan will operate. Suitable for baking pizzas, apple pies, and fruitcakes.

2 (See descriptions and tips for UPPER and BOTTOM HEATER.)

Type of food	Guide level (from the bottom)	Temperature (°C)	Cooking time (min)
Cheesecake, short crust	2	150-160	65-75
Pizza *	2	200-210	15-20
Quiche Lorraine, shortcrust	2	180-200	35-40
Apple pie, leavened dough	2	150-160	35-40
Apple strudel, phyllo dough	2	170-180	45-65

## HOT AIR

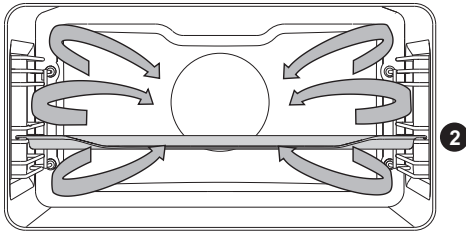

Round heater and the fan will operate. The fan installed in the back wall of the oven cavity makes sure the hot air constantly circulates around the roast or pastry.

### Roasting meat:

Use enamel coated, tempered glass, clay, or cast iron pan or tray. Stainless steel trays are not suitable as they strongly reflect the heat.

Provide enough liquid during the cooking process to prevent the meat from burning. Turn the meat during roasting. The roast will remain juicier if you cover it.

Type of food	Weight (g)	Guide level (from the bottom)	Temperature	Cooking time (min)
<b>MEAT</b>				
Pork roast, including skin	1500	2	170-180	140-160
Pork belly	1500	2	170-180	120-150
Chicken, whole	1200	2	180-190	60-80
Duck	1700	2	160-170	120-150
Chicken breast	1000	2	180-190	60-70
Stuffed chicken	1500	1	170-180	100-120

## Baking pastry

Preheating is recommended.

Biscuits and cookies can be baked in shallow baking sheets on several levels simultaneously (2nd and 3rd).

Note that baking time can differ even with if the baking sheets used are the same. The biscuits in the upper baking sheet may be ready sooner than those in the lower one.

Always place the baking trays on the grid. If you are using the supplied baking sheet, remove the grid.

For even browning, make sure the biscuits are of the same thickness.

Type of food	Guide level (from the bottom)	Temperature (°C)	Cooking time (min)
<b>PASTRY</b>			
Cake	2	150-160	45-60
Sponge cake	2	150-160	25-35
Crumble cake	2	160-170	25-35
Fruit cake, sponge	2	150-160	45-65
Plum cake	2	150-160	35-60
Sponge roll*	2	160-170	15-25
Fruit cake, short crust	2	160-170	50-70
Challah (braided yeast bun)	2	160-170	35-50
Apple strudel	2	170-180	40-60
Jelly-filled rolls (Buchtel)	2	170-180	30-35
Pizza *	2	190-210	25-45
Biscuits, short crust	2	150-160	15-25
Biscuits, pressed	2	150-160	15-28
Cookies, leavened	2	170-180	20-35
Cookies, phyllo dough	2	170-180	20-30
Cream-filled pastry	2	180-190	25-45
<b>PASTRY – FROZEN</b>			
Apple and cottage cheese strudel	2	170-180	50-70
Cheesecake	2	160-170	65-85
Pizza	2	170-180	20-30
Fried potatoes, oven-ready	2	170-180	20-35
Croquettes, oven-baked	2	170-180	20-35
Yoghurt	3	240	40



**Do not insert the deep baking tray into the first guide.**

## PLATE WARMER



Use this function to reheat your dinnerware (plates and cups) before serving food in it to keep the food warm longer.

## ECO COOKING

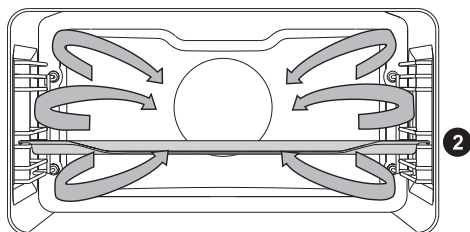

Round heater and the fan will operate. The fan installed in the back wall of the oven cavity makes sure the hot air constantly circulates around the roast or pastry.

Type of food	Guide level (from the bottom)	Temperature (°C)	Cooking time (min)
<b>MEAT</b>			
Pork roast, 1 kg	2	190	150-170
Pork roast, 2 kg	2	190	160-190
Beef roast, 1 kg	2	210	120-140
<b>FISH</b>			
Whole fish, 200 g/piece	2	200	40-50
Fish fillet, 100 g/piece	2	210	25-35
<b>PASTRY</b>			
Pressed cookies*	2	180	25-30
Small cupcakes	2	190	30-35
Sponge roll	2	190	15-25
Fruit cake, short crust	2	190	55-65
<b>VEGETABLES</b>			
Potatoes au gratin	2	190	40-50
Lasagne	2	200	40-50
<b>FROZEN FOOD</b>			
Pommes frites, 1 kg	2	220	25-40
Chicken medallions, 0.7 kg	2	220	25-35
Fish sticks, 0.6 kg	2	220	20-30



Do not insert the deep baking tray into the first guide.

# AUTOMATIC SYSTEMS

## DEFROSTING



The system also includes automatic programs for defrosting the food with microwaves. Food suitable for defrosting includes cakes with heavy cream or butter-based cream, cakes and pastry, bread and rolls, and deep-frozen fruit.

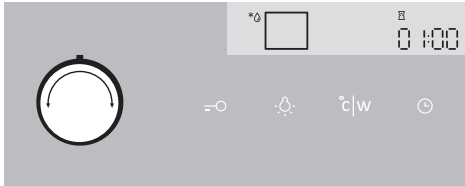

**1** Turn the COOKING SYSTEM SELECTOR KNOB to defrosting. The icon and the program A1 will flash on the display unit (choose between five programs - see table below).

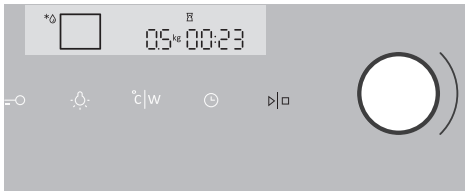

**2** Rotate the SETTINGS KNOB (-/+) and choose the desired program. Press the (°C|W) key to change the weight. Press the START key.

Program	Recipe	Weight (kg)	Cooking time (min)
A1	Meat	1	29:30
A2	Poultry	1	17:00
A3	Fish	1	12:00
A4	Bread	1	12:00
A5	Frozen vegetables	1	16:00

 Defrosting time is calculated based on the default weight of the food.

In most cases, it is recommended to remove the food from the packaging (do not forget to remove any metal clamps or clips). Halfway through the defrost time, the pieces should be turned over, stirred and separated if they were frozen together.

## COMBINED SYSTEMS

### HOT AIR AND MICROWAVES

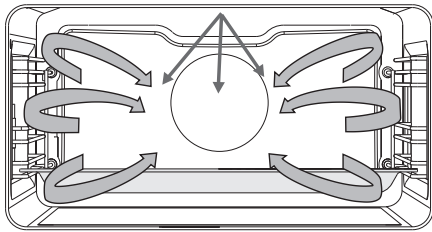

In this cooking mode, the food is cooked with a combination of microwaves and grill.

Power levels: 90, 180, 360, 600 W

- 1 Place the glass baking dish into the 1st guide.

Type of food	Weight (g)	Power (W)	Temperature (°C)	Cooking time (min)
Poultry	1000	360	190-200 °C	30-40
Poultry	polovica	36	190-200 °C	25-35
Chicken - thighs	1000	180	190-200 °C	20-30
Duck	1500	360	190-200 °C	40-50
Poultry - wings	500	600	190-200 °C	15-20



When using this function, do not use metal cookware or utensils.

Do not preheat the oven.



# MICROWAVE SYSTEMS

## MICROWAVES

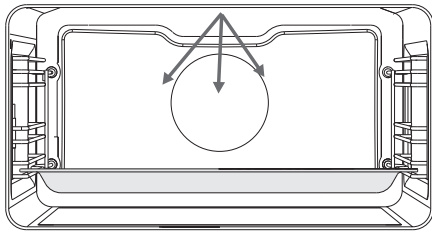

Microwaves are used for cooking and defrosting.

Power levels: 90, 180, 360, 600, 750, 100 W.

1 Place the glass baking dish into the 1st guide.

### Cooking frozen food

Food	Weight (g)	Power (W)	Cooking time (min)
Meat loaf	1000	850	35-40
Chicken	1500	600	52-55
Pork roast	1000	600	50-55

### Cooking fresh vegetables

Type of food	Weight (g)	Power (W)	Cooking time (min)
Eggplant / aubergines	500	1000	5-8
Courgettes	500	1000	5-8
Carrots	500	1000	7-10
Onions	200	1000	2-4
String beans	500	750	10-15
Broccoli	1000	750	15-18
Bell peppers	500	1000	3-5
Cauliflower	1000	750	17-20
Leeks	200	1000	9-12
Brussels sprout	500	1000	9-12
Button mushrooms / Champignons	500	1000	10-14
Asparagus	500	750	5-8
Peas*	500	650	15-20
Cabbage	500	1000	10-14

## Cooking rice and pasta

Type of food	Weight (g)	Power (W)	Cooking time (min)
Rice*	250	1000	14-16
Pasta**	250	1000	11-13
Whole grain pasta*	250	1000	11-13
Oatmeal*	500	1000	7-9
Brown rice***	200	750	31-33
Risotto **	200	750	19-21
Couscous ***	200	1000	2-4
Polenta ***	200	1000	6-8
Millet ***	200	1000	9-11

\*\* Add water in the ratio of 1:2.

\*\*\* Add water in the ratio of 1:3.

## Reheating food and beverages

Type of food	Amount (dl, g)	Power (W)	Cooking time (min)
Water	2 dl	1000	1-2
Coffee	2 dl	1000	1-2
Mulled wine	2 dl	1000	1-2
Milk	2 dl	1000	1-1,5
Side dishes	500 g	600	1,5-2
Sauces	500 g	600	3-5
Soups/stews	5 dl	750	5-7
Popcorn	90 g	1000	5-7
Baby bottle	2dl	350	3-4
Baby food	4 dl	180	2

## Meat

Type of food	Weight (g)	Power (W)	Cooking time (min)
Chicken thighs	500	600	15-20
Chicken wings	500	600	15-20
Meatballs	1000	1000	10-15
Pork chops	500	750	30-35
Chicken braised in sauce	500	1000	8-13
Escalopes/steaks	500	1000	8-12
Chicken-whole	1500	600	50-55
Pork roast	1000	600	50-55
Meat loaf	700	750	35-40

## Deserts

Type of food	Cups	Power (W)	Cooking time (min)
Chocolate soufflé	6	360	7-9
Cheese soufflé	glass baking dish	600-750	15-20
Fruit purée	glass baking dish	750-850	10-15
Custard creams	glass baking dish	600	20

# MAINTENANCE & CLEANING

---



Be sure to unplug the appliance from the power supply and wait for the appliance to cool down.

Children should not clean the appliance or perform maintenance tasks without proper supervision.

## Aluminium finish

Clean the aluminium finish with non-abrasive liquid cleaners intended for such surfaces. Apply the cleaner onto a wet cloth and clean the surface. Then, rinse the surface with water. Do not apply the cleaner directly onto the aluminium finish.

Do not use abrasive cleaners or sponges.

Note: The surface should not come into contact with oven cleaning sprays as this may result in visible and permanent damage.

## Stainless steel sheet front side of the housing

(depending on the model)

Clean this surface only with a mild detergent (soapsuds) and a soft sponge that will not scratch the finish. Do not use abrasive cleaners or cleaners containing solvents as they may damage the housing finish.

## Lacquer-coated surfaces and plastic parts

(depending on the model)

Clean the knobs and door handle with a soft cloth and liquid cleaners intended for smooth lacquer-coated surfaces. You may also use cleaners intended for such surfaces as instructed by the cleaner manufacturer.

## Appliance door

The door is attached to the appliance and may not be removed. Also, the door may not be disassembled or otherwise tapered with.



The aluminium-coated surfaces should not come into contact with oven cleaning sprays as this may result in visible and permanent damage.

# CONVENTIONAL OVEN CLEANING

You may use the standard cleaning procedure to clean stubborn dirt in the oven (using cleaners or an oven spray). After such cleaning, rinse the cleaner residues thoroughly.

Clean the oven and the accessories after each use to prevent the dirt from burning into the surface. The easiest way to remove fat is by using warm soapsuds while the oven is still warm.

With stubborn dirt and grime, use conventional oven cleaners. Rinse the oven thoroughly with clean water to remove all cleaner residue.

Never use aggressive cleaners, abrasive cleaners, abrasive sponges, stain and rust removers etc.

Clean the accessories (baking sheets and trays, grids etc.) with hot water and detergent.

The oven, the oven cavity and the baking trays are lined with a special enamel coating for a smooth and resistant surface. This special coating makes cleaning at room temperature easier.

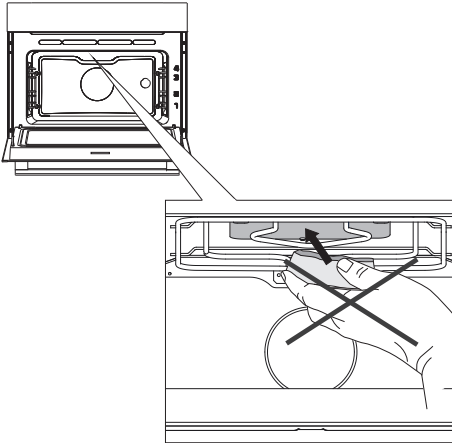

Never use aggressive cleaners, abrasive cleaners, abrasive sponges, stain and rust removers etc. on the oven ceiling cover.

# USING THE AQUA CLEAN FUNCTION TO CLEAN THE OVEN

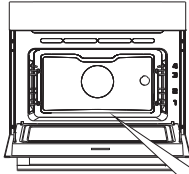

**1** Turn the COOKING SYSTEM SELECTOR KNOB to Aqua Clean. An icon will be displayed along with the PRESET TEMPERATURE and the time of 30 minutes.

 The duration cannot be changed.

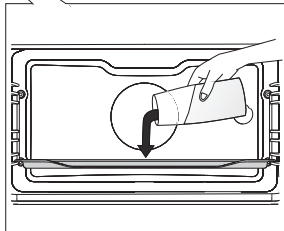

**2** Pour 0.6 l of water into a glass or shallow baking dish and insert it into the lower guide.

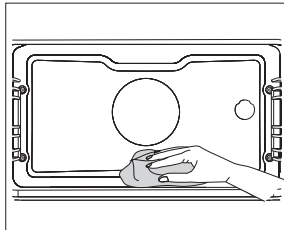

**3** After 30 minutes, food residues on the oven enamel walls will have softened and they will be easy to clean with a damp cloth.



Use the Aqua Clean system when the oven has fully cooled down.

# REMOVING AND CLEANING THE WIRE GUIDES

Only use conventional cleaners to clean the guides.

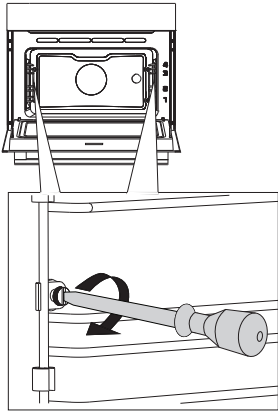

**1** Undo the screw. Use a screwdriver.

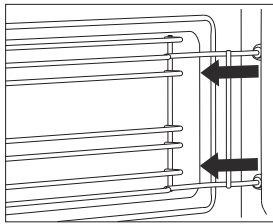

**2** Remove the guides from the holes in the back wall.

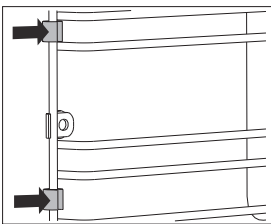

Take care not to lose the spacers fitted on the wire guides. Replace the spacers after cleaning; otherwise, sparks may appear.



**After cleaning, re-tighten the screws on the guides with a screwdriver.**

**When replacing the wire guides, make sure you mount them on the same side they were installed on prior to removal.**

# REPLACING THE BULB

The bulb is a consumable and therefore not covered by warranty. Before changing the bulb, remove the trays, the grid, and the guides.

The oven is fitted with a halogen lamp.

This product contains a light source of energy efficiency class (G).

Use a Phillips (cross) screwdriver.

(Halogen lamp: G9, 230 V, 25 W)

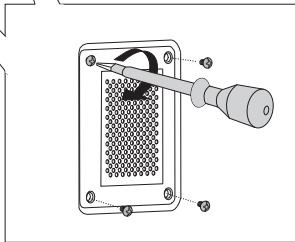
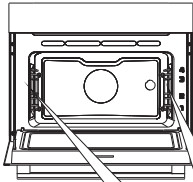

- 1** Undo the four screws on the cover. Remove the cover and the glass.

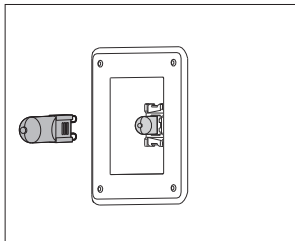

- 2** Remove the halogen light bulb and replace it with a new one.



Use protection to avoid burns.

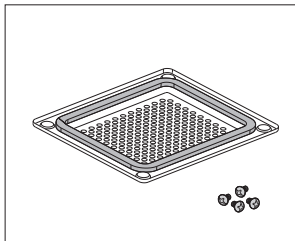

There is a gasket on the cover which should not be removed. Do not allow the gasket to be detached from the cover. The gasket should fit correctly onto the oven cavity wall.



**Firmly re-tighten the screws on the cover using a screwdriver; otherwise, sparks may appear.**



# TROUBLESHOOTING TABLE

Problem/error	Cause
<b>There is no response of the sensors; the display is frozen.</b>	Disconnect the appliance from the power mains for a few minutes (undo the fuse or switch off the main switch); then, reconnect the appliance and switch it on.
<b>The main fuse in your home trips often.</b>	Call a service technician.
<b>The oven lighting does not work.</b>	The process of changing the light bulb is described in the chapter. Cleaning and Maintenance.
<b>The pastry is underdone.</b>	Did you choose the right temperature and heating system? Is the oven door closed?
<b>An error code is displayed (E1, E2, E3 etc.).</b>	There is an error in the electronic module operation. Disconnect the appliance from the power mains for a few minutes. Then, reconnect it and set the time of day. If the error is still indicated, call a service technician.
<b>Sparks appear in the oven.</b>	Make sure all covers of the lights are fastened and that all spacers are fitted on the wire guides. Make sure the guides are correctly placed in the appliance.

If the problems persist despite observing the advice above, call an authorized service technician. Repair or any warranty claim resulting from incorrect connection or use of the appliance shall not be covered by the warranty. In this case, the user will cover the cost of repair.



**Before the repair, disconnect the appliance from the power mains (by removing the fuse or by removing the plug from the wall outlet).**

# DISPOSAL

---



Packaging is made of environmentally friendly materials that can be recycled, disposed of, or destroyed without any hazard to the environment. To this end, packaging materials are labelled appropriately.

The symbol on the product or its packaging indicates that the product should not be treated as normal household waste. The product should be taken to an authorized collection center for waste electric and electronic equipment processing.

Correct disposal of the product will help prevent any negative effects on the environment and health of people which could occur in case of incorrect product removal. For detailed information on removal and processing of the product, please contact the relevant municipal body in charge of waste management, your waste disposal service, or the store where you bought the product.

*We reserve the right to any changes and errors in the instructions for use.*



