

MT IE GB

Instructions for use, installation,
and connection

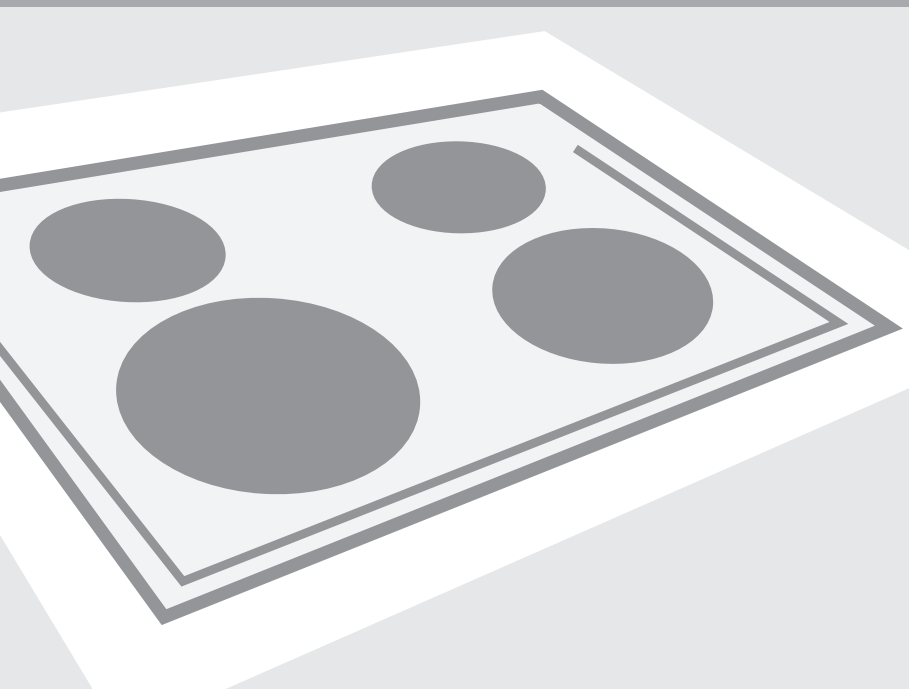

Glass-ceramic built-in coking hob

GLASS-CERAMIC BUILT-IN COOKING HOB

Dear customer!



Glass-ceramic hob is intended for use in households.

Our products are packed in environment-friendly materials which can be recycled, disposed of, or destroyed without imposing any burden on the environment.

Instructions for use

Instructions for use are intended for the user. They describe the appliance and its operation. The instructions apply to various types of appliances and may therefore include description of functions that may not be available on your appliance.

Instructions for connection

The appliance must be connected in compliance with the instructions attached to it, as well as in compliance with relevant regulations and standards. The connection may only be performed by a qualified person.

Rating plate

The rating plate indicating the basic information on the appliance is attached to the lower side of the hob.

Fire risk protection

When the cooking hob is built-in, a kitchen furniture element that is higher than the hob can stand next to in on one side, provided the kitchen element on the other side of the hob is not higher than the hob level.

TABLE

IMPORTANT - READ BEFORE USING THE APPLIANCE	5
Safety precautions.....	5
Warnings.....	5
APPLIANCE DESCRIPTION	7
COOKING ZONES	8
Before using the appliance for the first time.....	8
Important warnings.....	8
Cookware	9
Energy saving.....	9
OPERATING THE COOKING HOB - CONVENTIONAL ZONES	10
Double-ring cooking zone switch.....	11
Control lights.....	11
Warning lights (only with some models).....	11
CLEANING AND MAINTENANCE	12
Cleaning.....	12
INSTALLATION	13
Important warnings.....	13
Installing the foam gasket.....	14
Worktop cutout dimensions.....	14
CONNECTING THE APPLIANCE TO THE POWER MAINS	16
Important warnings.....	16
Connection diagram	17
TECHNICAL CHARACTERISTICS	18
Rating plate.....	18

IMPORTANT - READ BEFORE USING THE APPLIANCE

Safety precautions

- This appliance can be used by children aged from 8 years and above and persons with reduced physical, sensory or mental capabilities or lack of experience and knowledge if they have been given supervision or instruction concerning use of the appliance in a safe way and understand the hazards involved. Children shall not play with the appliance. Cleaning and user maintenance shall not be made by children without supervision.
- **WARNING:** The appliance and its accessible parts become hot during use. Care should be taken to avoid touching heating elements. Children less than 8 years of age shall be kept away unless continuously supervised.
- **WARNING:** Danger of fire: do not store items on the cooking surfaces.
- **WARNING:** Unattended cooking on a hob with fat or oil can be dangerous and may result in fire. Never try to extinguish a fire with water, but switch off the appliance and then cover flame with a lid or a damp cloth.
- After use, switch off the hob element by its control and not rely on the pan detector.
- **WARNING:** If the surface is cracked, switch off the appliance to avoid the possibility of electric shock.
- Do not use steam cleaners or high-pressure cleaners to clean the cooking hob, as this may result in an electric shock.
- The appliance is not intended to be controlled by external timers or special control systems.

Warnings

- The appliance may only be connected to the power mains by an authorized service technician or expert.
- Tampering with the appliance or non-professional repair thereof may result in risk of severe injury or damage to the product. Any repairs may only be carried out by an authorized service technician or expert.

- The appliance is intended solely for cooking. Do not use it for any other purpose, e.g. for room heating. Do not place empty cookware on the cooking zones.
- If another electrical appliance is connected to a AC power socket near the appliance, make sure the power cord does not come into contact with hot cooking zones.
- Do not store temperature-sensitive items underneath the appliance, such as cleaners or detergents, spray cans etc.
- Using the glass ceramic hob as a storage area may result in scratches or other damage to it. Never heat food in aluminium foil or in plastic containers on the cooking hob. Such foil or containers may melt which can result in a fire or damage to the cooking hob.



The symbol on the product or on its packaging indicates that this product may not be treated as household waste. Instead it shall be handed over to the applicable collection point for the recycling of electrical and electronic equipment. By ensuring this product is disposed of correctly, you will help prevent potential negative consequences for the environment and human health, which could otherwise be caused by inappropriate waste handling of this product. For more detailed information about recycling of this product, please contact your local city office, your household waste disposal service or the shop where you purchased the product.

APPLIANCE DESCRIPTION



1 2 3 4 5

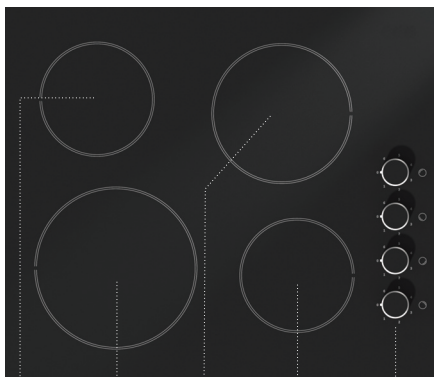

1 2 3 4 5

1. Cooking zone rear left
2. Cooking zone front left
3. Cooking zone front right
4. Cooking zone rear right
5. Cooking hob control unit

COOKING ZONES

Before using the appliance for the first time

Important warnings

Clean the glass-ceramic surface with a damp cloth and some manual dishwashing detergent. Do not use aggressive detergents such as abrasive cleaners that can scratch the surface, abrasive dishwashing sponges, or stain removers.

- Do not turn on a cooking zone without a pan over it, and never use the cooking hob for room heating!
- Make sure the cooking zones and pan bottom are clean and dry, and that sufficient heat transmission is enabled between them, in order to prevent any damage to the heating surface.
- Any fat or oil left on the cooking ones may ignite. Therefore, be careful when using fat and oil to prepare food (e.g. French fries) and control the cooking process at all times.
- Do not place a damp pan or a steam-covered lid on the cooking zones, as moisture is detrimental to them.
- Do not leave a hot pan to cool down on the cooking zones, because moisture will be generated under it, causing corrosion.

Important warnings regarding the glass ceramic hob

- Cooking zone reaches the selected power level or temperature very quickly; however, the area surrounding the cooking zones remains relatively cool.
- The hob is resistant to temperature changes.
- The hob is also impact-resistant. The pans may be placed onto the hob roughly without damaging the hob.
- Glass ceramic hobs should not be used as a worktop. Sharp objects can cause scratches.
- Preparing food in thin aluminum or plastic containers on hot cooking zones is not allowed. Do not place any plastic objects or aluminum foil on the glass ceramic hob.
- Never use a glass-ceramic hob that is cracked or broken. If an object falls on the hob with a sharp edge downwards, this could cause the hob / glass ceramic panel to break. The consequences are visible immediately, or only after a while. If any visible crack should appear, immediately disconnect the appliance from the power supply.
- If sugar is spilt on a hot glass ceramic hob, or a sugar-laden food, immediately wipe the hob.

Cookware

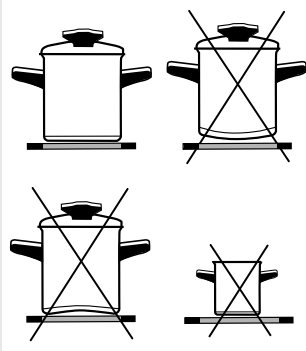

Tips on using the cookware

Use high-quality cookware with a flat and stable bottom.

- Transmission of heat is best when the pan bottom and the cooking zone are of the same diameter, and the pan is placed on the middle of the cooking zone.
- When using a tempered glass (Pyrex) or porcelain cookware, please follow the cookware manufacturer's instructions.
- When using a pressure cooker, do not leave it unattended until the desired pressure is reached. The cooking zone should initially be set to the maximum power level; as the pressure rises, use the sensors to decrease the power level according to the pressure cooker manufacturer's instructions.
- Make sure there is always enough water, either in a pressure cooker or in any other piece of cookware, as using an empty pan on the cooking hob will result in overheating which will damage both the pan and the cooking zone.
- Tempered glass (Pyrex) cookware with a specially brushed bottom is suitable for use on cooking hobs if it fits the diameter of the cooking zone. Cookware with larger diameter may break due to thermal stress.
- When using any special or unconventional cookware, follow the cookware manufacturer's instructions.
- When a highly reflective pan (bright metal surface) or a pan with a thick bottom is used for cooking on a glass-ceramic hob, cooking time can be extended by several minutes (up to 10 minutes). If you wish to boil a larger quantity of food, it is recommended to use a container with a flat dark bottom.
- Do not use clay cookware, because it may leave scratches on the glass-ceramic hob.

Energy saving

- Pan bottom diameters should match the diameter of the cooking zone. If the pan is too small, some heat is wasted; furthermore, using a too small pan can damage the cooking zone.
- Whenever possible given the cooking process, use a lid.
- The pan should be appropriately sized given the quantity of food prepared. Preparing a small quantity of food in a large pan will cause a waste of energy.
- Dishes that take a long time to cook should be prepared in a pressure cooker.
- Various vegetables, potatoes, etc., can be cooked in a small quantity of water; however, the lid should be closed tightly. When the water is brought to boil, reduce the power level to a setting that maintains a temperature just above boiling point.

OPERATING THE COOKING HOB – CONVENTIONAL ZONES

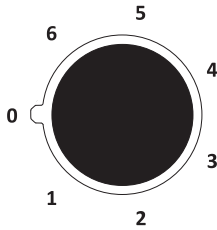
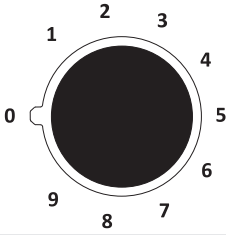

- Turn on the cooking zone using the knobs installed on the control panel.
- The symbol next to each knob indicates which cooking zone is operated by it.
- Cooking zone power level can be set continuously (1-9) or stepwise (1-6).
- The step knobs can be rotated in both directions. With continuous knobs, the power level is increased as you rotate them in the clockwise direction, and reduced as you turn them in the anticlockwise direction.
- The cooking zone may be turned off three to five minutes before the end of cooking in order to make use of the residual heat and save some energy (the following table lists some examples for using individual power levels).

S	E	
0	0	Cooking zone turned off
1	1-2	Maintaining the temperature and reheating of smaller quantities of food
2	3-4	Reheating
3	5-6	Reheating or longer cooking of larger quantities
4	7	Consecutive cooking / frying (e.g. omelets etc.)
5	8	Deep frying
6	9	Quick heating

Double-ring cooking zone switch

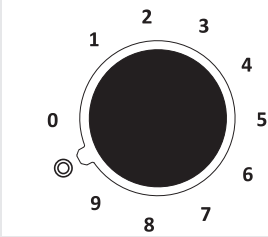

When the double-ring cooking zone control switch is rotated normally, the basic cooking zone (internal) is activated. If you wish to activate the entire cooking zone, rotate the knob to the symbol that follows the number signs, to hear a 'click' sound; then, rotate it back to the desired position. The entire cooking zone is switched off by rotating the knob back to the "0" position.

Control lights

Whenever at least one cooking zone is switched on, a yellow light (LED) is lit up. With some models, this function can be assumed by the backlit dial above the activated knob.

Warning lights (only with some models)

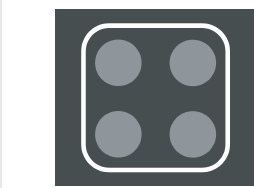

Glass ceramic cooking hobs are fitted with warning control lights in the front part of the panel. If a particular warning control light is lit, it means that the corresponding cooking zone is hot (risk of burning). When the cooking zone is switched off, the warning light remains lit until the cooking zone cools down to under 50°C.

CLEANING AND MAINTENANCE

Cleaning

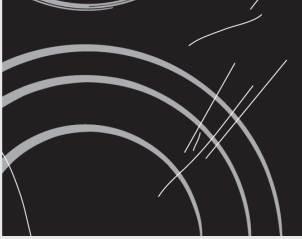

Figure 1

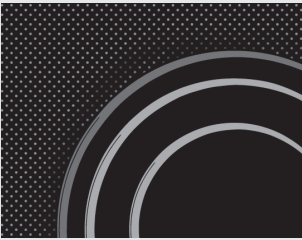

Figure 2



Figure 3



Figure 4

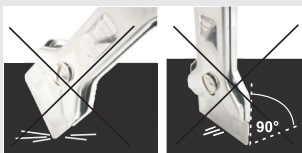

After each use of the **glass-ceramic hob**, wait for it to **cool down** and clean it; otherwise, even the smallest food residue will be burnt onto the hot surface next time you use the appliance. **For regular cleaning and maintenance of the glass-ceramic surface, use special conditioning agents** which form a protective layer on the surface, shielding it from dirt. Before each use, wipe any dust or other particles from the hob surface and pan bottom as these could scratch the surface (Figure 1).

Careful: steel wool, abrasive sponges, and abrasive detergents can scratch the hob surface. Glass ceramic surface can also be damaged by aggressive sprays and inappropriate or insufficiently shaken (mixed) liquid cleaning agents (Figure 1 and Figure 2).

Signage may be worn when using aggressive or abrasive cleaners or cookware with damaged bottom (figure 2).

Light stains can be removed by a damp soft cloth; then, wipe the surface dry (Figure 3).

Water stains can be removed using a mild solution of vinegar; however, do not use this solution to clean the frame (only with some models, as it may become dull. Do not use aggressive sprays or decalcification agents (Figure 3).

Heavier stains can be removed using special agents and utensils for cleaning the glass-ceramic hobs. When using these products, follow the instructions provided by their respective manufacturers.

Make sure any residues of cleaning agents are thoroughly removed, as they could damage the glass-ceramic hob when the cooking zones heat up (Figure 3).

Remove stubborn and burnt residues with a scraper (figure 4).

Be careful when handling the scraper to prevent injury.

! Only use the scraper when dirt cannot be removed with a wet cloth or special cleaners for glass ceramic surfaces.

Hold the scraper at the **correct angle** (45° to 60°). **Gently press the scraper** against the glass and slide it over the signage to remove the dirt. Make sure the plastic handle of the scraper (in some models) does not come into contact with a hot cooking zone.

! Do not press the scraper perpendicularly against the glass and do not scratch the hob surface with its tip or blade.

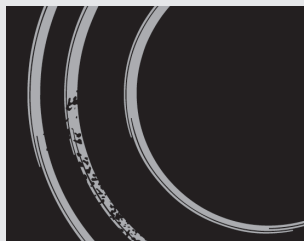

Figure 5

Sugar and sugar-laden food may permanently damage the glass-ceramic surface (Figure 5); therefore, they should be removed from the glass-ceramic surface as soon as possible, although the cooking zone may still be hot (Figure 4).

Clean the glass ceramic hob with a mild non-abrasive cleaner and a soft sponge that will not scratch the surface.

Any change in the color of the glass-ceramic surface does not affect its operation or the stability of the surface. Such discolorations are mostly a result of burnt food residues or use of cookware made of materials such as aluminum or copper; these stains are difficult to remove.

Warning: All damage described above predominantly relates to the aesthetics, i.e. appearance of the appliance and do not affect its functionality directly. Such errors cannot be the subject of a warranty claim.

INSTALLATION

Important warnings

- Installation of the appliance into a kitchen worktop and its connection to the power mains may only be performed by an adequately qualified technician.
- Veneer or other finish of the piece of kitchen furniture into which the hob is to be built in should be treated with heat resistant glue (100°C); otherwise, the worktop finish may be discolored or deformed.
- Cooking hob is dimensioned to be built into the worktop over a piece of kitchen furniture, with a width of 600 mm or more.
- After installation, the front two fastening elements should be freely accessible from below.
- Hanging, or wall-mounted kitchen elements should be installed high enough not to interfere with the work process.
- The distance between the cooking hob and the kitchen hood should be no less than indicated in the instructions for kitchen hood installation. The minimum distance is 650 mm.
- The distance between the appliance edge and the adjacent tall kitchen furniture element should amount to no less than 40 mm.
- Use of massive wood decoration plates or boards on the worktops behind the cooking hob is permitted, if the minimum distance remains the same as indicated in the installation drawings.
- Minimum distance between the built-in cooking hob and the rear wall is indicated on the installation drawing.

Installing the foam gasket

Before inserting the appliance into the opening in the kitchen worktop, the supplied foam gasket must be attached to the lower side of the glass ceramic (glass) cooking hob (see figure above). **Do not install the appliance without the foam gasket!**

The gasket should be attached to the appliance in the following way:

- Remove the protective film from the gasket.
- Then, attach the gasket to the lower side of the glass, approximately 2-3 millimetres from the edge (as shown in the figure). The gasket must be attached along the entire length of the glass edge and should not overlap at the corners.
- When installing the gasket, make sure that the glass does not come into contact with any sharp objects.

NOTE!

On some appliances the gasket is already installed!

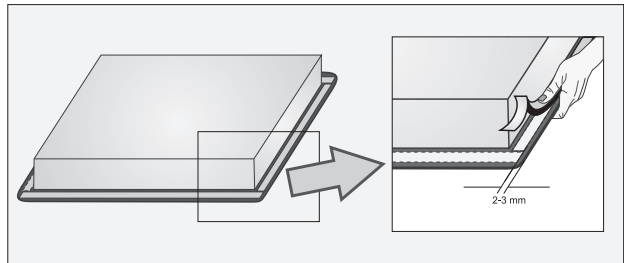

Worktop cutout dimensions

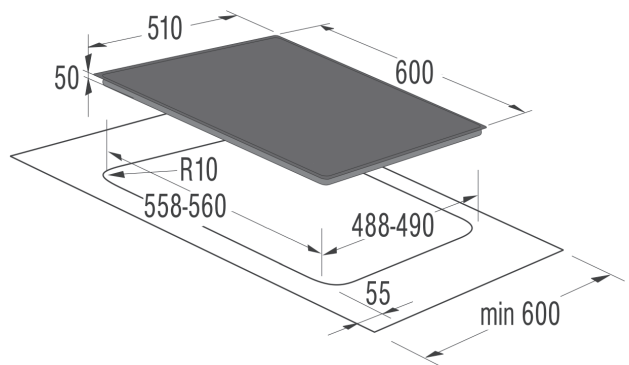

- Cooking hobs can be installed into worktops that are 30 to 50 mm thick.
- The kitchen furniture element underneath the hob should not be fitted with a drawer. If the kitchen furniture element as a horizontal partition wall, it should

be installed no less than 60 millimeters from the lower surface of the worktop. The space between the partition wall and the hob must be empty; no objects should be placed into that gap.

- On the furniture back wall there should be a cutout with width of at least 175 mm along the entire width of the furniture element.
- Only type EVP4...EVP2..., ovens fitted with a cooling fan may be installed underneath this cooking hob.

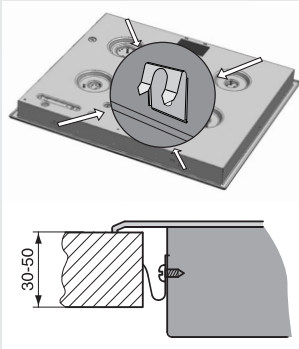

Installation procedure

- The worktop should be installed completely horizontally.
- The cutoff surfaces should be appropriately protected.
- Attach the fastening elements (4x - SVK6...600 mm; 6x - SVK7...750 mm; 6x - SVK8...850 mm) with the supplied screws (4x - SVK6...600 mm; 6x - SVK7...750 mm; 6x - SVK8...850 mm) to the left and right wall of the cooking hob and the worktop cutoff.
- Connect the cooking hob to the power mains (see instructions for connecting a cooking hob on a power network).
- Insert the cooking hob into the cutoff and press it heavily from above against the worktop.
- For screwing down the fixing clip it is not allowed to use screws longer than 6,5 mm.
- Before installing an oven, the rear wall of the kitchen furniture element should be removed in the area of the cooking hob cutout.

CONNECTING THE APPLIANCE TO THE POWER MAINS

Important warnings

- The appliance may only be connected by an authorized skilled technician.
- Electric system protection should comply with all relevant regulations.
- The connection clips can be accessed when the connection clip covers are opened / removed.
- Before connecting the appliance, make sure the voltage indicated on the rating plate is consistent with the voltage in your home circuit.
- The rating plate with basic information is attached on the lower side of the hob.
- The electric circuit should also include an omnipolar switch that will separate the appliance from the mains, if required, with at least 3 mm of distance between contacts. Suitable devices include fuses, current protection switches, etc.
- The connection should be selected according to the installation possibilities with regard to current and fuses.
- Given the protection from the risk of fire, appliances of this type may be installed in a worktop next to a piece of kitchen furniture that is taller than the appliance (when installed); however, in this case, a kitchen furniture not higher than the cooking hob must be installed on the other side, adjacent to the appliance.
- The current conducting and isolated parts must be protected from any possibility of direct contact.

ATTENTION!

- Before any manipulation with the appliance (other than its regular use), disconnect it from the power mains. The appliance should be connected according to the relevant scheme (diagram), subject to the network voltage. Connect the earth (PE) wire to the clip indicated with the earth /ground symbol.
- The mains cord must be fed through the fastening clip / strain release device which protects it from being pulled out accidentally.
- After connecting the appliance, turn on all cookers for approximately three minutes to check their operation.

Connection diagram

- The appliances are suitable for photovoltaic electrical power under the condition that electrical voltage will be 220VAC - 240VAC with semi tonic frequency 50 Hz in order the appliance to operate properly (alternative a generator can be used with the same technical characteristic)."
- Incorrect connection may destroy parts of the appliance, making the warranty void.
- Before connecting the appliance, make sure the voltage indicated on the rating plate is consistent with the voltage in your home network. Connection voltage (230 V through N) should be checked by a qualified technician using a corresponding measuring device!
- Connection cable on the back of the appliance should be led in such way that it does not touch the appliance back wall, as this part will get very hot during operation.

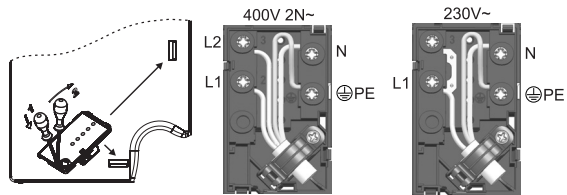

NOTE:

Connection bridges are already installed on their respective places on the clip. Screws of the connection terminals are open, which means they do not have to be unfastened or unscrewed any further. When fastening the screws, you may hear a slight 'click', which means that the screws should be fastened / screwed in completely.

The following can be used for connection:

- Type H05 RR-F 4x1.5 rubber connection cables with a green-yellow protective wire,
- Type H05 VV-F 4x1,5 PCV insulated connection cables with yellow-green protective wire, or other equivalent or superior grade cables.

TECHNICAL CHARACTERISTICS

Rating plate

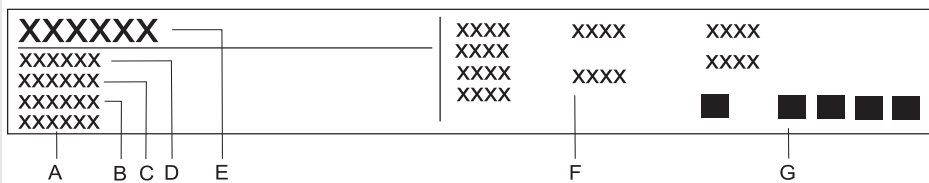

- A Serial number
- B Code
- C Model
- D Type
- E Trademark
- F Technical information
- G Compliance indications / symbols

WE RESERVE THE RIGHT TO MAKE ANY CHANGES THAT DO NOT AFFECT THE FUNCTIONALITY OF THE APPLIANCE.

Instructions for use of the appliance can also be found on our website at www.gorenje.com / < <http://www.gorenje.com> / >



0002-649

EC610SC

SVK65ES



472055

en (07-17)