



Instructions for Use
Руководство по эксплуатации

EN, RU, BY

Dear customer,

You have purchased a product of our new series of appliances. We hope that our product will serve you well and for a long time.

Read this manual before installation and use of this appliance. It contains important information concerning how safely and economically operate the appliance. Save the manual together with the appliance for an eventual further use.

IMPORTANT INFORMATION

Safety measures

- This appliance can be used with children older than 8 years and persons with decreased physical or mental ability or lack of experience and knowledge only in cases, when they are under supervision or when they were introduced to the use of appliance and they understand the possible dangers. The children should not play with this appliance. Cleaning and user maintenance shall not be made with children without supervision.
- **WARNING:** The appliance self and its accessible parts will be hot during the use. You should prevent the contact with heating elements. Do not allow the access for small children.
- **WARNING:** Danger of fire: do not lay down objects on the cooking surfaces.
- **WARNING:** The cooking without supervision with fat or oil on the cooking surface could be dangerous and could cause the ignition of fire. NEVER extinguish the fire here with water, but switch out the appliance first and then cover the flames for instance with pot lid or with a wet cloth.
- **NOTICE:** The cooking process should be provided under supervision. Also a short time cooking should be provided under constant supervision.
- **WARNING:** If the hotplate surface shows cracks, switch out the appliance and the circuit breaker for to prevent an electric shock.
- Use the temperature probe recommended for this oven only.
- **WARNING:** For to prevent the electric shock ensure the switching off of the appliance before replacing the light bulb.
- Do not use rough abrasive cleaning agents or sharp metal scrapes for cleaning of oven door glass, as they could crack the surface and cause the breaking of glass.
- Never use steam or pressure cleaners for cleaning of the appliance. A danger of electric shock is threatening here.

- The appliance is not adapted for control with help of external timers or other special control devices.
- **WARNING:** Stabilizing elements should be mounted for to prevent the overturn of the appliance. See the installation manual.
- **WARNING:** Use the protection of cooking panel designed with the producer of cooking appliance or marked with the appliance producer as suitable in the user's manual only, or protection devices directly built in the appliance. The use of incorrect protection devices could cause accident.

Caution

- Only authorized service worker or similar authorized person can connect the appliance to the electric mains.
- Verify whether the data on the nominal supply voltage, indicated on the type plate, agree with the voltage of your mains.
- The cooker is coupled to mains according to the connection diagram.
- Please let confirm the date of provided installing in the Guarantee sheet.
- Manipulation with the appliance or unprofessional service could lead to risk of serious injury or to damaging of appliance, eventually. The installation, the all repairs, modifications or interventions into the appliance should be provided with an authorized serviceman or similarly authorized person only.
- A device for disconnecting of all poles of the appliance from the mains into the electric wall circuit before the appliance should be inserted, where the contacts distance in disconnected state is 3 mm as minimum (thereafter called in the text as mains switch).
- The product is designed exclusively for cooking. Do not use for other purposes, for instance for room heating. Do not put empty pots on the cooking zones.
- The strangulation of feeding cable in the oven doors could lead to short circuit and damage the appliance. Mind the correct placing of electric feeding cables in a safe distance.
- The electric feeding cables of the appliance or other appliances should not come in contact with the cooking plate or with other hot parts of the cooker.
- Switch off the mains switch before providing cleaning or repairs.
- Do not use the glass-ceramic surface as a shelf. Cracks or other damaging of surface can be caused so. Do not heat up food covered with aluminum foil, plastic pots or similar materials. The danger of melting, fire or the damaging of hotplate threatens in such cases.

- Give your special attention when cooking in the oven. The pans, sheets, gratings and the oven walls could be very hot. Use cooking gloves.
- Never cover the internal oven walls with aluminum foil and do not put down the baking pots directly on the oven bottom. The aluminum foil hinders the air circulation, significantly worsens the baking process and damages the surface layer of internal cover.
- The oven doors could be hot during the baking. Some models have therefor a third glass installed on the doors, which significantly prevents the overheating of external door surface.
- For prevention of overheating the appliance should not be installed behind a decoration door.
- Never store inflammable or explosive objects, objects aggressive to skin (paper, wipers, cleaning agents, plastic bags, detergents, sprays) in the storage shelf of the oven. You prevent so the risk of fire during operation of the appliance. Only the given accessories (pans, drainage pots and similar) can be stored there.
- The oven door hinges could be damaged when overloaded. Do not put heavy objects on the opened doors. Do not lean on the opened doors. Do not sit down nor set foot on the opened oven doors (Mind the children!) Take off the doors before cleaning of the oven.
- The appliance is designed for location directly on the floor. Do not use any base or pedestal.
- The surface of storage shelf could be heated up to a high temperature. At pulling out of hot shelf the surfaces and objects coming into contact or being in a close distance can be damaged. Do not operate the appliance with pulled out shelf. The objects stored in the shelf can be hot; therefor it is not allowed to put flammable or easily flammable objects in this storage shelf.
- It is unallowable to put any combustible matters near the oven cooking plates, oven heaters or in the cooker compartment.
- If the cooker is not in service, see that all of its switches are off.
- We recommend you to turn once every two years to an authorized repair shop in order to check on the cooker function and to make a professional maintenance. Thus you prevent contingent troubles and prolong the cooker service life.
- When detecting a flaw on the appliance compartment, do not repair it by yourself but put the appliance out of operation and ask an authorized person to make the repair.
- The producer bears no responsibility for contingent damages caused by violating the binding instructions and recommendations set forth in these instructions.

- Do not use any accessories whose surface finish is damaged or otherwise defective due to wear or handling.
- Life of the appliance: 10 years.



The symbol on the product or on its packaging determines that this appliance should not be given into the domestic waste. It should be delivered to collection spot for recycling of electric and electronic devices. With correct liquidation of this product you can help at prevention of negative consequences for the environment and for the human health, which could be else caused with improper liquidation of this product. More detailed information on recycling of this product you can receive at competent local authority, service for liquidation of domestic waste or in the shop, where you had bought the product.

THE PURPOSE OF THE APPLIANCE

The appliance is designed for usual preparation of food in households and it should not be used for other purposes. The individual possibilities of its use are fully described in this manual.

ATTENTION!

If the glass ceramic surface should brake or crack, do not use it. Disconnect the appliance and call Service immediately.

CONTROL PANEL

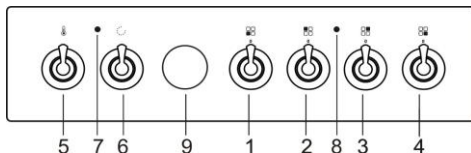

1. Left front hot plate control knob
2. Left rear hot plate control knob
3. Right rear hot plate control knob
4. Right front hot plate control knob
5. Temperature selector
6. Oven function knob
7. Thermostat function signal lamp
8. Power on indicator
9. Electronic timer

BEFORE FIRST USE

- Before using the appliance for the first time, remove the protective and packing material from the cooker.
- Various parts and components of the cooker and package are recyclable. Handle them in compliance with the valid regulations and national legislation.
- We recommend the cleaning of cooker and accessories before first use.
- After drying of cleaned surfaces switch on the main switch and observe the instructions below. It is not allowed clean and dismount parts which are not mentioned in the paragraph concerning cleaning.

OVEN

Turn the control knob to the top and bottom heater position before first use of the oven. Set the temperature selector to 250°C and leave the oven in operation with the door shut for 1 hour. Provide proper room ventilation. This process will remove any agents and odors remaining in the oven from the factory treatment.

COOKING WITH THE APPLIANCE

NOTICE

- Solely adults may operate the appliance in accordance with these instructions. It is not allowed to leave small children without supervision in a room where the appliance is installed.
- Children should be supervised to ensure that they do not play with the appliance.
- An electro cooker is an appliance whose operation requires supervision.
- The baking plate in grooves can be loaded up to 3 kg as maximum. The gridiron with a pan or baking plate can be loaded up to 7 kg as maximum.
- The baking plates and pans are not designed for a long-term storage of foodstuffs (longer than 48

hours). For longer storage, store the food in a convenient dish.

THE GLASS CERAMICS COOKING PLATE WITH COOKING ZONES

The cooking zones of a standard cooker have 9 level capacity levels regulations. The highest capacity is at regulation level "9", the smallest one on the level "1".

We can use the electric cooking zones for cooking, roasting and similar; we recommend the use of pots with even bottom for these purposes.

The overheating of zone under the glass ceramics plate is prevented with help of a temperature limiter. The signal light of residual heat in the front part of glass ceramics plate is signaling the increased temperature of cooking zone surface, even when the heating element is switched off already.

The energy of hot cooking zone can be used for other purposes. This signal light switches off after cooling down of cooking zone, when no burning danger exists more here.

The so called "Hi-light" and the double cooking zones have a stepless control of capacity.

GLASS CERAMIC HOB - DUOZONE ☺

The middle part of cooking zone with diameter Ø 120 mm is controlled with turning of the button for regulation of energy to the right. The capacity can be adjusted smoothly from 0 to 700 W.

At turning of button to the right up to ☺ maximal capacity the cooking zone with Ø 180 mm diameter is switched on. The cooking zone is then working on maximal capacity 1700 W according to selected level 1 (min.) up to 9 (max.). The both parts of the zone will be switched off at turning the button to its zero position.

The overheating of zone under the glass ceramics plate is prevented with help of a temperature limiter. The signal light of residual heat in the front part of glass ceramics plate is signaling the increased temperature of cooking zone surface, even when the heating element is switched off already.

The energy of hot cooking zone can be used for other purposes. This signal light switches off after cooling down of cooking zone, when no burning danger exists more here.

BASIC RULES FOR USING OF GLASS CERAMIC HOBS

- Do not switch on the cooking zone before putting a pot on it and never use the hotplate for heating up the room.
- Whatever fat or oil on the cooking zones could ignite. Therefore be careful at using of such materials during food preparation (e.g. chips) and always watch the whole cooking process.
- Use pots with even bottom only; the bottom surface should be without impressed impurities, which could cause scratches.
- The grains of sand could cause scratches, which could not be removed. Put pots with clean bottom on the cooking surface only. Lift the pot before changing its position on the hotplate.
- Do not use pots from clay (crocker); they could scratch the surface of hotplate.

- Do not use the glass-ceramic surface as a shelf. Cracks or other damaging of surface can be caused so. Do not heat up food covered with aluminum foil, plastic pots or similar materials. The danger of melting, fire or the damaging of hotplate threatens in such cases.
- Do not allow the overrunning of pots. The hotplate is protected against overheating, but a pot with overflow content could be heated so much that it could damage the plate. Such damage is not covered with the warranty.
- Never use vessels with deformed bottom. A convex or concave bottom can have impact the overheating protection and the appliance could be excessively hot. This could cause the rupture of glass-ceramic plate and the damaging of the bottom.
- The glass-ceramic plate is very solid but it is not unbreakable. The plate can break when an object falls with its edge on the plate. Such damage comes out immediately or after a while. Disconnect the damaged hotplate from the main immediately and do not use it.
- Never put on the cooking zones pots with humid bottom or lids with condensed water. The cooking zones could be damaged with it.
- Never let cool down the utensils directly on the cooking zone. Moisture could be created under the vessel and this can cause of its corrosion.
- At cleaning remove the rests of food from the cooking surface first and this immediately during the cooking and provide the final cleaning after finishing of cooking. Special care should be devoted to removing of sugary burnt-on rests; they can at long impact affect the structure of glass-ceramic plate.
- Make you sure that all rests after cleaning agents are completely removed after cleaning, as they could damage the glass-ceramic plate after heating up of cooking zones.
- Metal shining stains appear after using of aluminum vessels or after use of unsuitable cleaning agent; the stains can be removed after repeated cleaning only.
- The scratches of glass-ceramic plate can be caused for instance with grains of sand caught on vegetables, with the rests of unsuitable cleaning powder or of a cleaning agent containing abrasive particles.
- Wipe off gently with humid clout the plate contaminated with earth, sand or similar abrasive agents and then clean it with a liquid cleaning agent designed for glass-ceramic surfaces.
- Never use steel wool, washing sponge or other cleaning matters with rough surface. We do not recommend also the agents supporting corrosion, as for instance sprays for cleaning of roasters and for removing of stains.
- During cooking the borders of vessels should not come in contact with or put on the frame of the glass-ceramic plate.



OVEN INSIDE

Oven is fitted with three level side guides for inserting the grid.

A top and bottom heating elements are inside of the oven. An air distributor and oven fan are situated in the rear of the oven.

OVEN OPERATION

The oven function mode is selected with the oven function knob. The knob can be turned in both directions.

Operation temperature is set with the temperature selector, ranging from 50 - 250°C. Clockwise rotation of the selector sets higher temperature, and vice versa, anticlockwise turning reduces the temperature.

Forcible overturning of the zero position will lead to the thermostat damage!

WARNING!

Do not cover oven bottom with aluminum foil, do not place directly on the bottom an oven tray, baking pan, container, food or food products. Such coverage causes local overheating of the bottom surface of the bottom of the furnace and the furnace can be irreparably damaged.

INSERTING OF GRID IN THE OVEN

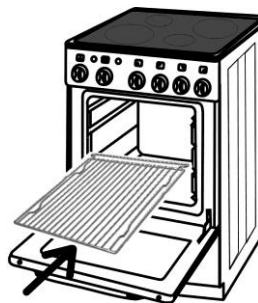

OVEN FUNCTIONS AND THEIR USE

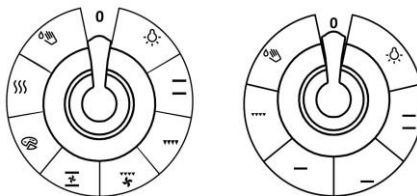

The oven illumination can work at all oven functions.

The producer is not responsible for defects of glass-ceramic plate caused with unsuitable type of used vessels or for defects caused with unsuitable or inappropriate manipulation.



Static oven heating with the top and bottom heaters.

The thermostat can be set to a temperature within 50-250°C.



Bottom heater in operation. The temperature selector can be set anywhere between 50-250°C.

Tip: This function is used for baking which requires high temperature from below.



Top heater in operation. The temperature selector can be set anywhere 50-250°C.

Tip: This function is used for baking which requires high temperature from above (crusting).



Grilling by infrared radiation. The temperature selector is set to the maximum position.



Grilling assisted with oven fan.

Temperature inside the oven is higher towards the top. The temperature selector is set between the 150-250°C range.

Tip: This function is also used for grilling or baking bulky meat chunks at high temperature. Oven door is closed.



Grilling assisted with oven fan.

Temperature inside the oven is higher towards the top. The temperature selector is set between the 50-250°C range.

Tip: This function is also used for grilling or baking bulky meat chunks at high temperature. Oven door is closed.



»PIZZA SYSTEM«

This new cooking mode is ideal for making pizza. Pizza is baked in a preheated oven at a temperature of approx. 190-210°C. Baking tray with pizza is placed in bottom guide level for 15 – 20 minutes, depending on the size of pizza. Noticed baking time is for information only (depends on sort of pizza).



Warming zone – keep warm of done dish
(baking grid is in second level)

Use this function to heat ready made food. Set the temperature to 70°C and place the food onto the support grid inserted in the second guide level.

Reheating time is a matter of your choice, but make sure it is not too short, or the food will not be thoroughly reheated.



Applying lower heater/ Aqua Clean

Heat is applied only by the bottom side of the oven. Use this option for browning the bottom side of the food (baking heavy, moist pastry with fruit dressing). The temperature selection button in such cases may be selected as required. Lower heater may also be used for the cleaning of oven. You will find details in the section Cleaning and maintenance.

BAKING AND ROASTING CHART

Below are some recommended temperatures for the preparation of typical food for your help.

50-70°C Drying
130-150°C Stewing
150-170°C Preservation
180-220°C Baking of risen dough
220-250°C Meat roasting

It is necessary to try out a precise temperature value for every sort of food and baking or roasting method. Before putting the food in, it is necessary to preheat the oven in some cases.

If the selected temperature is not reached, the thermostat signal light is on. If the selected temperature is exceeded, the thermostat signal light goes out.

The best results are with inserted gridiron, on which a baking plate or pan is laid down, into the second groove from below on sides of the oven.

If possible, do not open the oven door during the process of baking. The thermal regime of an oven will thus be disturbed, the baking time prolonged and the food can be burnt.

FOOD GRILLING

Grilling with the oven door shut.

The position of grid depends on the mass and the type food.

As a general rule the grid should be placed in top level guide.

ATTENTION

When using a grill, the accessible parts (oven door, etc.) may become very hot, so make sure that children are well away at a safe distance from the oven.

GRILLING MEAT ON A GRID

Put the prepared food on a grid.

Slide the grid into the side guides in such way that loose portion of the grid (with fewer cross bars) is turned towards you.

Slide a shallow baking pan filled with water one level below the grid to catch the dripping gravy from the grid.

ELECTRONIC PROGRAM TIMER

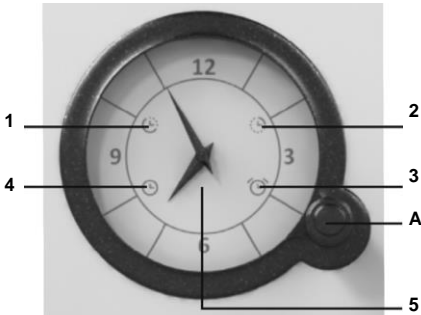

A Function selection knob

- 1 Oven delayed start
- 2 End oven operation
- 3 Minute minder
- 4 Time display
- 5 Clock

- Select the time settings by consecutively pressing the (A) knob. Selected symbol will flash on the display. Rotate the (A) knob to set the function and press to confirm. Clock hands will automatically move to time display. The set symbols will remain lit.
- Each time you press the (A) knob, this will be confirmed by a short acoustic signal.
- Press and hold the (A) knob for 2 seconds to delete the set function.

SETTING THE TIME OF DAY

- If the time display symbol (4) is flashing (after connecting the appliance for the first time or following a power failure), press the (A) knob and hold it for two seconds until the flashing stops.
- Then select the time display (4) by consecutively pressing the (A) knob. Time display will flash when selected.
- Rotate the (A) knob to set the time.
- Confirm the setting by pressing the (A) knob again. If nothing is pressed, the setting will be stored automatically after a few seconds.

OVEN OPERATION WITHOUT TIMER SETTINGS

- After connecting the appliance to the power mains for the first time or after a power supply failure, time display symbol (4) will flash.
- In order for the oven to operate, press the (A) knob and hold it for two seconds. Time display will stop flashing.
- The oven can be used without restrictions if no timer settings are made.

OVEN OPERATION WITH PROGRAM TIMER SETTINGS

Program timer can be used to program oven operation in two ways:

- **Setting the stop time** - the oven will stop operating at the preset time.
- **Setting delayed start** - the oven will automatically start and stop operating at a preset time.

SETTING THE STOP TIME

This mode allows you to set the time at which you wish the oven to stop operating. The longest possible setting is 15 hours from the current time.

- Check if the clock is set accurately to current time.
- Select the (2) symbol by consecutively pressing the (A) knob until the symbol starts to flash.
- Rotate the (A) knob to set stop time.
- Confirm the setting by pressing the (A) knob again. Clock hands will move to time display. The oven stop symbol will light up.
- Switch on the oven (use the oven knobs to set the operating mode and temperature). The oven will start operate at the set time and stop and the selected stop time.
- When the clock reaches the selected stop time, the oven will be switched off, which will also be indicated by an intermittent acoustic signal. The acoustic signal can be switched off by pressing the (A) knob; otherwise, it will switch off automatically after 1 minute. The symbol (2) will flash. To continue cooking, press the (A) knob and hold it for 2 seconds, and set a new cooking time if necessary.

SETTING THE DELAYED START

This mode allows you to specify the time when the oven should start to operate (cooking start time) and the time when you wish the cooking process to stop (end time). Stop time may be delayed by a maximum of 12 hours relative to the current time of day; cooking duration may be set to a maximum of 3 hours.

- Check if the clock is set accurately to current time.
- Setting the start time: Select the (1) symbol by pressing the (A) knob. Rotate the (A) knob to set the start time and confirm it by pressing the (A) knob. The symbol for the end of operation will start to flash (2).
- Set the stop time: Rotate the (A) knob to set the stop time and confirm it by pressing the (A) knob.
- The clock hands will turn to clock display. Symbols (1) and (2) will be lit up.
- The timer will wait for the start of the cooking process.
- Set the oven – use the oven knobs to set the operating mode and temperature.
- The oven will start to operate at the start time, and stop operating at the stop time.
- When the clock reaches the selected stop time, the oven will be switched off, which will also be indicated by an intermittent acoustic signal. The

acoustic signal can be switched off by pressing the (A) knob; otherwise, it will switch off automatically after 1 minute. The symbol (2) will flash. To continue cooking, press the (A) knob and hold it for 2 seconds, and set a new cooking time if necessary.

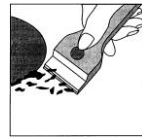

SETTING THE MINUTE MINDER

The clock can also be used as a minute minder which will sound an alarm upon expiry of a set amount of time. The minute minder can only be selected when the program timer is not programmed or in use.

- Select the (3) symbol by consecutively pressing the (A) knob until the symbol starts to flash.
- Rotate the (A) knob to set the time when you wish the minute minder to sound the alarm. The longest possible setting is 3 hours.
- Confirm the setting by pressing the (A) knob again. Clock hands will automatically turn to lock display and the symbol (3) will be lit up.
- When the time you set runs out, an intermittent acoustic signal will be sounded. The acoustic signal can be switched off by pressing the (A) knob and holding it for 2 seconds; otherwise, it will switch off automatically after 1 minute.

DISPLAYING THE SETTING

Whenever a timer function is set, you may check it by pressing the (A) knob. The clock hands will briefly move to the set value and then return to display the current time.

DELETING A SETTING

Delete the setting by pressing the (A) knob and holding it for 2 seconds. The symbol of the deleted function will be switched off.

MAINTENANCE AND CLEANING OF THE COOKER

Keep to the following principles while cleaning or maintaining the cooker:

- Set all knobs in off position.
- The mains circuit - breaker placed before the appliance must be in OFF position.
- Wait until the cooker is cool.

LACQUER-COATED AND PLASTIC SURFACES

Clean the buttons / knobs and the door handle with a soft cloth and liquid detergents intended for cleaning smooth lacquer-coated surfaces. You may also use the cleaners made especially for this type of surfaces; in this case, follow the manufacturer's instructions.

WARNING

The above surfaces should never come into contact with oven cleaning sprays, as these will permanently damage the aluminum parts.

COOKING PLATE

Clean the cold hob after each use. Rest impurities could be singed during next cooking.

Never use abrasive means scratching the hob. For cleaning use only special detergents for glass ceramic hobs (for instance Vitroclean).

Do not use abrasive detergents, spring matters or sponge with rough side. These things can scratch the glass ceramic hob. For cleaning use only special detergents specified for cleaning of glass ceramic hobs.

LIGHT IMPURITIES

Use damp sponge and after cleaning dry up the surface. Water stains caused by boiling over can be removed by lemon juice or vinegar.

HARD IMPURITIES

Remove them with help of concentrated cleaning detergent which should be spread on the hob. Remove singed pieces by a scraper and let detergent working for a few minutes. Than clean carefully the surface with cold water and dry out. The cleaning detergent could be aggressive during the next operation.

SUGAR IMPURITIES (JAM, JELLY...)

Remove immediately with a scraper in hot stage already. In other case permanent traces can appear. Clean with usual method after cooling down.

METAL GLISTENING SPOTS

They can appear when using aluminum utensils or inappropriate cleaning detergent. Removing such a spots is possible with repeating of cleaning process. **Color stains** on the hob surface are usually caused with not removed singed impurities. These stains have no influence to the function of the glass ceramic hob.

RUB DOWN OF DECOR

This can be caused with abrasive cleaners or long time grazing of a pan on the hob. Dark stains can appear on the hob.

NOTICE

Remove rest of meals from hob during cooking and final cleaning make when finish cooking. Sugar stains (jam, jelly,..) remove immediately by scraper. In other case permanent traces can appear.

OVEN

Clean the oven walls with a damp sponge with detergent. If there are baked rests on the wall, use a special detergent for enamel. Carefully dry up the oven after cleaning.

Clean the oven only when cold. Never use abrasive means scratching the enameled surface.

Wash the oven appurtenances with a sponge and detergent or employ a washing-up machine (gridiron, pan, etc.) or use suitable detergent to remove the rough impurities or burns as the case may be.

AQUA CLEAN

The oven may be cleaned in a traditional mode (using ovencleaners and sprays). The following procedure is recommended for regular cleaning of the oven (after each use): Turn the mode selection button to the position . Set the temperature control button of the cold oven to 50°C. Pour 0,4 l of water into the baking pan and insert it into the bottom gridlead. After thirty minutes the food residues upon the enamel coating are softened, and may be easily wiped off with a moist cloth.

CHANGE OF THE OVEN LAMP

- Set all the control knobs to "off" and disconnect the cooker from the mains
- Unscrew the lamp glass cover in the oven by turning left
- Unscrew the faulty bulb
- Put and screw a new bulb in
- Mount the bulb glass cover.

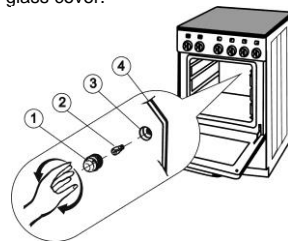

NOTE

For illumination it is necessary to use a bulb of type T 300°C, E14, 230 - 240 V, 25 W.

1. Glass cover
2. Lamp
3. Sleeve
4. Oven rear wall

OVEN

Procedure for cleaning of internal glass door.

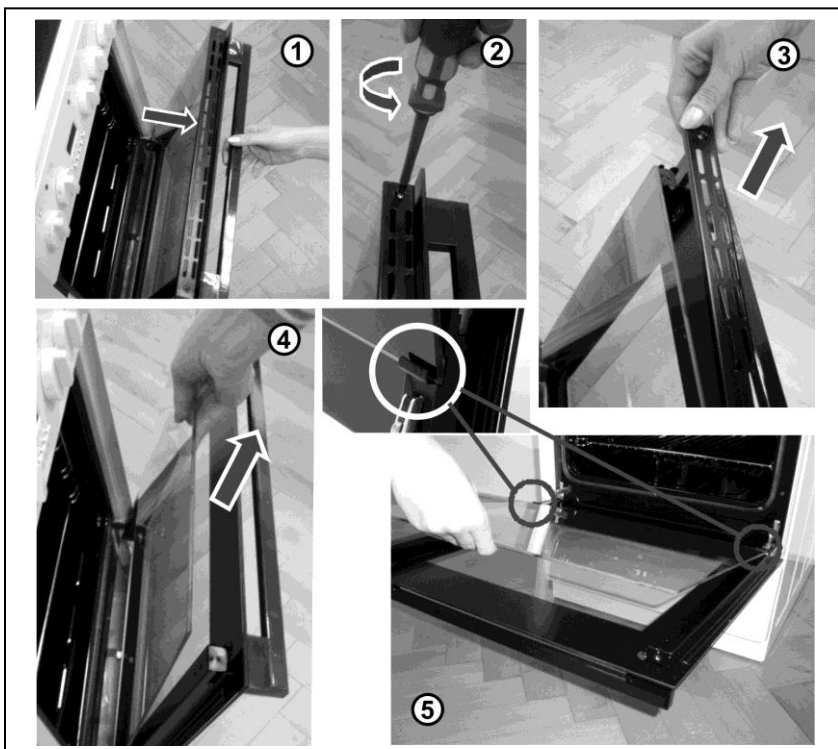

CLAIMS

In case of any defects of the appliance during warranty period, do not attempt to repair it by yourself. Make a claim at an authorized dealer or at place of purchase and ensure that you are in possession of the Certificate of warranty. Beware that in the absence of duly completed Certificate of warranty your claim is null and void.

NOTE

The appliance will be delivered to you with the appropriate protective wrapping. This packaging material is valuable and can be recycled if such facilities are available in your locality.

METHODS OF UTILISATION AND LIQUIDATION OF PACKAGES

The collection of packages at collecting places in your locality guarantees their recycling.

Corrugated board, wrapping paper

- sale to the collecting places

- in garbage containers for collection paper

Wooden parts

- other utilization

- to with the municipality destined place for refuse dumping

Wrapping foil and bags

- in garbage containers for plastic parts

LIQUIDATION OF AN APPLIANCE FOLLOWING ITS LIFE EXPIRATION



The appliance comprises valuable materials, which ought to be newly utilized. Dispose the appliance on the collecting place or on with the municipality destined place for refuse dumping.

This appliance is marked in accordance with the Directive 2012/19/EU on waste electrical and electronic equipment - WEEE.

After expire of life time give the appliance to the collecting place for used electric and electronic equipment.

INSTALLATION INSTRUCTIONS AND SETTINGS

CONNECTION OF THE COOKER TO THE ELECTRIC MAINS

A device disconnecting the appliance from mains, whose off contacts of all poles are in a minimum distance of 3 mm, must be built in the stable electrical energy distribution before the appliance.

There is the recommended three-phase connection of the cooker with the aid of an H05RR-1.5 type connecting cord (previously CGLG 5Cx1.5) whose ends are to be adjusted to figure 4.

It is necessary to brace the conductor ends with pressed terminals against fraying.

For single-phase connection use an H05RR-F3G-4 (previously GGLG3Cx4) type connecting cord and brace the conductor ends to figure 5.

After bracing the conductor ends beneath the terminal board screw heads place a cord in the terminal board and secure it by a clip against tearing (figure 5). Eventually close the terminal board cover.

Solely an authorised, skilled person may install the cooker. The authorised person is obliged to set the cooker cooking plate in horizontal position, to connect it to the mains and to check up on its duty. Installation of the cooker must be confirmed in the certificate of warranty. The electric cooker is a heat consumer, the installation and location of which must correspond with local standards in force.

For the cooker connection we advise using a connecting cable:

- Cu 3 x 4 mm² as minimum - for single-phase connection (circuit breaker 35 – 38 A to the type)

- Cu 5 x 1.5 mm² as minimum - for three-phase connection (circuit breaker 3x16A)

IMPORTANT NOTICE

At any electric cooker disassembly or assembly besides its current use it is necessary to disconnect the appliance from mains and to keep it out of service.

In installation of the appliance, it is necessary to do in the light of its duty chiefly the following:

- Verification of the correctness of mains connection,
- A check on the duty of heaters, control and governing elements,
- Presentation to the client of all functions of the appliance and familiarisation with its service and maintenance.

NOTICE

The electric cooker is a Class I appliance according to the electric current injury prevention degree and must be interconnected with the mains protective conductor.

LOCATION

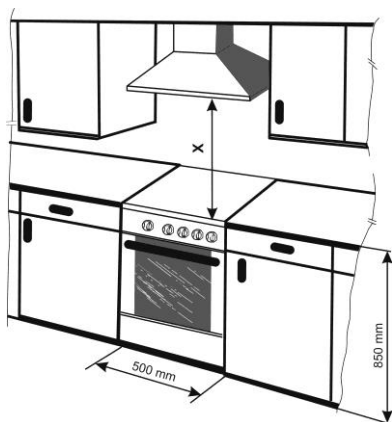

Solely company authorized to provide such activities may perform the installation of this hotplate and it should be installed in compliance with local standards and regulations.

This appliance is intended for installation into a normal internal environment (for instance kitchen, dwelling space, etc.).

This appliance can be not installed in a bath room and similar rooms with higher humidity.

It can be mounted in a kitchen line without side gap (the minimal space in the furniture is 500 mm).

To the appliance close walls and furniture (floor, kitchen rear wall, side walls) should be resistant against temperatures up to 100°C or a suitable thermal insulation should be used.

The distance between the cooking plate and the kitchen hood should be minimally 650 mm („X“), or according to recommendation of the hood producer.

The appliance is designed for location directly on the floor. Do not use any base or pedestal.

LEVELING THE APPLIANCE

Cooker hob must be leveled in horizontal position by means of 4 leveling screws supplied with the appliance.

- Remove the cooker receptacle;
 - Tilt the cooker on one side;
 - Screw plastic screws into the bottom crossbar front and rear openings on one side;
 - Tilt the cooker on the opposite side and fix the screws into the openings on the other side;
 - Level the cooker using a screwdriver from the receptacle area, or by turning the leveling screw with a hexagon wrench;
- The procedure is less complicated if performed by using leveling screws.

NOTE

Leveling screws are unnecessary if the appliance height and horizontal position are acceptable.

WARNING

In order to prevent tipping of the appliance, this stabilizing means must be installed.

INSTALLATION

The stabilizing agent against overturning appliances - console - is as shown attached to the wall using dowels and screws. Subsequently, the appliance is placed against the wall so that the attached bracket is inserted into the hole in the rear wall.

INSTALLATION PROCEDURE

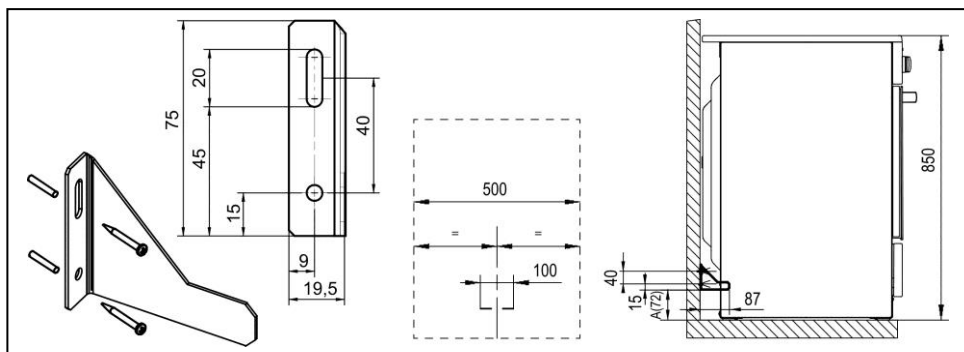

- Set the cooker to the designated place, or align with adjustability.
- Pull out the cooker and measure the distance "A" from the floor.
- Screw the wall bracket as shown (one screw into the center of the slot).
- Push the cooker into place and verify the functionality of the console (or height-adjustable bracket).
- Pull out the cooker and attach the second bracket screw.
- Slide the cooker into place.



NOTE

The producer reserves the right of minor modifications in the instructions resulting from innovations or technological changes of the product.

TECHNICAL DATA			
ELECTRIC COOKER	EC55CLB1	EC55CL11	EC52CL11
Dimensions			
Height / Depth / Weight (mm)	850 / 500 / 605		
Oven			
Left rear (kW)	1,20	1,20	1,20
Left front (kW) – Ø 180 / 120 mm	1,70 / 0,70	1,70 / 0,70	1,70 / 0,70
Right rear (kW)	1,80	1,80	1,80
Right front (kW)	1,20	1,20	1,20
Top heating (kW)			
Top heating (kW)	0,75	0,75	0,75
Bottom heating element (kW)			
Bottom heating element (kW)	1,10	1,10	1,10
Grill heater (kW)			
Grill heater (kW)	1,85	1,85	1,85
Circular heater (kW)			
Circular heater (kW)	-	-	-
Oven fan (W)			
Oven fan (W)	30 - 40	30 - 40	-
Oven light (W)			
Oven light (W)	25		
Min. / max temperature oven			
Min. / max temperature oven	50 / 250°C		
Nominal power supply voltage			
Nominal power supply voltage	230 / 400 V ~		
Total power of the appliance (kW)			
Total power of the appliance (kW)	7,90	7,90	7,8

INFORMATION TABLE			
MODEL	EC55CLB1	EC55CL11	EC52CL11
A – More efficient B C D E F G – Less efficient	A	A	A
Energy consumption (kWh) 	0,79	0,79	0,94
Time to cook standard load	53,1	53,1	56,7
Energy consumption (kWh)  / 	0,79	0,79	
Time to cook standard load	47	47	
Usable volume (litres)	48	48	51
Usable volume:			
SMALL			
MEDIUM	←	←	←
LARGE			
Noise (dB)	46	46	
Min. energy consumption (standby) (W)	0,9	0,9	0,9
The area of the largest baking sheet	1230		

ACCESSORIES	EC55CLB1	EC55CLI1	EC52CLI1*
Grid	+	+	+
Fat pan	+	+	
Backing tray	+	+	+
Scraper	+	+	+
Adjustable feet	+	+	+
Console	+	+	+

* Cookers are equipped with new secure door hinges COMFORT. These special hinges guarantee very quiet and gentle closing of the oven door.

<p>SERIAL NUMBER X XX X XXXX X.....Year of production XX.....Week of the year X.....Purpose of usage of appliance XXXX.....Sequence of product in the week</p>

Lifetime – 10 years
Does not contain harmful substances - RoHS
Earthing sign 

MORA MORAVIA, s.r.o., Hlubočky– Mariánské Údolí, Czech republic

SAP 457196en

L=65 mm, BLACK, ЧЕРНЫЙ, ЧОРНИЙ, ҚАРА - L3
 L=45 mm, BLACK, ЧЕРНЫЙ, ЧОРНИЙ, ҚАРА - L2
 L=45 mm, LIGHT BLUE, СВЕТЛО-СИНИЙ, СВІТЛО СИНИЙ - N
 АШЫҚ КӨК - N
 L=50 mm, GREEN AND YELLOW, ЗЕЛЕНО-ЖЕЛТТЫЙ – PE (⊕)
 L=25 mm, BROWN, КОРИЧНЕВЫЙ, КОРІЧНЕВИЙ, ҚОҢЫР L1

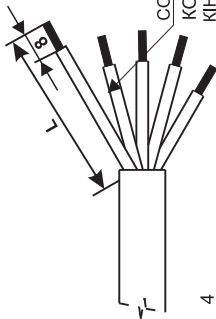

L=45 mm, BROWN, КОРИЧНЕВЫЙ - L
 КОРИЧНЕВЫЙ, ҚОҢЫР - L
 L=45 mm, LIGHT BLUE, СВЕТЛО-СИНИЙ - N
 СВІТЛО СИНИЙ, АШЫҚ КӨК - N
 L=50 mm, GREEN AND YELLOW, ЗЕЛЕНО-ЖЕЛТТЫЙ – PE (⊕)
 ЗЕЛЕНО-ЖОВТИЙ, САРЫ-ЖАСЫЛ – PE (⊕)

CONDUCTOR ENDS BRACED WITH PRESSED TERMINAL
 КІНЦІ ПРОВІДНИКІВ ЗАПРЕСОВАНИМ
 КІНЦІ ПРОВІДНИКІВ УКРІПЛЕНО НАПРЕСОВАНИМ КІНЦІКАМИ
 ҚЫСЫЛҒАН СОҢЫМЕН БЕКІТІЛГЕН СЫМДАРДЫҢ СОҢДАРЫ

4

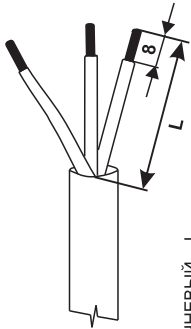

1/1/PE 230V ~
 1 2 3
 L₁ 0 0 0
 4 5
 N 0 0
 PE 0 0

3/N/PE 400V ~
 1 2 3
 L₁ L₂ L₃ 0 0 0
 4 5
 N 0 0
 PE 0 0

КОНЦАНИЕМ

6

SINGLE-PHASE CONNECTION / ОДНОФАЗОВОЕ ПОДКЛЮЧЕНИЕ ОДНОФАЗОВЕ ПІДКЛЮЧЕННЯ/БІР ФАЗАЛЫҚ ҚОСЫЛЫМ

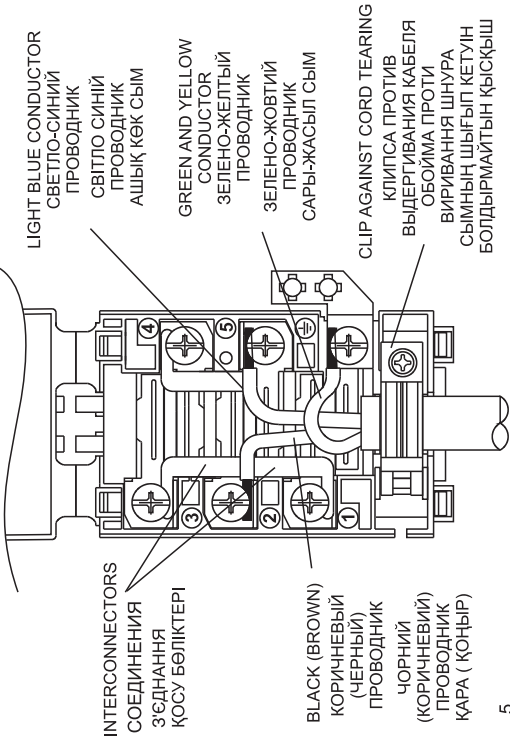

INTERCONNECTORS
 СӨЗДІНАНІЯ
 СЕДНАНІЯ
 ҚОСУ БӨЛКІТЕРІ

BLACK (BROWN)
 КОРИЧНЕВЫЙ
 (ЧЕРНЫЙ)
 ПРОВІДНИК
 ЧОРНИЙ
 (КОРИЧНЕВИЙ)
 ПРОВІДНИК
 ҚАРА (ҚОҢЫР)

LIGHT BLUE CONDUCTOR
 СВЕТЛО-СИНИЙ
 ПРОВІДНИК
 СВІТЛО СИНИЙ
 ПРОВІДНИК
 АШЫҚ КӨК СЫМ
 GREEN AND YELLOW
 CONDUCTOR
 ЗЕЛЕНО-ЖЕЛТТЫЙ
 ПРОВІДНИК
 ЗЕЛЕНО-ЖОВТИЙ
 ПРОВІДНИК
 САРЫ-ЖАСЫЛ СЫМ

SLIP AGAINST CORD TEARING
 КІМТІСА ПРОТИВ
 ВЫДЕРТИВАНИЯ КАБЕЛЯ
 ОБОЙМА ПРОТИ
 ВИРІВАННЯ ШНУРА
 СЫМНЫҢ ШЫҒЫП КЕТУІН
 БОЛДЫРМАЙТЫН ҚЫСҚЫШ

5

THREE-PHASE CONNECTION / ТРЕХФАЗОВОЕ ПОДКЛЮЧЕНИЕ ТРИФАЗОВЕ ПІДКЛЮЧЕННЯ/ҮШ ФАЗАЛЫҚ ҚОСЫЛЫМ

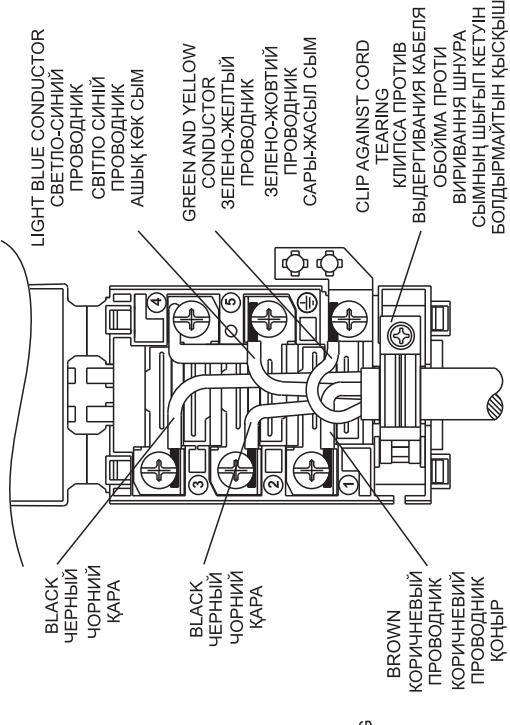

BLACK
 ЧЕРНЫЙ
 ЧОРНИЙ
 ҚАРА

BLACK
 ЧЕРНЫЙ
 ЧОРНИЙ
 ҚАРА

BROWN
 КОРИЧНЕВЫЙ
 ПРОВІДНИК
 КОРІЧНЕВИЙ
 ПРОВІДНИК
 ҚОҢЫР

LIGHT BLUE CONDUCTOR
 СВЕТЛО-СИНИЙ
 ПРОВІДНИК
 СВІТЛО СИНИЙ
 ПРОВІДНИК
 АШЫҚ КӨК СЫМ
 GREEN AND YELLOW
 CONDUCTOR
 ЗЕЛЕНО-ЖЕЛТТЫЙ
 ПРОВІДНИК
 ЗЕЛЕНО-ЖОВТИЙ
 ПРОВІДНИК
 САРЫ-ЖАСЫЛ СЫМ
 SLIP AGAINST CORD
 TEARING
 КІМТІСА ПРОТИВ
 ВЫДЕРТИВАНИЯ КАБЕЛЯ
 ОБОЙМА ПРОТИ
 ВИРІВАННЯ ШНУРА
 СЫМНЫҢ ШЫҒЫП КЕТУІН
 БОЛДЫРМАЙТЫН ҚЫСҚЫШ

SLIP AGAINST CORD
 TEARING
 КІМТІСА ПРОТИВ
 ВЫДЕРТИВАНИЯ КАБЕЛЯ
 ОБОЙМА ПРОТИ
 ВИРІВАННЯ ШНУРА
 СЫМНЫҢ ШЫҒЫП КЕТУІН
 БОЛДЫРМАЙТЫН ҚЫСҚЫШ

www.gorenje.com



Cooking with passion.

EAC

ТОВАР СЕРТИФИЦИРОВАН