

EN Instructions for use, mounting and connection

PL Instrukcja obsługi, wbudowania i podłączenia

RO Instrucțiuni de utilizare, montare și conectare



Integrated gas hob

Gazowa płyta grzejna do zabudowy

**Cuptorul integrat cu funcționare pe
baza de gaz**



Dear Buyer,

This integrated gas hob is manufactured for household use. Our appliances are packed in the environmentally friendly materials which may be recycled, deposited or destroyed without any hazard to the environment. Such packaging materials are also labeled accordingly.

Once the life cycle your appliance is over, make sure not to pollute the environment, and deliver it to the authorized collectors of old household appliances.

Instructions for use

Instructions for use have been prepared for the user, and describe the appliance and the way it is handled. These instructions are intended for various types of the appliance, so you may find some descriptions for the functions that your particular appliance may not have.

Instructions for connecting the appliance

Check before the installation, whether the local condition for the fuel distribution (kind and pressure of gas) are equal with setting up of the appliance.

This appliance is not connected to device for fume exhaustion; the appliance have to be installed and connected according to valid mounting rules; special attention should be paid to corresponding requirements for venting of the room. The connections must be carried out in accordance with the instructions supplied with the appliance, and in compliance with the recognized standards.

Connections must be performed by qualified personnel only.

Rating plate

The setting up of this appliance is given on the product sheet. Rating plate with the basic information is fixed to the bottom side of the hob.

Safety precautions

- Only certified specialist can build in the appliance into a furniture set, connect it to gas distribution net and to the electric power net.
- During the operation of gas burners the room may be filled with extra heat and humidity, so it is necessary to assure adequate ventilation. Occasional opening of the window or door should provide enough exchange of air. During the prolonged use of the appliance, or during a very intense use, more ventilation will be required, and it will probably be necessary to engage the extractor hood.
- Never use the burners if the flame of the outlet gas is unstable.
- In case you should smell gas in the room, immediately shut the main gas supply valve at the gas tank or the gas installation, extinguish all open fires (including the cigarette), and abundantly ventilate the room. Do not switch any electrical devices on, and call the qualified gas personnel at once!
- The main gas supply valve must be shut also in case you do not intend to use the gas burners for any considerable amount of time (i.e. leaving for a vacation).
- Particular cooktop areas (especially the hotplates) may become very hot during operation. Do not let small children in the vicinity of the cooker and warn them about the danger of burns.
- Hot grease is highly inflammable, so pay extra attention when preparing food with grease or oil. Frying in fat or oil (chips) may be carried out only under constant surveillance.
- Hotplates may not operate empty, without dishes placed on top.
- Never use the appliance for heating of the room.
- In case of any detected malfunction immediately disconnect the appliance from the mains supply and call the service.
- The appliance is manufactured in compliance with the relevant effective safety standards. Nevertheless, we strongly recommend that persons with impaired physical, motoric, or mental capacity, or persons with inadequate experience or knowledge, do not use the appliance unless attended by a qualified person. The same recommendation applies when the appliance is used by persons of less-than-legal age.
- This appliance can be used with children older than 8 years and persons with decreased physical or mental ability or lack of experience and knowledge only in cases, when they are under supervision or when they were introduced to the use of appliance and they understand the possible dangers. The children should not play with this appliance. The user cleaning and maintenance can be not provided with children without inspection.



The symbol on the product or on its packaging indicates that this product may not be treated as household waste. Instead it shall be handed over to the applicable collection point for the recycling of electrical and electronic equipment. By ensuring this product is disposed of correctly, you will help prevent potential negative consequences for the environment and human health, which could otherwise be caused by inappropriate waste handling of this product. For more detailed information about recycling of this product, please contact your local city office, your household waste disposal service or the shop where you purchased the product.

Special warning for glass ceramic hob

- Glass ceramic hob is tough, but not unbreakable. Should any sharp or heavy objects fall upon the surface, they may cause damage.
- If you notice any cracks on the ceramic glass surface, stop using the hob immediately because there is danger of electric shock! Switch all burners off and disconnect the hob from the mains by unplugging the mains lead or switch off the fuse. Call service assistance.
- Sand particles or rough wrought iron pot bottoms may also produce scratches upon the glass ceramic surface.
- In case the glass ceramic hob is used as a worktop it may be damaged or scratched. Never heat up the food in aluminum foil or plastic dishes, otherwise you may damage the hob or cause melting of material and fire.

NOTICE!

In case of glass braking of the cooking unit:

- Immediately close the input of fuel into the burners and disconnect the electric heating elements and the appliance from the power net.
- Do not touch the surface of appliance.
- Do not use the appliance.

Description of the appliance

Hob surface is made of ceramic glass and is fitted with gas burners and control buttons (depending upon the model).

1. Rear burner – large (B)
2. Front burner – small (A1)
3. Double burner (Wok)
4. Front burner control button
5. Rear burner control button
6. Control button of the double burner
7. Cast iron cooking grating

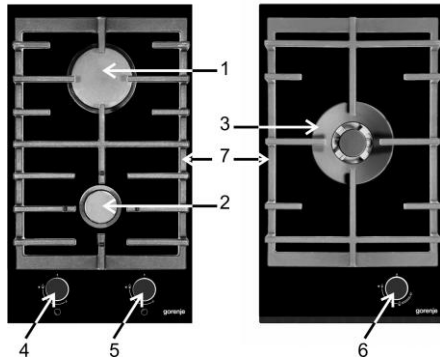

Control buttons

Twin burner model

| | | |
|--|--|-------------------|
| | | Gas faucet closed |
| | | High power |
| | | Low power |

Single – Double burner (WOK)

| | | |
|--|--|---|
| | | Gas faucet closed |
| | | High power - inner burner circle |
| | | Low power - inner burner circle |
| | | High power - inner, intermediate and exterior burner circle |
| | | Low power - inner, intermediate and exterior burner circle |

The location of grating

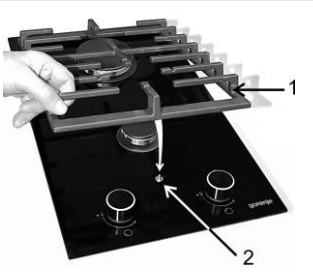

1. Cast iron cooking grating.
2. Centering – setting pin of the grating.



- The cast iron cooking grating is heated up during appliance operation and remains hot during some time even after extinction of the gas burners. Therefore be always careful (also at manipulation with the control knobs), for to prevent burning!
- The cooking grating at the burner can be loaded with an utensil of total weight of 15 kg.
- Put the utensils on the cooking grating without impact!

Gas burner control

Safety cautions in regard to the cooking zones

- Never use cooking zones without dishes, or for heating the ambience!
- Keep the cooktop clean, since dirt and stains have adversary effect on the functionality of burners.
- If you like your food to be crisp, first set the burner to the maximum and continue cooking at minimum power.
- Always provide adequate quantity of water when cooking in the pressure cooker. Lack of water may cause damage to the dish and to the cooker.
- Be very precise when placing the burner crown cap upon the crown. Always keep the crown nozzles clean and free.
- In certain models hob burners are thermally protected. If the flame is accidentally extinguished (spilled boiling, draft of wind, etc.) gas inlet is automatically shut, and gas can not escape into the room.
- In case of thermally non-protected burners, gas uncontrollably escapes into the room without warning!

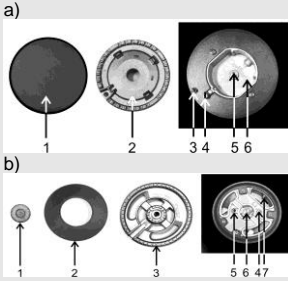

Ignition and operation of burners

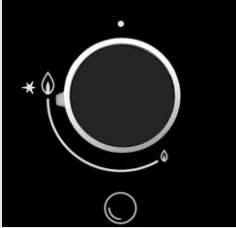



Large and auxiliary burner

- a) 1. Burner crown cap
 2. Burner crown with burner cap support
 3. Thermal probe (thermally protected burners only, only certain models)
 4. Ignition plug
 5. Nozzle
 6. Bowl of the burner





Double burner (wok) - certain models only

- b) 1. Burner cup WOK
 2. Burner crown cap
 3. Burner crown with burner cap support
 4. Thermal probe (thermally protected burners only, only certain models)
 5. Ignition plug
 6. Nozzle
 7. Nozzle

Twin burner model:

- Cooking burners are controlled with relevant burner buttons. These are marked with small flame and large flame symbols (see section 'Description of the appliance').
- Always turn buttons over the large flame symbol  towards the small flame symbol  and back. Operating positions are all positions between the two symbols.
- Burners are ignited by means of ignition device, fixed adjacent to each burner (certain models only).

Models with one double burner (WOK):



- Cooking burners are controlled with relevant burner buttons. These are marked with small flame and large flame symbols (see section 'Description of the appliance').
- Turn the knob to the left over the large flame position for the interior burner section  to the small flame of the interior burner section . Here the knob needs to be pushed in order to turn it to the large flame position of the interior, intermediate and exterior burner section  and further to the position of small flame for the interior, intermediate and exterior burner section  then turn it back. Working position is between the large and the small flame symbol.

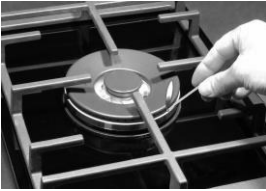

Always push the button in before starting to turn it!



| Burner type | Dish diameter |
|--|---------------|
| Large (3kW) | 220 - 260mm |
| Auxiliary (1 kW) | 120 - 180mm |
| Double (WOK) – interior flame (1kW) | 120 - 180mm |
| Double (WOK) – all flame | 220 - 280mm |

- To ignite the burner, press the selected burner button and turn it to the maximum power position (large flame symbol). Electric spark from the ignition device ignites the gas.
- If the ignition device is out of order (power failure or humidity), use a match or a lighter to ignite the gas. Keep the button pressed for approximately 10 seconds after ignition to stabilize the flame.
- After that you can set the burning power between high and low position to suit your cooking requirements. Button positions between ,  and  are not recommended. In these positions the flame is not stabilized and may be extinguished.



If you failed to ignite the burner after 15 seconds, shut the burner off and wait for at least one minute before the next attempt.



If the burner flame goes out (for whatever reason), shut the burner off and wait for at least one minute before next attempt.

- To shut the burner off turn the button to the right, to the OFF position.

Cookware

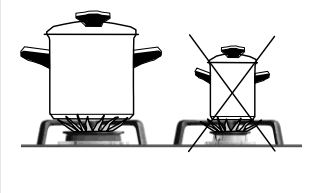

- Selection of the adequate dish size ensures optimized cooking time and consumption of gas. Diameter of the dish is of utmost importance.
- The flame reaching over the edge of the small diameter dish may destroy the dish, while the consumption of gas is increased.
- Gas needs oxygen for burning. In case of excessively large dish diameter the oxygen supply is insufficient, consequently reducing the burning capacity.

Grating for small pots

The grating for small pots can be bought afterwards
– order number SAP 428741

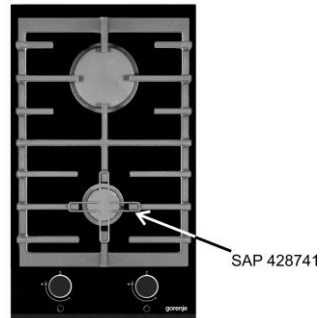
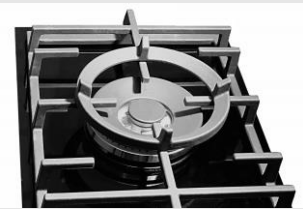

Wok accessory (for the double burner (Wok))

- Use the extension when preparing food in a Wok.
- Place the extension over the burner grid support.

Cleaning and maintenance

The appliance should be cleaned with warm water, liquid detergent and soft cloth. Never use aggressive cleaners and sharp objects. Burned or dried food particles should be moistened with a wet cloth and softened with an appropriate cleansing agent.

Stainless steel surfaces must be cleaned with special cleaners for stainless steel. Apply a fine layer of the cleaner with a dry, well absorbing cloth to the dried and cool surface, and rub in

the direction of the surface treatment. Stubborn stains should be removed with wet cloth and then rubbed dry with a dry cloth to the brilliance. Never use such cleaners for cleaning of aluminum.

Clean plastic and coated surfaces with liquid non-abrasive cleaning agents using soft cloth.

Cooktop burners

- Gas grid, cooking area and burner components should be cleaned with warm water and mild detergent for manual washing of dishes.
- Thermal element and ignition device should be cleaned with soft brush. To ensure perfect operation, these elements must always be thoroughly clean.
- Clean the burner crown and cap. Specially check and clean gas outlet openings on burner crown, and keep them dirt free at all times.
- Upon completion of cleaning wipe all components dry and replace them carefully to their respective slots. Oblique position of components may cause troubled ignition of burners.

Note! Crown caps are coated with black enamel. Discoloration of caps, due to high temperatures, is inevitable, but it has no adversary effect on normal operation of burners.

Cleaning and maintenance of ceramic-glass hob

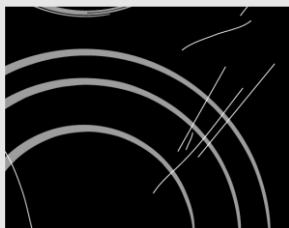

fig. 1

Ceramic glass hob should be cleaned only when completely cooled down, preferably after each use, otherwise even the slightest stains remaining after cooking may burn into the hob surface with each following use.

For regular maintenance of ceramic-glass hob use special cleansing agents, produced in such way to create protective film upon the surface.

Before each use, wipe the dust and other particles from the hob - they may scratch the surface (Fig. 1).

Caution: use of steel wool, abrasive cleaning sponges, and abrasive detergents can scratch the surface of the hob. The surface may also be damaged by the use of aggressive sprays and inappropriate liquid chemicals (Fig.1 and 2).



fig. 2



fig. 3



fig. 4

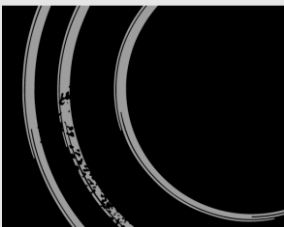

fig. 5

Pattern marks can be erased by the use of aggressive cleansing agents or rough and damaged cookware bottoms (Fig. 2).

Minor stains are removed with moist soft cloth; after that the surface should be wiped dry (Fig. 3).

Water stains are removed with gentle vinegar solution, but you must not wipe the frame with it (certain models only), since it may lose its glow. Never use any aggressive sprays or limestone removers (Fig. 3).

Major stains are removed with special ceramic-glass cleansers. Follow strictly the manufacturer's instructions.

Be careful to remove any remains of cleansing agent from the hob surface, otherwise they will be heated during the next use and can damage the hob (fig. 3).

Stubborn and burnt stains are removed with special ceramic-glass scraper. Be careful, however, not to touch the hotplate surface with the scraper handle (Fig. 4).

Handle the scraper with utmost care to avoid injuries!

Sugar and sugar containing food may permanently damage the ceramic-glass hob surface (Fig.5), so the remains of sugar and sugar containing food must be scraped off from the hob surface immediately, when the hotplates are still hot (Fig. 4).

Discoloring of ceramic-glass hob has no effect whatsoever on its operation and stability. In most cases, it appears as the consequence of burnt in food remains, or as a result of dragging pots and pans (especially aluminum or copper bottom cookware) across the surface, and such discoloring is rather hard to remove.

Note: All described faults are mostly esthetical and do not affect directly the operation of the appliance. Remedy of such faults is not covered by warranty.

Troubleshooting guide

Repairs may be done by qualified personnel only. Any unskilled attempt to repair the appliance is extremely dangerous.

Before attempting any repairs disconnect the appliance from the mains by removing the fuse or unplugging the mains lead from the mains socket.

Any unskilled attempts and/or repairs may cause electric shock and short circuit. To avoid such injuries any repairs may be performed only by qualified personnel or after sales service.

Note: There are, however, some minor faults which may be easily removed by the user, in accordance with the instructions that follow.

Important

If the malfunction of the appliance was caused by the improper use, the service visit during the warranty period is not free of charge.

Keep these instructions always on hand and if you sell the appliance hand them over to the new user.

Following are some simple advice how to repair minor faults:

| Fault | Cause | Remedy |
|---|--|--|
| Burner flame is not steady. | Wrong setting of gas. | Expert should set the gas escape properly! |
| Burner flame suddenly changes. | Incorrect assembly of burner components. | Assemble the burner components correctly! |
| Ignition of burners takes excessively long. | Incorrect assembly of burner components. | Assemble the burner components correctly! |
| The flame goes off after ignition. | Early release of control button. Control button is not pushed in firmly. | Keep the button pressed longer. Before releasing the button, give it one final solid push. |
| The color of the cooking zone gas grid has changed. | Normal situation, caused by the high temperature. | Clean the grid with metal cleaning agents. |
| Electric operations are generally disturbed. | Fuse is burned. | Check the fuse in the fuse box, and replace if required. |
| Electric ignition of burners does not function. | Food residues or detergent block the contact between the ignition device and the burner. | Open and clean carefully the opening between the ignition device and the burner. |
| Burner crown caps look ugly. | Usual staining. | Clean the crown cap with metal cleaning agents. |

Installation instructions

Caution!

- To avoid any possible hazard, the appliance may be installed by qualified personnel only.
- The veneer or the cover of furniture, respectively, in which the appliance is built in, has to be prepared from materials with thermal endurance up to 100° C as minimum, for preventing the changing of color and shape because of insufficient thermal endurance.
- The cooking hob is intended for building into the worktop above the kitchen element of 600 mm width or more.
- Suspended kitchen elements above the cooktop must be installed at such distance to provide enough room for comfortable working process.
- The distance between the worktop and the hood must be at least such as indicated in the instructions for installation of the kitchen hood, but in no case it may be less than 650 mm.
- Minimum distance between the appliance edge and adjacent high element is 150 mm.
- The use of hard wood decorative borders around the worktop behind the appliance is allowed, in case the minimum distance remains as indicated on the installation illustrations.
- Minimum distance between the built-in cooktop and rear wall is indicated at the illustration for the installation of the built-in cooktop.

Dimensions of the built-in hob opening

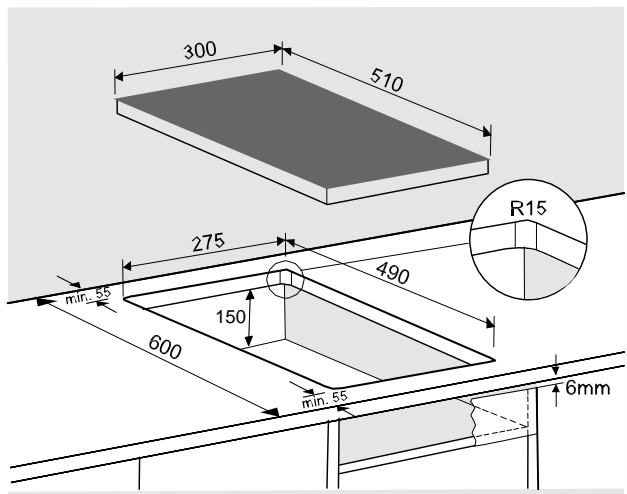

- The appliance may be installed in any worktop with a thickness from 30 mm to 50 mm.
- Bottom kitchen element must not have a drawer. It must be fitted with a horizontal plate 150 mm away from the worktop bottom surface. Space between the plate and the hob must be empty and no objects may be stored or kept there.
- Rear side of the kitchen element must also have a 150 mm high opening along the entire width of the element, and the front part must have an opening of no less than 6 mm.
- Only ovens with cooling fan can be inserted below gas cooking hob. Prior inserting the oven, it is necessary to remove the rear kitchen element panel in the area of the oven opening. Equally, the front part of the element must have an opening of no less than 6 mm.

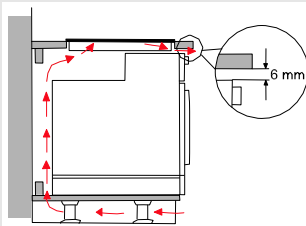

Installation procedure

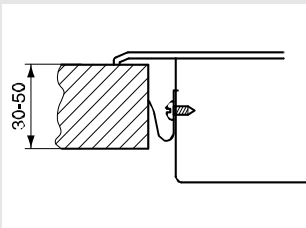

- Worktop must be placed absolutely horizontal.
- Suitably protect the edges of the cut aperture.
- Screw on the fastening elements (4) with help of fastening screws (4) on the right and left side of the hot plate.
- Connect the cooking hob to the mains power supply and to the gas supply (see instructions for the connection of the cooking hob to mains power supply and gas supply)
- Insert the hob into the cut aperture.
- Press the hob firmly towards the worktop from above.

Installation of several glass-ceramic hobs

When installing several glassceramic hobs it is necessary to separate them with intermediary short strip (to be purchased separately 286696).

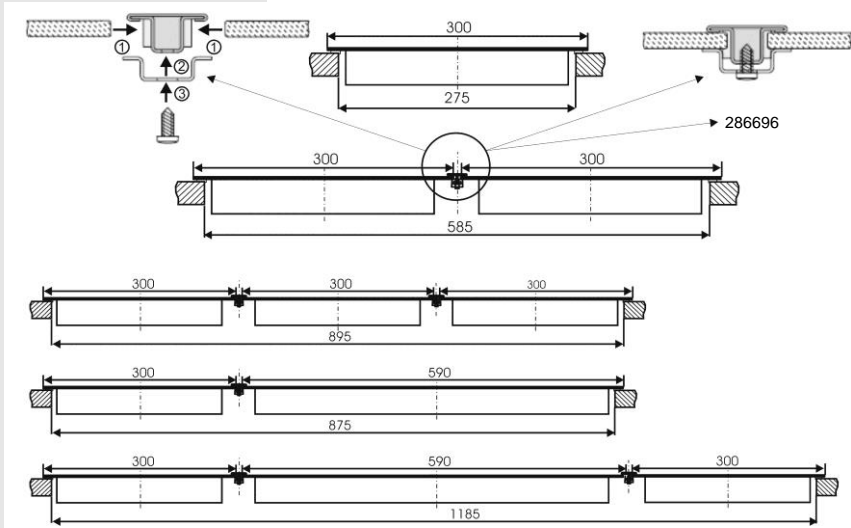

Connecting the hob to the mains

- Connections may be carried out by a qualified technician only. The earthing protection must comply with the standing regulations.
- Connection terminals are revealed when the connection box cover is removed.
- Prior any attempted connection check that the voltage indicated on the rating plate is in line with your home power supply.
- Rating plate of the ceramic glass built-in cooking hob is fixed at the bottom part of the appliance.
- The appliance is manufactured for use with the power supply voltage AC 230 V.

- The electric wiring should be equipped with a circuit breaker able to isolate the appliance from the mains in all points, with the distance between terminals of at least 3 mm in open position. This may be done by means of fuses, safety switches, etc.
- The connection should be selected in accordance with the declared charge capacity of the mains and the fuse power.
- Such appliances are allowed to be mounted on one side next to a high kitchen cabinet, the height of which may exceed that of the appliance. On the opposite side however, only a kitchen cabinet of equal height as the appliance is allowed.
- Upon the completion of installation, live wires and isolated cables must be adequately protected against accidental touching.

ATTENTION!

Before attempting any repairs on the appliance, disconnect the power supply. In accordance with the mains voltage the appliance should be connected in line with the attached diagram. The earthing wire (PE) must be connected to the terminal marked with the earthing symbol \perp .

The connection cable must lead through the relief safety device, protecting it from accidental pulling out. Upon the completion of installation switch all the hotplates on for about 3 minutes to check the proper functioning.

Installation diagram

- Improper connection may damage parts of the appliance. Such damages are not covered by warranty!
- Before attempting any connections check whether voltage indicated on the rating plate agrees with the installation in your home. Authorized person must check the user connection voltage (230 V against N) with the voltage meter!
- Place the power lead at the rear of the appliance in such way to avoid touching the rear panel of the appliance as it may become hot during the operation.

Connection may be carried out by means of:

- rubber coated connection cables, model H05 RR-F 3x1,5 with yellow-green earthing cable;
- PVC insulated connection cables, model H05 VV-F 3x1,5 with yellow-green earthing cable; or any other suitable cables.

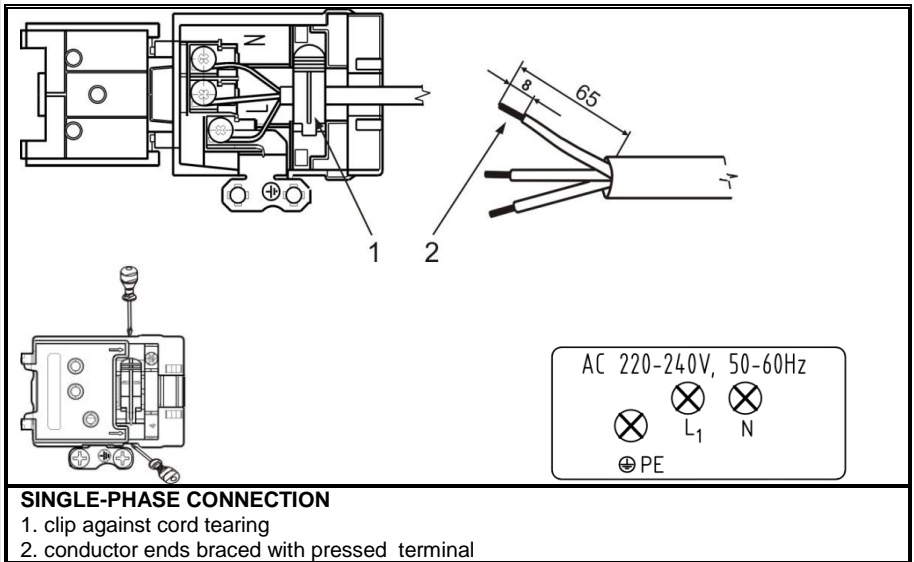

Gas connection

Safety precautions

- Connections may be carried out by a qualified technician only.
- The appliance must be connected in accordance with the standing regulations, and it may be used only in well ventilated rooms. Before any attempt to connect the appliance read carefully the instructions!
- Before installation and connection check if the local connection specifications (type and pressure of gas) correspond to the specifications of the appliance.
- The technical specifications of the appliance are indicated upon the rating plate.
- The appliance is not suitable for connection to the vapour release channel (chimney). The appliance must be installed and connected in accordance with the standing regulations. Special attention must be paid to the particular ventilation requirements.

Connection

- Connect the appliance in accordance with the regulations of the local gas supplier.
- Gas cooker is equipped with the EN 10226 R1/2 gas connection on the right side.
- The appliance is delivered with hose adapter for bottled gas (propane - butane) and with non metal sealing (for some delivery country only).
- During connection hold the elbow R 1/2 to prevent it from turning.
- Use metal or non metal gaskets for connection packing. Metal gaskets may be used only once. Thickness of non-metal gaskets can be deformed up to 25% maximally.
- Connect the appliance to the liquid gas supply by means of attested flexible hose.
- The hose may not touch the bottom side of the appliance, or the back and the top of the oven and should not go through area, where it could be clogged.
- If the kitchen element below the hob has an integrated oven, it must be fitted with the cooling fan and the connection hose must entirely be made of metal (for example flexible stainless steel gas connection hose). Connection hose must not touch the top oven panel or the hob bottom.



Check sealing of all joints and couplings after connection.

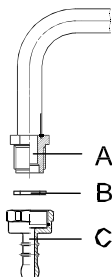

Gas connection joint

A EN 10226 R1/2 connection

B Nonmetal gasket of thickness 2 mm

C Pipe extension for liquid gas

After connection check proper functioning of burners. Gas must burn with clearly displayed blue-green flame hubs. If the flame is not stable, increase minimum power setting. Instruct the user in regard to burner button controls and read the instructions or use together.

Conversion to another type of gas

- For the conversion procedure the appliance need not be pulled out from its location.
- Before starting to work on conversion, disconnect the appliance from the mains and shut the gas inlet off.
- Replace the existing nozzles of declared nominal heat input with adequate nozzles for the new type of gas (see table).
- In case of conversion to the liquid gas propane/butane, the minimum heat input setting screw shall be tightened all the way.
- In case of conversion to natural gas, unscrew the setting screw to arrive at minimum heat input, but never for more than 1,5 turn.
- After the conversion is done, stick the new sticker with the actual gas specifications of the appliance over the old one.
- Upon completion check the gas tightness of the appliance.

Hob burners (depending on the model)

Large and auxiliary burner

- a)
1. Burner crown cap
 2. Burner crown with burner cap support
 3. Thermal probe (thermally protected burners only, only certain models)
 4. Ignition plug
 5. Nozzle
 6. Bowl of the burner

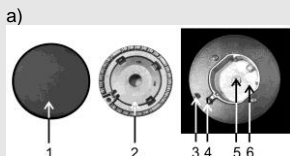

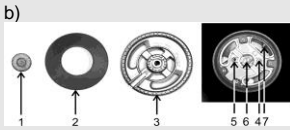

Double burner (wok) - certain models only

- b) 1. Burner cup WOK
 2. Burner crown cap
 3. Burner crown with burner cap support
 4. Thermal probe (thermally protected burners only, only certain models)
 5. Ignition plug
 6. Nozzle
 7. Nozzle

Setting elements

To provide access to the setting elements:

- Remove the cooktop grid and burner crowns with caps.
- Remove the control knobs along with the seal gaskets.

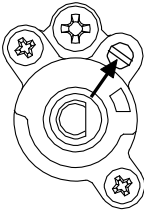

Gas faucet (depending on the model)

Twin burner model:

Minimum heat input setting screw for twin burner model.

One double burner (wok)

Minimum heat input setting screw for one double burner model:
 Gas faucet thread holds the minimum heat power setting screw for interior burner.

The side is fitted with the minimum heat power setting screw for exterior burner.

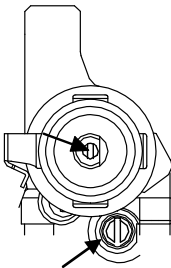

Nozzle chart - glas ceramic hob

| Type of gas | | Auxiliary burner | | Large burner | |
|---|-------------------------|------------------|------|--------------|------|
| | | max | min | max | min |
| Number Wobbe | | | | | |
| Natural gas H Ws= 45,7÷54,7 MJ/m ³ | Nominal heat input (kW) | 1 | 0,36 | 3 | 0,76 |
| | Consumption (l/h) | 95,2 | 34,4 | 285,6 | 72,4 |
| Natural gas E, E+ Ws= 40,9÷54,7 MJ/m ³ G 20, p = 20 mbar | Nozzle mark (1/100mm) | 72X | • | 128H3 | • |
| | Nozzle code | 690771 | | 438244 | |
| Liquid gas 3+, 3B/P Ws= 72,9÷87,3 MJ/m ³ G 30, p = 30 mbar | Nominal heat input (kW) | 1 | 0,36 | 3 | 0,76 |
| | Consumption (g/h) | 72,7 | 26,2 | 218,1 | 55,3 |
| | Nozzle mark (1/100mm) | 50 | 24 | 85 | 33 |
| | Nozzle code | 690780 | | 690782 | |

| Type of gas | | Double (WOK) burner | | |
|---|-------------------------|---------------------|---------------------------|---|
| | | max | min- interior flame | min - in- termediate and exte- rior flame |
| Number Wobbe | | | | |
| Natural gas H Ws= 45,7÷54,7 MJ/m ³ | Nominal heat input (kW) | 0,8/4,2 | | 1,9 |
| | Consumption (l/h) | 76,2/400,2 | | 181,0 |
| Natural gas E, E+ Ws= 40,9÷54,7 MJ/m ³ G 20, p = 20 mbar | Nozzle mark (1/100mm) | 70H1 | 147H3 | • |
| | Nozzle code | 438921 | 438922 | |
| Liquid gas 3+, 3B/P Ws= 72,9÷87,3 MJ/m ³ G 30, p = 30 mbar | Nominal heat input (kW) | 0,8/4,2 | | 1,9 |
| | Consumption (g/h) | 58,2/305,6 | | 138,3 |
| | Nozzle mark (1/100mm) | 44 | 95 | 27 |
| | Nozzle code | 438974 | 438975 | |

- Setting screws are intended for liquid gas. For natural (municipal) gas supply new setting of gas flow is required (unscrew for not more than 1,5 turn from the end position).
- ** Double burner has three nozzles. Left column nozzle must be fitted to the center of the burner, while the right column nozzle must be fitted at the side of the burner (1 pieces).
- Burner power is indicated according to the upper caloric value of Hs gas.



Caution: above works may be performed only by the expert, authorized by the gas distributor or authorized service!

After gas conversion procedure, stick a new rating plate over the old one, and check again the sealing of all gaskets and the functionality of the appliance.

Technical information

| Type | 4108 | 4109 |
|---|---------------------------------------|---------------------|
| Model | GC341UC | GCW341UC |
| Appliance dimensions (height/width/depth) mm | 46/300/510 | 46/300/510 |
| Mains voltage | 230 V ~ | 230 V ~ |
| Operating voltage | 230 V ~, 50 Hz | 230 V ~, 50 Hz |
| | A1 = small burner B = large burner | Double (WOK) burner |
| Front | 1kW / A1 | \ |
| Rear | 3kW / B | \ |
| Cooking burners altogether (kW) | 4,0 | 4,2 |
| Cookeng burners altogether - liquid gas (g/h) | 290,8 | 305,6 |
| Gas type is indicated on the rating plate. | G 20 – 20mbar | G 20 – 20mbar |
| Gas connection (right) | EN 10226 R1/2 | EN 10226 R1/2 |
| Category (GB) | I12H3B/P | I12H3B/P |
| Class | 3 | 3 |

* The built in height of the appliance is 64 mm

| PRODUCT INFORMATION REGULATION (EU) NO 66/2014 | | | | |
|--|--------------------------|------|---|---|
| | Symbol | Unit | Value | Value |
| Supplier's name or trade mark | | | GORENJE | GORENJE |
| Model identification | | | 4108 | 4109 |
| Type of hob | | |  |  |
| Number of gas burners | | | 2 | 1 |
| Energy efficiency per gas burner | EE _{gas burner} | | | |
| - small burner | | % | - | - |
| - large burner | | % | 55,1 | - |
| - double (WOK) burner | | % | - | 54,1 |
| Energy efficiency for the gas hob | EE _{gas hob} | % | 55,1 | 54,1 |

MORA MORAVIA, s.r.o., Hlubočky – Mariánské Údolí, Česká republika

454820en

WE RESERVE THE RIGHT TO ALTER THE SPECIFICATIONS WITH NO INFLUENCE ON THE OPERATION OF THE APPLIANCE.

