



Instructions for Use

GB IE MT



ELECTRIC OVEN

Dear customer!



We sincerely thank you for your purchase. We believe you will soon find ample evidence that you can really rely on our products. To make the use of the appliance easier, we attach these comprehensive instruction manual.

The instructions should aid you in getting familiar with your new appliance. Please, read them carefully before using the appliance for the first time.

In any case, please make sure the appliance was supplied to you undamaged. Should you identify and transport damage, contact your sales representative or the regional warehouse from where the product was delivered. You will find the telephone number on the receipt or delivery report. We wish you a lot of pleasure with your new household appliance.



Instructions for connection

The connection should be carried out in compliance with the instructions in the section "Connection to the power mains", and the relevant effective regulations and standards. This should only be performed by a qualified technician.

Rating plate

The rating plate indicating the basic information on the appliance is attached to the edge of the oven and it is visible when you open the oven door.

TABLE

IMPORTANT - READ BEFORE USING	5
THE APPLIANCE	5
Safety precautions.....	5
Warnings.....	5
Appliance purpose	6
APPLIANCE DESCRIPTION	7
Cooling fan	8
Recessed knob	8
THE OVEN	8
Before using the oven for the first time.....	8
Important warnings.....	8
Operating your oven.....	9
Turning off the oven.....	13
Shelf levels (depending on the model)	13
Oven accessories (depending on the model).....	13
FOOD PREPARATION	14
Baking pastry	14
Cooking / roasting meat.....	17
Grilling and browning.....	19
Preservation.....	21
Defrosting * 	22
CLEANING AND MAINTENANCE.....	23
Cleaning 	24
Door lock (only with some models).....	27
Replacing appliance parts	27
SPECIAL WARNINGS AND ERROR REPORTING	29
Important	29
INSTRUCTIONS FOR INSTALLATION AND	30
CONNECTION.....	30
Important warnings.....	30
Installation.....	30
Electrical connection.....	31
TECHNICAL CHARACTERISTICS	33
Rating plate.....	33

IMPORTANT - READ BEFORE USING THE APPLIANCE

Safety precautions

- This appliance can be used by children aged from 8 years and above and persons with reduced physical, sensory or mental capabilities or lack of experience and knowledge if they have been given supervision or instruction concerning use of the appliance in a safe way and understand the hazards involved. Children shall not play with the appliance. Cleaning and user maintenance shall not be made by children without supervision.
- **WARNING:** The appliance and its accessible parts become hot during use. Care should be taken to avoid touching heating elements. Children less than 8 years of age shall be kept away unless continuously supervised.
- **WARNING:** Ensure that the appliance is switched off before replacing lamp to avoid the possibility of electric shock.
- Do not use harsh abrasive cleaners or sharp metal scrapers to clean the oven door glass since they can scratch the surface, which may result in shattering of the glass.
- Do not use steam cleaners or high-pressure cleaners to clean the cooking hob, as this may result in an electric shock.
- The appliance is not intended to be controlled by external timers or special control systems.

Warnings

- The appliance may only be connected to the power mains by an authorized service technician or expert.
- Tampering with the appliance or non-professional repair thereof may result in risk of severe injury or damage to the product. Any repairs may only be carried out by an authorized service technician or expert.
- If the power cords of appliances located near this appliance are caught in the oven door, they can be damaged, which may in turn result in a short circuit. Therefore, keep the power cords of other appliances at a safe distance.

- The appliance is intended solely for cooking. Do not use it for any other purpose, e.g. for room heating.
- Be particularly careful when cooking food in the oven. Due to high temperatures, baking trays, baking sheets, the grid and the oven interior walls become very hot. Always use oven mitts.
- Do not line the oven walls with aluminium foil and do not place baking trays or other cookware on the oven bottom. Aluminium foil would prevent air circulation in the oven, hinder the cooking process, and ruin the enamel coating.
- Appliance operation is safe with and without tray guides.
- Oven door become very hot during operation. A third glass is installed or additional protection to reduce the temperature of the outside surface (only with some models).
- Oven door hinges may be damaged if overloaded. Do not place heavy cookware on the open oven door and do not lean against the door while cleaning the oven. Before cleaning the oven, remove the oven door (see chapter »Removing and re-installing the oven door«). Do not stand or sit on the open oven door (children!).
- Eventual mismatches in colour shades between different appliances or components within a single design line may occur due to various factors, such as different angles under which the appliances are observed, different coloured backgrounds, materials, and room illumination.



The symbol on the product or on its packaging indicates that this product may not be treated as household waste. Instead it shall be handed over to  the applicable collection point for the recycling of electrical and electronic equipment. By ensuring this product is disposed of correctly, you will help prevent potential negative consequences for the environment and human health, which could otherwise be caused by inappropriate waste handling of this product. For more detailed information about recycling of this product, please contact your local city office, your household waste disposal service or the shop where you purchased the product.

Appliance purpose

The appliance is intended for conventional preparation of food in households and should not be used for any other purpose. Individual options of use are comprehensively described in this instruction manual.

APPLIANCE DESCRIPTION

The figure represents one of the appliance models. Since a group of appliances to which these instructions apply, have different features, the instruction manual may describe functions and equipment that may not be available in your appliance.

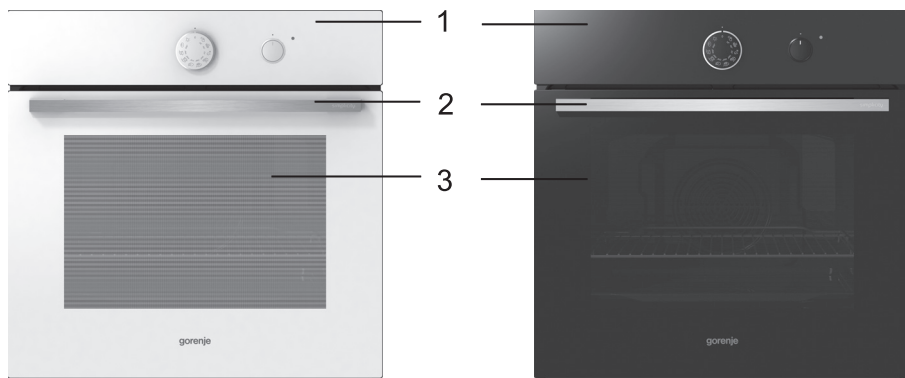

1. Control panel
2. Oven door handle
3. Oven door

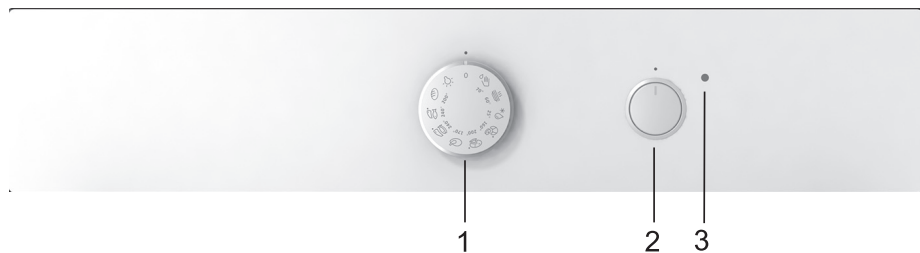

- 1 On/off button and oven mode selector
- 2 Oven temperature setting button
- 3 Oven control lamp. The lamp is on until the oven temperature is rising and goes off when the set temperature is reached (only with some models).

(only with some models)

Cooling fan

The appliance features a built-in cooling fan which cools the appliance housing and control panel.

Recessed knob

- First, push the knob slightly, to make it pop out of the control panel. Then, select the operation mode and the temperature, or the cooking zone power level.
- After each use, turn the knob back to the off position and press it back into its recessed position when it is flush with the control panel front.

THE OVEN

Before using the oven for the first time

- Remove all accessories from the oven and clean them with warm water and a conventional detergent. Do not use abrasive cleaning aids.
- When the oven is heated up for the first time, a specific odor of a “new appliance” will be discharged; therefore, ventilate the room thoroughly while the oven heats up.

Important warnings

- Use dark, black silicon coated or enamel coated baking trays, as these transmit the heat particularly well.
- Only preheat the oven if specifically stated in the recipe or in the instruction tables herein.
- Heating up an empty oven uses a lot of energy; therefore, a lot of power is saved if several types of pastry are cooked consecutively, as the oven is already heated up.
- Approximately ten minutes before the anticipated end of the cooking process, the oven may be turned off. This way, you will save some power and make use of the accumulated heat.
- Note: When cooking is completed, the cooling fan will stop operating. If you leave the dish in the oven, steam could evaporate from it and condense on the front panel and the oven door. In order to prevent condensation, set the program selector switch to the »light« position. Thus, the cooling fan will continue to operate and cool the oven, preventing the accumulation of condensate.

Operating your oven



To operate your oven, use the on/off button and the oven mode selector dial, and the temperature setting button.



















Temperature setting button.

Rotate **the selector dial** to the desired cooking mode/system or the desired type of food.

Cooking by selecting the type of food or operation mode

Use this mode when you wish to prepare any type and quantity of food. It allows you to choose the heating system and temperature.

Cooking table for selected types of food

Symbol	Dish/ Function	Suggested cooking time (°C)	Maximum possible temperature setting (°C)	Preset cooking time (h/min)	Quantity (kg)	Guide level (height) (from bottom)	Warning	Preset operation mode
	Bread	190	275	0:55	1	2	Baking in shallow baking tray / tin.	
	Cutlets, fish (smaller pieces)	240	275	0:23	2x0,2	4 3*	Cooking / grilling on the grid placed in guides 4, 3*; a dip tray should be placed in guides 2, oven door should be closed. Turn the food halfway through.	
	Cutlets, chops, fish (larger pieces)	240	275	0:25	4x0,2	4 3*	Cooking / grilling on the grid placed in guides 4, 3*; a dip tray should be placed in guides 2, oven door should be closed. Turn the food halfway through.	
	Chicken	170	275	1:05	1	2	Roast the chicken on a grid in the 2nd guide, installing the dip tray in the bottom guide.	
	Pizza	200	275	0:19	1x0,5	2	Baking in the shallow baking tray / tin.	
	Small pastry, cookies	160	275	0:26	2x0,3	2,3	Baking in shallow baking trays in two levels / guides simultaneously.	
	Defrosting	-	-	-	-	2	Place the food on the grid, the dip tray should be installed in the bottom guide.	
	Plate warmer	60	230			2		
	Cleaning	70	90	0:30	-	2	Pour 0.6 l of water into the baking tray and place it into the bottom guide. After 30 minutes, the food remains on the oven enamel surfaces will soften and they can be removed with a damp cloth.	

Note: A dot next to the food symbol means that the oven should be preheated to the indicated temperature before the food is placed in it. With large and small grill heater, preheating takes approximately 5 minutes.

Oven lighting

With some models, there are two interior lighting lamps: one on the upper part of the back wall, and the other, additional lamp on middle of the right side wall. Oven lighting can be selected independently, without selecting another function. With all other modes of operation, the oven lighting is turned on automatically when the operation mode is selected.

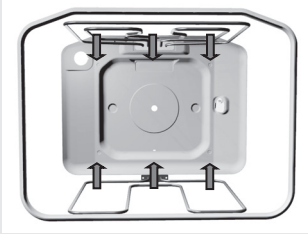

Upper / lower heater

The heaters on the upper and lower side of the oven radiate heat uniformly and evenly into the oven interior. Pastry and meat can be cooked on one shelf level only. Suggested cooking time 200°C.



Grill

Only the infra / grill heater, a part of the large grill, will operate.

It is appropriate for grilling smaller quantities of sandwiches, sausages, or for toasting bread. Suggested cooking time 240°C.



Large grill

With this operation mode, the upper heater and the infra heater are activated simultaneously. The infra heater installed on the oven interior ceiling radiates heat directly. To boost the heating effect or to make optimal use of the entire area of the oven grid, the upper heater is also activated.

This operation mode is appropriate for cooking smaller chunks of meat, such as steaks, roasts, chops, ribs, etc. Suggested cooking time 240°C.

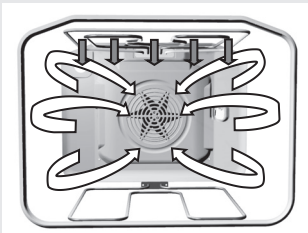

Grill & fan

With this operation mode, the infra heater and the fan are activated simultaneously. It is appropriate for grilling meat and large chunks of meat or poultry on one shelf level. Also appropriate for cooking food au gratin or browning. Suggested cooking time 170°C.

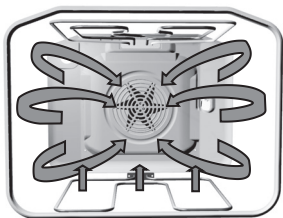

Hot air and lower heater

With this operation mode, the lower heater and the hot air fan operate simultaneously. This is particularly convenient for making pizza. Also ideal for moist or heavy pastry, fruit cakes made of leavened dough, short pastry, or cheesecakes.

Suggested cooking time 200°C.



Hot air

With this operation mode, the round heater and the fan operate simultaneously. The fan at the oven back wall causes the hot air to circulate constantly around a roast of pastry. This operation mode is appropriate for roasting meat and making pastry on several shelves simultaneously. Cooking temperature should be set lower than with conventional operation modes.

Suggested cooking time 160°C.



Defrosting

With this mode, the air is circulating without any heater being turned on. Only the fan is in operation. This is used for slow defrosting or thawing of frozen food.

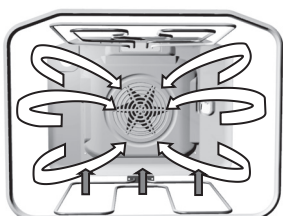

Lower heater and fan

In this mode, the lower heater and fan operate simultaneously. Such mode of operation is appropriate for heating the plates, as well as for baking low-risen pastry and preserving fruit and vegetables.

Use the first guide from the bottom and baking trays that are not too high, as the heated air should be allowed to circulate around the upper part of the food as well.

Suggested cooking time 60°C.



Lower heater

Lower heater may be used to clean your oven. Further details on cleaning can be found in the chapter "Cleaning and Maintenance".

Only the heater in the bottom of the oven will operate in this mode. Select this operation mode when you wish to brown the lower side of the pastry (e.g. when baking a juicy sponge cake with fruit filling).

Turning off the oven

After the completion of the cooking or baking process, rotate the selector dial back to “zero” position; decreasing temperature will be indicated on the temperature display until it reaches 50° C.

Shelf levels (depending on the model)

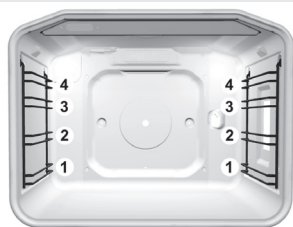

- Pribor (rešetka, nizki in globoki pekač) lahko vstavite v pečico na 4 nivoje.
- Upoštevajte, da se nivoji pečenja vedno štejejo od spodaj navzgor! (V tabelah pečenja v nadaljevanju so opisani posamezni nivoji).
- Pri žičnih vodilih morate rešetko in pekače vedno vstaviti v vodilno rego, ki jo določata žična profila.

Oven accessories (depending on the model)

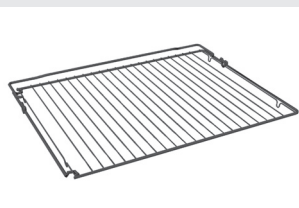

The **grid** onto which the container with food, or the food directly, is placed.

 A safety stop is fitted on the grid and on the guides. To pull out the grid, lift it slightly when it hits the stop.

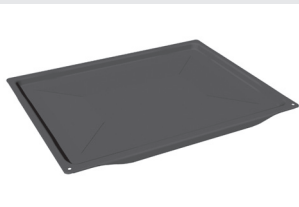



Shallow baking tray is only intended for baking pastry and cakes.



Deep baking tray is intended for baking meat and moist pastry; it is also intended as a drip tray.

 Unless you are using the grill, or the deep baking tray is used only as a drip tray when spit-roasting, the deep tray should not be inserted into the first guide.

Baking pastry

- For baking pastry, use the ,  or  mode of operation. (Oven operation with the selected mode, or system, depends on the appliance model).
- When baking pastry, always remove the fat filter.

Instructions

- When baking pastry, always observe the instructions on the shelf / guide level, temperature, and cooking time indicated in the pastry baking table. Do not be prejudiced by experience you may have with other ovens. The values indicated in the cooking table are defined and checked especially for this particular oven.
- If the baking table does not specifically address a particular type of pastry, see the information for a similar type of pastry.

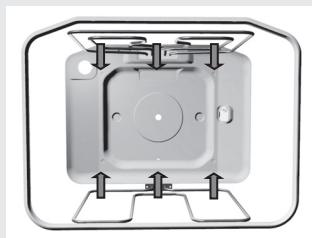

Baking pastry with upper and lower heater

- Bake the pastry at one level only.
- Upper / lower heater combination is particularly appropriate for baking various types of pastry, bread, and meat.
- Use dark-colored baking trays. Light-colored trays reflect the heat, which leads to poorer cooking (browning) results. Always place the models on the grid. If you are using the supplied baking tray, remove the grid.
- Preheating will shorten the cooking time. Place the dish into the oven only when the selected temperature has been reached, i.e. when the control lamp (heater operation lamp) goes off for the first time.

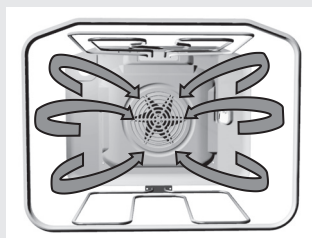

Baking pastry with hot air

Baking pastry with hot air is particularly convenient when you wish to bake on several shelf / guide levels simultaneously, especially when preparing bite-size pastry in shallow trays. Preheating is recommended, and the use of the second and third guide level. This mode is also appropriate for moist pastry and fruit cakes (in this case, bake on a single level only).

- The temperature is normally set lower than when baking with the upper/lower heater combination (see also the pastry baking table).
- Various types of pastry can be baked simultaneously, if the required temperature is at least approximately the same for all.
- Baking time can vary, even for equal baking trays. When

baking in several baking trays simultaneously – on two or even three levels, baking time for each tray can be different. You may have to remove one of the trays sooner (normally, this would be the uppermost tray).

- If possible, prepare bite-size pastry, such as cupcakes, in the same thickness and height. Unevenly sized pastry will be unevenly browned!
- When baking several types of pastry simultaneously, there will be a significant amount of vapor in the oven, resulting in accumulation of condensate on the oven door.

Tips on baking pastry

Is the pastry completely done?

Use a wooden stick to pierce the pastry at the highest point. If there are no traces of dough when the stick is removed, the pastry is done. Turn off the oven and use the remaining accumulated heat.

The pastry has collapsed

Check the recipe. Next time, use less liquid. Observe the instructions on mixing / kneading time, especially when using small household appliances.

The pastry is too light-colored

Next time, use a dark-colored baking tray, place the tray one guide level lower, or turn on the lower heater towards the end of the cooking process.

The pastry with a moist filling (e.g. cheesecake) is not completely done

Next time, reduce the temperature and extend the cooking time.

Notes on the pastry baking table:

- Two values are indicated for temperature, lower and upper. Initially, set the lower temperature; if the pastry is not brown enough, increase the temperature next time.
- Cooking times are given as an estimate and may vary subject to a number of circumstances.
- The value printed in bold in the temperature table indicates the most appropriate operating mode for a particular type of pastry.
- The indication * means that the oven should be preheated with the corresponding operating mode selected.
- When using baking paper, make sure it is resistant to high temperature.

Pastry baking table for combined upper and lower heater or hot air operating mode

Type of pastry	Guide (from the bottom)	Temperature (°C) □	Guide (from the bottom)	Temperature (°C) ⊗	Cooking time (minutes)
Sweet pastry					
Marble cake, ring cake	1	160-170	1	150-160	50-70
Rectangle-shaped cake	1	160-170	1	150-160	55-70
Cake made in cake tin	1	160-170	2	150-160	45-60
Cake tin cheesecake	1	170-180	2	150-160	65-85
Fruit cake, short pastry	1	180-190	2	160-170	50-70
Fruit cake with dressing	1	170-180	2	160-170	60-70
Sponge cake*	1	170-180	2	150-160	30-40
Cake with icing	2	180-190	2	160-170	25-35
Fruit cake, mixed dough	2	170-180	2	150-160	45-65
Cherry cake	2	180-200	2	150-160	35-60
Sponge cake roll*	2	180-190	2	160-170	15-25
Leavened dough cake	2	160-170	2	150-160	25-35
Hefezopf (leavened dough)	2	180-200	2	160-170	35-50
Christmas cake	2	170-180	2	150-160	45-70
Apple pie	2	180-200	2	170-180	40-60
Oven-baked donuts	1	170-180	2	150-160	40-55
Savory pastry					
Quiche Lorraine	1	190-210	2	170-180	50-65
Pizza*	2	210-230	2	190-210	25-45
Bread	2	190-210	2	170-180	50-60
Buns*	2	200-220	2	180-190	30-40
Bite-size pastry					
Short pastry - cookies *	2	160-170	2	150-160	15-25
Merengue *	2	160-170	2	150-160	15-28
Leavened dough	2	180-190	2	170-180	20-35
Puff pastry	2	190-200	2	170-180	20-30
Choux pastry (cream filled)	2	180-190	2	180-190	25-45
Soufflés					
Rice soufflé	1	190-200	2	180-190	35-50
Fresh cheese soufflé	1	190-200	2	180-190	40-50
Frozen pastry					
Apple, cheese pie	2	180-200	2	170-180	50-70
Cheesecake	2	180-190	2	160-170	65-85
Pizza	2	200-220	2	170-180	20-30
French fries for oven *	2	200-220	2	170-180	20-35
Croquettes	2	200-220	2	170-180	20-35

Note: Guide number refers to the grid onto which smaller baking trays or cake tins are placed, and to shallow baking tray. The deep baking tray should not be inserted into the first guide.

Settings table for baking pastry with hot air and lower heater

Type of pastry	Guide (from the bottom)	Temperature (°C) Ⓢ	Cooking time (minutes)
Cheesecake (750g cheese) - short pastry	2	150-160	65-80
Pizza * - leavened dough	2	200-210	15-20
Quiche Lorraine - short crust dough	2	180-200	35-40
Apple pie with icing - leavened dough	2	150-160	35-40
Fruit cake - mixed dough	2	150-160	45-55
Apple pie - flaky pastry	2	170-180	45-65

Cooking / roasting meat

- To cook meat, use the operating modes and .
- Data printed in bold represent the most appropriate operation mode for a particular type of meat.
- When cooking meat, the use of the fat filter is recommended (depending on the model).

Tips on using the cookware

- Meat can be cooked in enamel coated cookware, tempered glass (Pyrex) cookware, clay, or cast iron cookware.
- Stainless steel baking trays are less appropriate because they reflect the heat.
- If the roast is covered, it will remain juicier, and the oven will not be as dirty.
- In an open baking tray, the roast will brown sooner.

Some notes on cooking meat

- The meat cooking table indicates recommended temperatures, guide/shelf level, and cooking time. Since cooking times depend strongly on the type, weight, and quality of meat, they may have to be adjusted.
- Cooking meat, poultry, and fish in an oven is economical only at weights exceeding 1 kg.
- When cooking meat, add enough liquid to prevent the fat and juices from the meat to be burnt onto the baking tray. This means that, in case of longer cooking times, the roast should be checked upon every one in a while, and liquid should be added.
- After approximately half of cooking time, turn the roast around, especially when baking in a tray. For better results, start the cooking with the upper side turned downwards.
- When cooking larger chunks of meat, condensate may accumulate on the oven door. This is a natural phenomenon which does not affect the operation of the appliance. After cooking, wipe the door and door glass dry.
- In order to prevent accumulation of condensate, do not let the dishes to cool down in the oven.

Meat cooking table for upper/lower heater combination or with hot air

Type of meat	Weight (g)	Guide (from bottom)	Temperature (°C) □	Guide (from bottom)	Temperature (°C) ⊕	Cooking time (min.)
Beef						
Beef roast	1000	2	190-210	2	180-190	100-120
Beef roast	1500	2	190-210	2	170-180	120-150
Roastbeef, medium done	1000	2	200-210	2	180-200	30-50
Roastbeef, well done	1000	2	200-210	2	180-200	40-60
Pork						
Pork roast, incl. skin	1500	2	180-190	2	170-180	140-160
Pork belly	1500	2	190-200	2	170-180	120-150
Pork belly	2000	2	180-200	2	160-170	150-180
Shoulder	1500	2	190-200	2	160-170	120-140
Pork roll	1500	2	190-200	2	160-170	120-140
Cutlet	1500	2	180-200	2	160-170	100-120
Minced meat roast (pork meat loaf)	1500	2	200-210	2	170-180	60-70
Veal						
Veal roll	1500	2	180-200	2	170-190	90-120
Veal joint	1700	2	180-200	2	170-180	120-130
Lamb						
Lamb loin	1500	2	190-200	2	170-180	100-120
Sheep joint	1500	2	190-200	2	170-180	120-130
Venison						
Rabbit loin	1500	2	190-200	2	180-190	100-120
Deer joint	1500	2	190-200	2	170-180	100-120
Wild boar joint	1500	2	190-200	2	170-180	100-120
Poultry						
Chicken, whole	1200	2	190-200	2	180-190	60-80
Chicken	1500	2	190-200	2	180-190	70-90
Duck	1700	2	180-190	2	160-170	120-150
Goose	4000	2	160-170	2	150-160	180-200
Turkey	5000	2	150-160	2	140-150	180-240
Fish						
Whole fish	1000	2	190-200	2	170-180	50-60
Fish soufflé	1500	2	180-200	2	150-170	50-70

Note: The guide indication applies to the deep tray; smaller trays should be placed on the grid inserted into the first guide - □; 1st - 2nd guide ⊕ - . (The deep tray may not be inserted into the first guide from the bottom).

Grilling and browning

- When grilling meat, you should be particularly careful. The high temperatures and infra heater heat the grid and other parts of the oven to very high degrees; use protective kitchen gloves and special meat tongs.
- Hot fat may squirt out of pierced meat (e.g. from sausages). To avoid burning your skin or eyes, use meat tongs.
- When grilling meat, control the process at all times. Due to high temperature, meat can be burnt quickly!
- Do not let children anywhere near the grill.
- Roasting with infra heater is recommended for crisp and low-fat preparation of grilled sausages, meat chunks, and fish (steak, chops, salmon fillets, etc.) or toasted bread, as well as for browning.

Some tips on using the grill function

- When using the grill, oven door should always be closed.
- The cooking table for grilling indicates recommended temperature, guide level, and cooking time. Since cooking time depends strongly on the type, quality, weight, and quality of meat, it may have to be adjusted.
- When cooking meat, the use of fat filter is recommended (depending on the model).
- The infra heater (Large grill and Grill operating mode) should be preheated for five minutes.
- When cooking on a grid, spread some oil over it to prevent the meat from sticking onto it.
- Place thin slices of meat on the grid and insert it into the fourth guide level.
- Insert a baking tray, which will serve as a drip tray in this case, into the first or second guide level to collect the dripping fat and meat juices.
- Grilled meat should be turned halfway through the cooking. Cook the first side somewhat longer than the other one.
- When grilling larger chunks of meat on a grid (chicken, fish), insert the grid into the second level and the drip tray into the first level.
- Thinner slices of meat should only be turned once, while the thicker ones should be turned several times. Use meat tongs to turn the meat around, to prevent too much juice to be lost.
- Darker meat will brown better and sooner than pork or veal.
- After using the grill, clean the oven and accessories each time to prevent the dirt to be burnt onto the oven the next time you use it.

Cooking table - Large grill

Type of food	Weight (g)	Guide level (from bottom)	Temperature (°C) □	Temperature (°C) □	Cooking time (min)
Meat and sausages					
4 beef loin chops, rare	180g/pc	4	240	-	14-16
4 beef loin chops, medium	"	4	240	-	16-20
4 beef loin chops, well done	"	4	240	-	18-21
4 pork neck chops	"	4	240	-	19-23
4 cutlets	"	4	240	-	20-24
4 veal steaks	"	4	240	-	19-22
6 lamb cutlets	100g/pc	4	240	-	15-19
8 grill sausages	100g/pc	4	240	-	11-14
3 pcs of meatloaf	200g/pc	4	240	-	9-15
1/2 chicken	600g	2	-	180-190	25 (1.side) 20 (2. side)
Fish					
Salmon slices	600	3	240	-	19-22
4 trout	200g/pc	2	-	170-180	45-50
Toasted bread					
6 slices white bread	/	4	240	-	1,5-3
4 slices of mixed flour bread	/	4	240	-	2-3
Toasted sandwich	/	4	240	-	3,5-7
Meat / poultry*					
Duck*	2000	2	210	150-170	80-100
Chicken*	1500	2	210-220	160-170	60-85
Pork roast	1500	2	-	150-160	90-120
Pork shoulder	1500	2	-	150-160	120-160
Pork joint	1000	2	-	150-160	120-140
Roastbeef / beef loin	1500	2	-	170-180	40-80
Vegetables au gratin **					
Cauliflower, kale	750	2	-	210-230	15-25
Asparagus	750	2	-	210-230	15-25

Note: the guide level refers to the grid on which you place the meat; in the section meat/poultry, the guide level refers to the deep tray, while with chicken, it refers to the grid. When cooking meat in a tray, make sure there is enough liquid in the tray to prevent the meat from burning; approximately halfway through the cooking progress, turn the chunk of meat around. When grilling meat on the grid, insert the deep tray into the first or second guide; this way, it will serve as a drip tray (see tips on grilling meat).

Recommendation: Dry the trout with a paper towel. Put some parsley, salt, and garlic into the fish abdomen, oil it from the outside, and place it on the grid. Do not turn during grilling.

* This type of meat can also be prepared on a roast spit (see instructions for spit roasting).

** Vegetables are first partly cooked and covered in béchamel sauce and grated cheese. Use the smaller glass baking tray and place it on the grid.

Cooking table - grill

Food type	Weight (g)	Guide level (from bottom)	Temperature (°C)	Temperature (°C)	Cooking time (min.)
Meat and sausages					
2 beef loin stakes, well done	180g/pc	4	240	-	18-21
2 cutlets		4	240	-	20-22
2 pork neck steaks	180g/pc	4	240		18-22
4 grill sausages	100g/pc	4	240	-	11-14
4 toasted sandwiches		4	240	-	5-7
Toast - browning		4	240		3-4
3 trout - on the grid	200g/pc	2	-	160-170	40-50
Chicken - on the grid	1500g	2	-	160-170	60-80
Pork shoulder - deep tray	1500g	2	-	150-160	120-160

Preservation

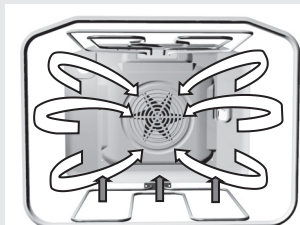

For food preservation, use the lower heater + fan operating mode.

Prepare the food to be preserved and the jars as usually. Use conventional jars with a rubber sealing and glass cover. Do not use jars with threaded or metal covers and metal cans / tins. Preferably, the jars should be of the same size, filled with the same type of food, and tightly sealed. Up to six one-liter jars can be placed into the oven simultaneously.

- Only use fresh food.
- Pour approximately one liter of hot water (about 70°C) into the deep baking tray to provide the required humidity level in the oven. Place the jars into the oven in such way that they are not in contact with the walls and each other (see figure). Rubber seals should be wetted before use.
- Insert the deep tray with the jars into the second guide level from bottom up. During preservation, observe the jars; cook until the contents of the jars starts to boil - bubbles appear in the first jar. Please note the cooking times from the preservation table below.

Preservation table

Food to be preserved	Quantity	 T=170-180°C, until boiling / bubbling (min.)	After appearance of bubbles	Standing time (in the oven (min))
Fruit				
Strawberries	6x1 liter	approx. 40-55	turn off	25
Stone fruit	6x1 liter	approx. 40-55	turn off	30
Apple puree	6x1 liter	approx. 40-55	turn off	35
Vegetables				
Sour gherkin	6x1 liter	approx. 40 do 55	turn off	30
Beans, carrots	6x1 liter	approx. 40 do 55	Set to 120°C, 60 min	30

Durations: given in the chart are approximate only. Actual time may vary due to differences in room temperature, number of jars, quantity and temperature of the fruit and vegetables to be preserved, etc. Before turning off the oven (for fruit) or setting a lower temperature (for some types of vegetables), make sure there are actually visible bubbles in the jars. Important: Observe carefully when the bubbles appear in the first jar.

Defrosting *

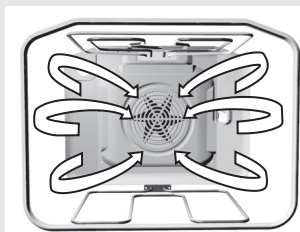

- Air circulating in the oven may speed up the process of defrosting frozen food. To do this, set the oven to "Defrosting" mode.
- Food appropriate for defrosting includes cakes with heavy cream or butter-based filling, other cakes and pastry, bread, buns, and deep-frozen fruit.
- For reasons of hygiene, meat and poultry should not be defrosted in an oven.

If possible, turn the food around or mix several times to make sure they are defrosted evenly.

CLEANING AND MAINTENANCE

Do not use a steam cleaner or a high-pressure steam cleaner to clean the appliance. Before you start cleaning the appliance, disconnect it from the power mains and let it cool down.

Appliance housing front

Clean the surfaces with liquid non-abrasive detergents intended for smooth surfaces, and a soft cloth. Apply the detergent on the cloth and wipe off the dirt; then, rinse with water. Do not apply the detergent directly on the surfaces. Do not use aggressive or abrasive cleaners, sharp objects or steel wool, as these will scratch the appliance.

Aluminum surfaces

Aluminum surfaces should be cleaned with non-abrasive liquid detergents intended for such materials. Apply the detergent on a wet cloth and clean the surface; then, rinse the surface with water. Do not apply the cleaner directly on the aluminum surface. Do not use abrasive cleaners or abrasive sponges. The surface should not come into contact with oven cleaning sprays.

Stainless steel front panels

(only with some models)

Clean the surface with a mild cleaner (soapsuds) and a soft sponge that will not scratch the material. Do not use abrasive or solvent-based cleaners. If these instructions are ignored, the housing surface can be damaged.

Lacquer-coated and plastic surfaces

(only with some models)

Clean the buttons / knobs and the door handle with a soft cloth and liquid detergents intended for cleaning smooth lacquer-coated surfaces. You may also use the cleaners made especially for this type of surfaces; in this case, follow the manufacturer's instructions.

We do not recommend washing the knobs in a dishwasher.

WARNING: The above surfaces should never come into contact with oven cleaning sprays, as these will permanently damage the aluminum parts.

Oven

- The oven can be cleaned in conventional manner (with detergents, oven spray), but only when there is very dirty and when the stains are particularly stubborn.
- After the end of the cooking process, turn the program selector knob and the temperature selector knob back to the starting position. After the end of the cooking process, turn the program selector knob and the temperature selector knob back to the starting position.  and set the temperature to 70 °C. Pour 0.6 l of water into a glass or shallow baking dish and insert it into the lower guide. After thirty minutes, the food residues on the enamel will have softened, allowing you to wipe them with a damp cloth.

When dealing with stubborn stains, please not the following:

The oven should be cooled down before each cleaning process.

- Clean the oven and accessories after each use to prevent the dirt from being burnt onto the oven.
- The easiest way to remove grease is by using warm soapsuds while the oven is still warm.
- In case of particularly stubborn dirt, use the conventional oven cleaners. Then, rinse the oven thoroughly with clean water to remove all residues of the cleaner.
- Never use aggressive cleaners such as steel wool, abrasive dishwashing sponges, stain removers, etc.
- Lacquer-coated, stainless steel, and zinc-coated surfaces, as well as aluminum parts, should never come into contact with oven cleaning sprays, as these may cause damage and discoloration. The same applies for the thermostat sensor (if the cooker features a timer with a probe) and the heaters accessible at the upper part.
- When purchasing and dispensing detergents, consider the environment and observe the instructions provided by respective cleaning agent manufacturers.

Practical tip

- When cooking larger fatty chunks of meat, we recommend wrapping them in aluminum foil of a suitable cooking bag, to prevent the grease from being splattered on the oven interior walls.
- When grilling meat on the grid, place a drip tray underneath.

Accessories

Wash the accessories (baking trays, grid, etc.) with hot water and some conventional detergent.

Special enamel coating

The oven, interior side of the door, and baking trays, are covered with special enamel that has a smooth and resistant surface. This special layer enables easier cleaning at room temperature.

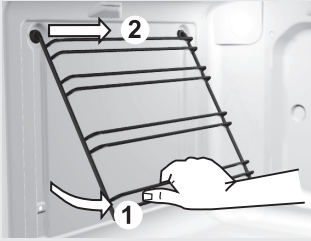

Removing wire guide racks

To facilitate cleaning of the oven interior side walls, the wire guide rack can be removed.

- Hold the guide rack by its lower end and rotate it inwards; then, remove them from the holes on the upper side.
- Clean the guide racks guides only with conventional cleaners.
- After cleaning, simply re-hang the guide rack in the holes provided and pull the downwards.

REMOVING INSIDE DOOR GLASS - APPLIES TO PREMIUM FULL-GLASS DOOR

Door glass can also be cleaned from the interior side; however, door has to be removed first (see section on removing and replacing the oven door).

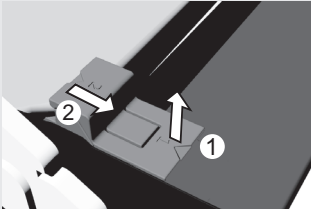

figure 1

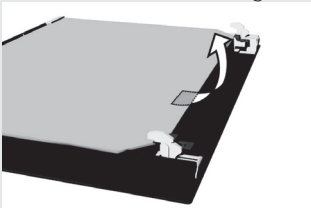

figure 2

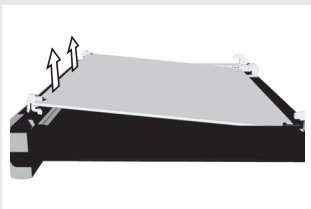

figure 3

- Slightly lift the supports on the left and right side of the door (marking 1 on the support) and pull them away from the glass (marking 2 on the support) (see Figure 1).
- Hold the door glass by the lower edge, slightly lift it so that it is no longer attached to the support, and remove it (Figure 2).
- To remove the third inside glass (only with some models), lift and remove it. Also remove the rubbers on the glass (Figure 3).

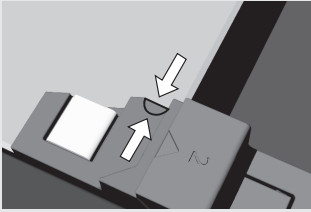

figure 4

- To replace the door, observe the reverse order.
Note: To replace the glass, make sure the markings (crescent) on the door and the glass are aligned (Figure 4).

REMOVING AND REPLACING THE OVEN DOOR WITH A SINGLE-AXIS HINGE (depending on the model)

- a) Conventional closing
- b) Soft closing system (GentleClose) - the system absorbs the shock from door closing. It allows simple, quiet, and smooth closing. A gentle push (to a 15° angle relative to the closed door position) is enough for the door to close automatically and softly.



If the force applied to close the door is too strong, the effect of the GentleClose system is reduced or the system will be bypassed for safety.

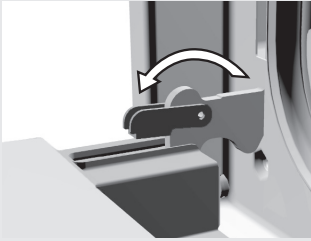

figure 1

- Fully open the oven door and rotate the stoppers all the way back - applies to conventional door closing (Figure 1).

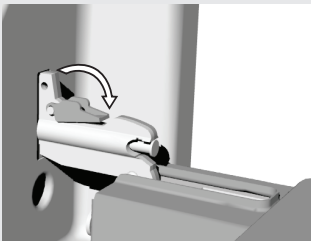

figure 2

- If the appliance is fitted with the GentleClose system, flip the door latches back to a 90° angle (Figure 2).

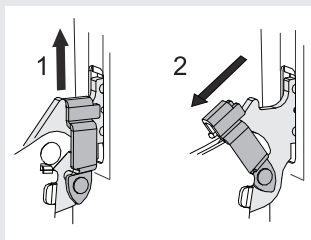
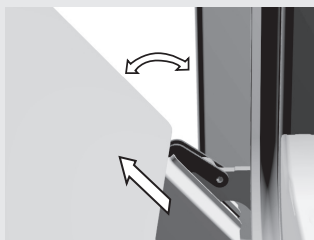

figure 3

- If the appliance is fitted with the GentleClose system, slightly lift the door latches and pull them towards you.



- Slowly close the door until the latches are aligned with the slots. Slightly lift the door and pull it out from both hinge slots on the appliance.
- Then, completely open the door and rotate the attachment clips back to their initial position. Slowly close the door and check, if they close properly. If the door does not open or close correctly, make sure whether the hinge notches are correctly placed in their seat hinges.

Attention

Always make sure the hinge attachment clips are firmly seated in their supports when installing the door. If this is not the case, the main hinge that is operated by a strong spring may be released any time while installing or removing the door. Risk of physical injury.

Door lock (only with some models)

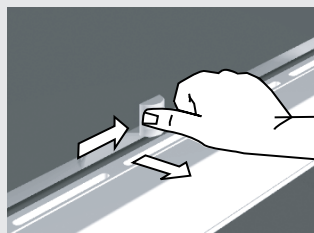

- Oven door is fitted with a door lock that prevents it from being open until the lock is released. Door lock is opened by a slightly pressing your thumb to the right and simultaneously pulling the door outwards.
- When the oven door is closed, the door lock automatically returns to its initial position.

Note: If the door lock is supplied with the appliance, attach it under the appliance control panel in compliance with the instructions for installation, which are supplied with the lock.

Replacing appliance parts

The oven lamp base and socket are under voltage. There is a risk of electric shock!

Before replacing the oven lighting bulb, disconnect the appliance from the power mains by removing the fuses or tripping the main network switch.



Oven bulb

(only with some models)

Oven bulb is considered a replacement ware part and is not covered by the warranty. Replace the bulb with a new one with the following specifications: socket E 14, 230 V, 25 W, 300°C.

- Unscrew the glass cover in the counterclockwise direction, replace the bulb, and replace the cover.

Bulb lamps used in this appliance are special purpose lamps selected for household appliances use only. They are not suitable for household room illumination.

SPECIAL WARNINGS AND ERROR REPORTING

During the warranty period, any repairs may only be performed by service technicians authorized by the appliance manufacturer.

Before starting the repair, the appliance must be disconnected from the power mains by removing the fuse or by removing the mains cord from the wall outlet.

Unauthorized tampering and repairs may cause the risk of electric shock and short circuit; therefore, do not attempt them yourselves. Leave such tasks to an expert or an authorized service technician.

In case of minor faults or problems with the appliance operation, check the following instructions to see whether you can eliminate the causes by yourselves.

Important

A visit by a service technician during the warranty period will be charged if the appliance is not functioning because of improper use. Store these instructions in a place where they are always readily accessible; if you pass the appliance on to another person, the instructions should also be included.

Following is some advice on rectifying some common problems.

The main fuse is tripped repetitively	<ul style="list-style-type: none">• Call a service technician!
Oven interior lighting does not work	<ul style="list-style-type: none">• The process of replacing the bulb is described in the section “Appliance part replacement”.
The oven does not heat up...	<ul style="list-style-type: none">• Was the temperature and operating mode selected appropriately?• Is the oven door closed?
The pastry is not cooked thoroughly...	<ul style="list-style-type: none">• Have you removed the grease filter?• Did you observe the instructions and tips from the section “Baking pastry”?• Did you follow the instructions in the baking table closely?

If the problem persists despite observing the instructions above, call an authorized service technician. Elimination of any errors or warranty claims that resulted from improper connection or use of the appliance is not covered by our warranty. In such cases, the costs of repair are borne by the user.

INSTRUCTIONS FOR INSTALLATION AND CONNECTION

Important warnings

- The appliance may only be connected by a qualified expert.
- The appliance should be fitted with a device that disconnects it from all poles of the home network (an omnipolar switch), with at least 3 mm of distance between the contacts in open position. LS-switches or fuses are appropriate.
- To connect the appliance, use the rubber mains cords (type HO5RR-F with the green/yellow earth wire), PVC insulated (type HO5VV-F with the green/yellow earth wire), or other equivalent or superior cables.
- Veneer, glue, or plastic finish of the furniture next to which the cooker is installed, should be treated heat resistant (>75°C). If the veneers are not high temperature resistant, they may be deformed.
- Packaging (plastic foil, polystyrene, etc.) must be kept out of reach of children, as it can be a source or threat to them. Small parts can be swallowed by the children, and the foils are hazardous because of the risk of suffocation.

Installation

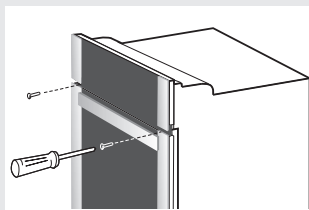

- Veneer or other finish of the furniture the appliance is being built into should be processed with heat-resistant glue (100°C); otherwise, high temperatures may cause them to deform.
- Before installing the appliance, remove the back wall from the piece of kitchen furniture the appliance is being built into, along the entire length of the cutout.
- The installation cutout should be dimensioned as indicated in the figure.
- The bottom panel of the piece of kitchen furniture (max. 530 mm) should always be shorter than the side walls to enable adequate air circulation.
- Level the piece of furniture the appliance was built into with a spirit level.
- The piece of kitchen furniture the appliance is built into must be secured against movement, e.g. attached to the adjacent pieces of kitchen furniture.
- Push the appliance into the kitchen furniture element enough that the guides for the screws that are inserted in the oven frame holes are placed against the kitchen element side walls.
- When attaching the appliance, make sure the screws are not fastened too strongly as this may damage the furniture or the appliance enamel coating.

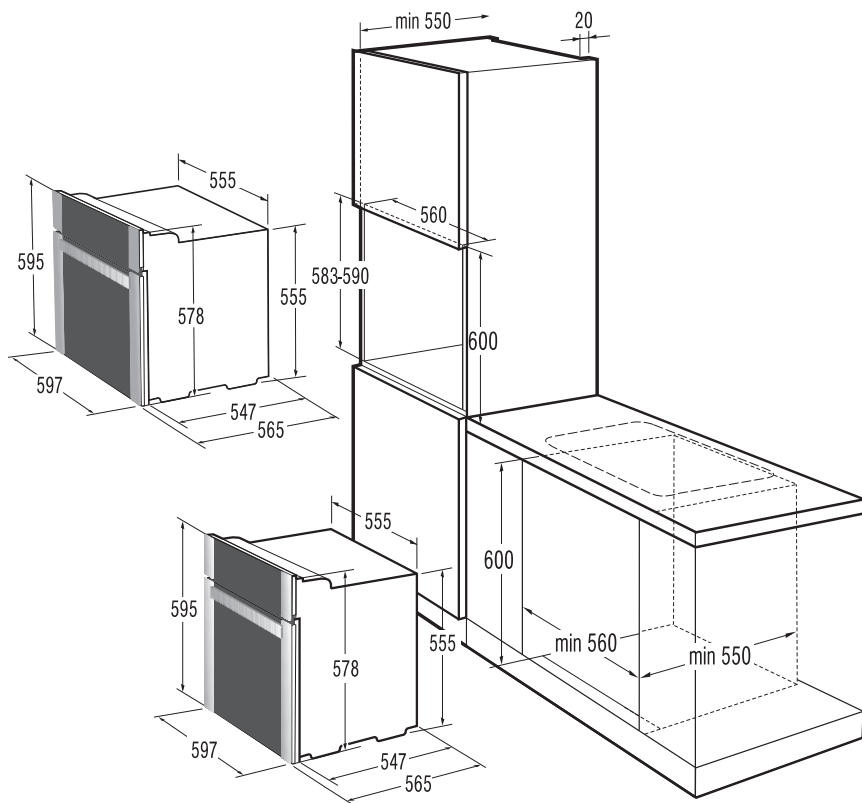

Electrical connection

The appliance may only be connected to the power mains by an authorized service technician or a registered electrician! Incorrect connection may result in damage to or destruction of respective parts of the appliance; in such cases, the warranty is void.

- Open the connection clip using a screwdriver, as indicated on the figure on the cover.
- The voltage (230V against N) in your home network must be checked by an expert using appropriate equipment!
- Before connection, make sure the voltage on the rating plate is consistent with the actual network voltage.
- The length of the power cord should be at least 1.5 meters; thus, the appliance can be connected before it is pushed to the wall.
- The length of the power cord should be adjusted in such way that in case of pulling load on the cable, the ground wire is strained later than the voltage wires.

Procedure

- Use a screwdriver to open the connection clamp cover at the back of the appliance. Use the screwdriver to release the two clips as indicated on the connection clamp cover.
- The power mains cable must be led through a tension release device that protects the cable from being pulled out.

Conduit colors

L1 = external conduit conveying voltage. Normally, the color is black or brown.

N = neutral

This conduit is normally blue.

Make sure the N-wire is correctly connected!

PE = protection (ground) conduit

This conduit is green and yellow.

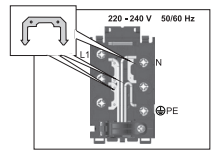
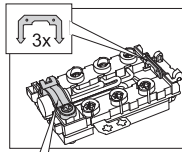
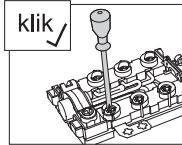
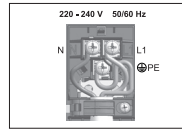
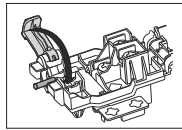
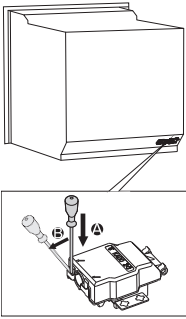

TECHNICAL CHARACTERISTICS

Rating plate

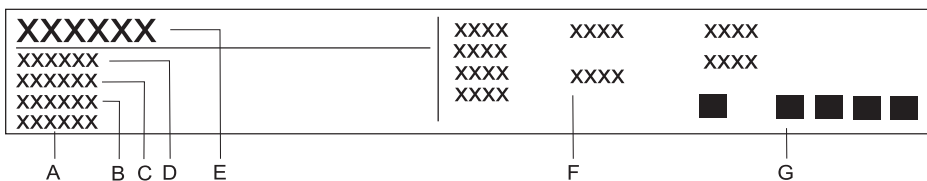

- A Serial number
- B Code
- C Model
- D Type
- E Trademark
- F Technical information
- G Compliance indications / symbols

WE RESERVE THE RIGHT TO MAKE ANY CHANGES THAT DO NOT AFFECT THE FUNCTIONALITY OF THE APPLIANCE.

Instructions for use of the appliance can also be found on our website at www.gorenje.com / < <http://www.gorenje.com> />

www.gorenje.com

