



# Instructions for Use

GB IE MT





# GLASS-CERAMIC BUILT-IN COOKING HOB

## Dear customer!



Glass-ceramic hob is intended for use in households.

Our products are packed in environment-friendly materials which can be recycled, disposed of, or destroyed without imposing any burden on the environment.

## Instructions for use

Instructions for use are intended for the user. They describe the appliance and its operation. The instructions apply to various types of appliances and may therefore include description of functions that may not be available on your appliance.

## Instructions for connection

The appliance must be connected in compliance with the instructions attached to it, as well as in compliance with relevant regulations and standards. The connection may only be performed by a qualified person.

## Rating plate

The rating plate indicating the basic information on the appliance is attached to the lower side of the hob.

## Fire risk protection

When the cooking hob is built-in, a kitchen furniture element that is higher than the hob can stand next to in on one side, provided the kitchen element on the other side of the hob is not higher than the hob level.

# TABLE

<b>IMPORTANT - READ BEFORE USING .....</b>	<b>5</b>
<b>THE APPLIANCE .....</b>	<b>5</b>
Safety precautions.....	5
Warnings.....	5
<b>APPLIANCE DESCRIPTION .....</b>	<b>7</b>
Cooking hob control elements (depending on the model) .....	8
<b>COOKING ZONES .....</b>	<b>9</b>
Before using the appliance for the first time.....	9
Important warnings.....	9
Cookware .....	10
Energy saving.....	10
<b>OPERATING THE COOKING ZONES .....</b>	<b>11</b>
Turning on the cooking hob.....	11
Turning on the cooking zones .....	11
Turning off the cooking zones .....	12
Turning off the cooking hob .....	12
Activating the child lock.....	12
Residual heat indicators.....	13
Power boost function.....	13
Cooking zone expansion (depending on the model) .....	15
Operation time limit.....	15
Temporary cooking progress suspension - STOP & GO (dependent on the model) .....	15
Programmable timer (depending on the model) .....	16
Special warnings and fault reports.....	18
<b>CLEANING AND MAINTENANCE.....</b>	<b>19</b>
Cleaning.....	19
<b>INSTALLATION .....</b>	<b>20</b>
Important warnings.....	20
Installing the foam gasket.....	21
Worktop cutout dimensions.....	21
<b>CONNECTING THE APPLIANCE TO .....</b>	<b>23</b>
<b>THE POWER MAINS .....</b>	<b>23</b>
Important warnings.....	23
Connection diagram .....	24
<b>TECHNICAL CHARACTERISTICS .....</b>	<b>25</b>
Rating plate.....	25

# IMPORTANT - READ BEFORE USING THE APPLIANCE

## Safety precautions

- This appliance can be used by children aged from 8 years and above and persons with reduced physical, sensory or mental capabilities or lack of experience and knowledge if they have been given supervision or instruction concerning use of the appliance in a safe way and understand the hazards involved. Children shall not play with the appliance. Cleaning and user maintenance shall not be made by children without supervision.
- **WARNING:** The appliance and its accessible parts become hot during use. Care should be taken to avoid touching heating elements. Children less than 8 years of age shall be kept away unless continuously supervised.
- **WARNING:** Danger of fire: do not store items on the cooking surfaces.
- **WARNING:** Unattended cooking on a hob with fat or oil can be dangerous and may result in fire. Never try to extinguish a fire with water, but switch off the appliance and then cover flame with a lid or a damp cloth.
- After use, switch off the hob element by its control and not rely on the pan detector.
- **WARNING:** If the surface is cracked, switch off the appliance to avoid the possibility of electric shock.
- Do not use steam cleaners or high-pressure cleaners to clean the cooking hob, as this may result in an electric shock.
- The appliance is not intended to be controlled by external timers or special control systems.

## Warnings

- The appliance may only be connected to the power mains by an authorized service technician or expert.
- Tampering with the appliance or non-professional repair thereof may result in risk of severe injury or damage to the product. Any repairs may only be carried out by an authorized service technician or expert.

- The appliance is intended solely for cooking. Do not use it for any other purpose, e.g. for room heating. Do not place empty cookware on the cooking zones.
- If another electrical appliance is connected to a AC power socket near the appliance, make sure the power cord does not come into contact with hot cooking zones.
- Do not store temperature-sensitive items underneath the appliance, such as cleaners or detergents, spray cans etc.
- Using the glass ceramic hob as a storage area may result in scratches or other damage to it. Never heat food in aluminium foil or in plastic containers on the cooking hob. Such foil or containers may melt which can result in a fire or damage to the cooking hob.
- Eventual mismatches in colour shades between different appliances or components within a single design line may occur due to various factors, such as different angles under which the appliances are observed, different coloured backgrounds, materials, and room illumination.



**The symbol on the product or on its packaging indicates that this product may not be treated as household waste. Instead it shall be handed over to the applicable collection point for the recycling of electrical and electronic equipment. By ensuring this product is disposed of correctly, you will help prevent potential negative consequences for the environment and human health, which could otherwise be caused by inappropriate waste handling of this product. For more detailed information about recycling of this product, please contact your local city office, your household waste disposal service or the shop where you purchased the product.**

# APPLIANCE DESCRIPTION

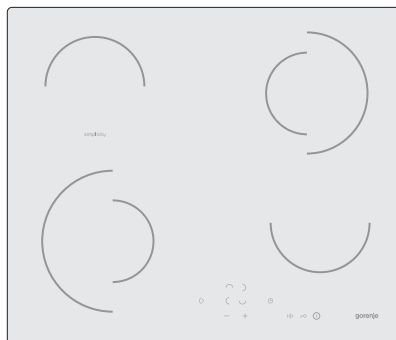
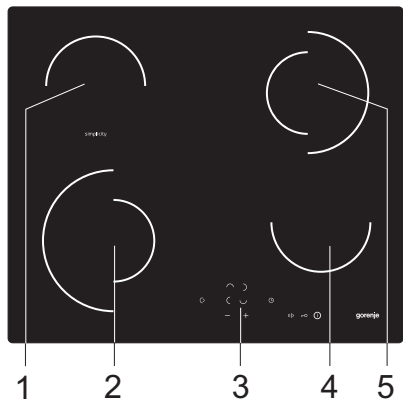

1. Cooking zone rear left
2. Cooking zone front left
3. Cooking hob control unit
4. Cooking zone front right
5. Cooking zone rear right

**Cooking hob control elements  
(depending on the model)**

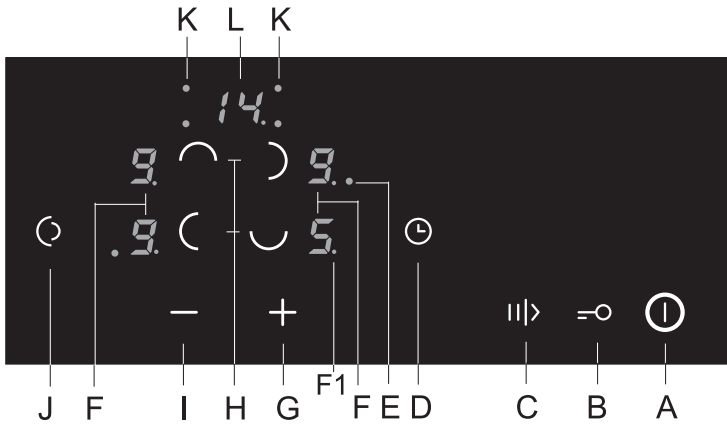

**Control sensor keys:**

- |  |  |
|--|--|
| <p><b>A</b> Cooking hob on/off sensor</p> <p><b>B</b> Child lock sensor</p> <p><b>B1</b> Child lock signal light</p> <p><b>C</b> Stop &amp; Go sensor (temporary cooking progress suspension sensor key)</p> <p><b>C1</b> Stop &amp; Go signal light</p> <p><b>D</b> Alarm or timer setting sensor</p> <p><b>E</b> Cooking zone expansion indicator light</p> <p><b>F</b> Power level / residual heat displays</p> | <p><b>F1</b> Active function decimal point</p> <p><b>G</b> Increase value / setting sensor</p> <p><b>H</b> Cooking zone selection sensor</p> <p><b>I</b> Decrease value / setting sensor</p> <p><b>J</b> Cooking zone expansion on/off sensor</p> <p><b>K</b> Switch-off timer indication light</p> <p><b>L</b> Time display</p> |
|--|--|



# COOKING ZONES

## Before using the appliance for the first time

Clean the glass-ceramic surface with a damp cloth and some manual dishwashing detergent. Do not use aggressive detergents such as abrasive cleaners that can scratch the surface, abrasive dishwashing sponges, or stain removers.

## Important warnings

- Do not turn on a cooking zone without a pan over it, and never use the cooking hob for room heating!
- Make sure the cooking zones and pan bottom are clean and dry, and that sufficient heat transmission is enabled between them, in order to prevent any damage to the heating surface.
- Any fat or oil left on the cooking ones may ignite. Therefore, be careful when using fat and oil to prepare food (e.g. French fries) and control the cooking process at all times.
- Do not place a damp pan or a steam-covered lid on the cooking zones, as moisture is detrimental to them.
- Do not leave a hot pan to cool down on the cooking zones, because moisture will be generated under it, causing corrosion.

### Important warnings regarding the glass ceramic hob

- Cooking zone reaches the selected power level or temperature very quickly; however, the area surrounding the cooking zones remains relatively cool.
- The hob is resistant to temperature changes.
- The hob is also impact-resistant. The pans may be placed onto the hob roughly without damaging the hob.
- Glass ceramic hobs should not be used as a worktop. Sharp objects can cause scratches.
- Preparing food in thin aluminum or plastic containers on hot cooking zones is not allowed. Do not place any plastic objects or aluminum foil on the glass ceramic hob.
- Never use a glass-ceramic hob that is cracked or broken. If an object falls on the hob with a sharp edge downwards, this could cause the hob / glass ceramic panel to break. The consequences are visible immediately, or only after a while. If any visible crack should appear, immediately disconnect the appliance from the power supply.
- If sugar or some sugar-laden food is spilt over a hot glass ceramic zone, immediately wipe the sugar off zone.

## Cookware

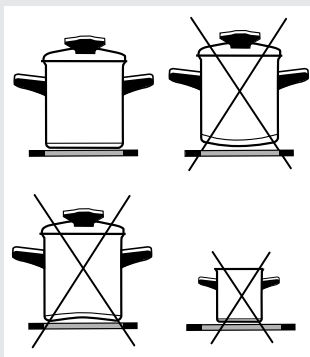

### Tips on using the cookware

Use high-quality cookware with a flat and stable bottom.

- Transmission of heat is best when the pan bottom and the cooking zone are of the same diameter, and the pan is placed on the middle of the cooking zone.
- When using a tempered glass (Pyrex) or porcelain cookware, please follow the cookware manufacturer's instructions.
- When using a pressure cooker, do not leave it unattended until the desired pressure is reached. The cooking zone should initially be set to the maximum power level; as the pressure rises, use the sensors to decrease the power level according to the pressure cooker manufacturer's instructions.
- Make sure there is always enough water, either in a pressure cooker or in any other piece of cookware, as using an empty pan on the cooking hob will result in overheating which will damage both the pan and the cooking zone.
- Tempered glass (Pyrex) cookware with a specially brushed bottom is suitable for use on cooking hobs if it fits the diameter of the cooking zone. Cookware with larger diameter may break due to thermal stress.
- When using any special or unconventional cookware, follow the cookware manufacturer's instructions.
- When a highly reflective pan (bright metal surface) or a pan with a thick bottom is used for cooking on a glass-ceramic hob, cooking time can be extended by several minutes (up to 10 minutes). If you wish to boil a larger quantity of food, it is recommended to use a container with a flat dark bottom.
- Do not use clay cookware, because it may leave scratches on the glass-ceramic hob.
- Pan bottom diameters should match the diameter of the cooking zone. If the pan is too small, some heat is wasted; furthermore, using a too small pan can damage the cooking zone.
- Whenever possible given the cooking process, use a lid.
- The pan should be appropriately sized given the quantity of food prepared. Preparing a small quantity of food in a large pan will cause a waste of energy.
- Dishes that take a long time to cook should be prepared in a pressure cooker.
- Various vegetables, potatoes, etc., can be cooked in a small quantity of water; however, the lid should be closed tightly. When the water is brought to boil, reduce the power level to a setting that maintains a temperature just above boiling point.

## Energy saving

# OPERATING THE COOKING ZONES

## Turning on the cooking hob

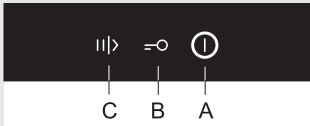

## Turning on the cooking zones

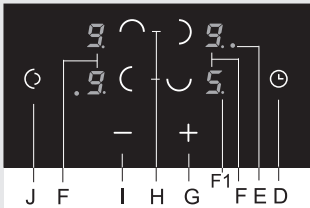

- The cooking hob is fitted with electronic sensor keys which are activated, respectively, when the indicated surface of a particular sensor is touched with a finger for at least one second.
- Activation of a sensor key is confirmed by a beep.
- Do not place any objects on the sensor key surface (this may trigger error reports).
- Make sure the sensor key surface is always clean.
- Touch the on/off sensor key (A) and hold it for at least one second. The cooking hob is activated; a "0" is displayed next to all power level displays (F), and a decimal point (F1) is flashing.

**⚠ Any subsequent setting must be carried out within the following 10 seconds; otherwise, the cooking hob will be automatically switched off again.**

- If the cooking hob was turned on with the on/off sensor key (A), the desired cooking zone may be activated in the following 10 seconds. To do this, touch the (H) sensor key. A decimal point (F1) will light up next to the power level display of the currently selected cooking zone.
- Touch the "+" sensor key (G) to set the power level 1-9. If the key "-" (I) is touched first, the setting 9 is selected immediately.

**⚠ When the "+" (G) or "-" (I) sensor key are pressed and held, the levels will automatically start decreasing or increasing. Power level can also be changed by touching these two sensor keys several times; in this case, the power level is changed stepwise.**

**⚠ Settings can only be made for one selected cooking zone at a time - the one indicated by the decimal point (F1).**

### Changing the cooking zone power level

- Select the cooking zone by pressing / touching the (H) sensor key. A decimal point (F1) will light up on the display of the selected cooking zone (F).
- Press the "+" (G) or "-" (I) sensor key to change the power level.

### Cooking zone reheating function

- The purpose of the reheating zone is to keep warm the food that is already cooked.

## Turning off the cooking zones

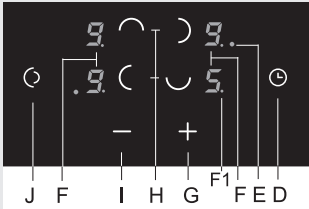

## Turning off the cooking hob

- Reheating function is activated by pressing the “-” (I) sensor key until the power level is set to 1 .
- Select the cooking zone by pressing the relevant sensor key (H). The decimal point (F1) next to the display for the selected cooking zone will light up.
- Press the “-” (I) sensor key to set the power level to “0”.
- Quick power off: the power level can be instantly set to “0” by pressing the “+” (G) sensor key and “-” (I) sensor key simultaneously.

## Activating the child lock

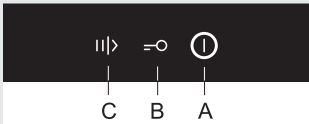

- The cooking hob may be turned off at any time by pressing the on/off sensor key (A).
- All indicators go off, except for the remaining, or residual, heat indicators which are lit on the displays for those cooking zones that are still hot.
- If the cooking zone is turned off before the end of the cooking process, the residual heat is used, which saves some power.

By activating the child lock, the operation and use of the cooking zones is prevented. This way, children will not be able to activate the cooking hob.

## Activating the child lock

- Activate the child lock by holding the (B) sensor key for approximately three seconds; the (B1) signal light will light up.
- Child lock can be activated when the cooking zone is operating.
- Child lock prevents activation of any sensor key, except for the main switch (A) and the child lock sensor key (B).

## Deactivating the child lock

- Child lock can be deactivated, or disengaged, by holding the (B) sensor key for three seconds. A beep will sound when the lock is disengaged and the signal light above the sensor key will go off.

## Residual heat indicators

As soon as a hot coking zone is switched off, or when the entire cooking hob is turned off, the following is displayed on the display of each hot cooking zone:

- “H” if the cooking zone is still hot;
- “h” if the cooking zone is cooling down and is warm to touch.

The duration of this display is calculated given the power level and depends on how long the cooking zone has been activated. When the “H” or “h” sign goes off, the cooking zone may in some cases (power failure, a hot pan left on the cooking zone) still be hot. Be careful, as there is a risk of burning. If a power failure has occurred when the cooking zones were hot, the indicator “H” or “h” will flash. This is to warn you that the cooking zone may still be hot, but not necessarily, depending on how long the power supply was out of order.



**The appliance has been tested at the factory. This test includes heating up all cooking and warming zones; therefore, “H” symbol may flash on the display for a while after the appliance is first connected to the power mains.**

## Power boost function

When this function is activated, the cooking zone will operate at the highest possible level for a certain period of time, depending on the selected power level; after this, the cooking zone will automatically switch to the initially selected level and continue operating. The power boost function may be activated for each cooking zone, for any power level, except for power level “9”, as in this case the cooking zone is constantly operating at full power.

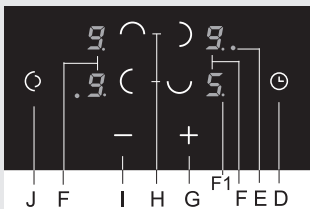

### Activating the power boost function

- Set the power level to 9.
- Press the “+” (G) sensor key. Indications “A” and “9” are shown on the display alternately.
- Reduce the power level to the desired level at which the cooking is to continue.

The symbol “A” and the selected power level will be indicated alternately on the display. When the power boost function has expired, the cooking zone will switch automatically to the selected level which is then indicated permanently on the display.



**If the power level is changed during the power boost on a particular cooking zone, the power boost function is immediately deactivated.**

**The power boost function is appropriate for the following:**

- Food that is cold at the beginning of preparation is quickly warmed up, and then left to cook for a longer period of time; with the power boost function, this can be done without constantly controlling the cooking process (e.g. beef stew).

**The power boost function is not recommended for the following:**

- Food that is fried, broiled, or stewed and must be turned frequently, adding liquid, or stirring; dumplings or pasta with a lot of liquid; food that requires boiling for longer period of time in a pressure-cooker.

Dish/cooking mode	quantity	power level	cooking duration (min)
Soup/reheating	0,5 - 1 lit	A7 - 8	4 - 7
milk/reheating	0,2 - 0,4 lit	A1 - 2	4 - 7
rice/simmering	125 - 250 g approx. 300ml - 600ml water	A2 - 3	20 - 25
cooked jacket potatoes	750g - 1,5 kg approx. 600ml - 900ml water	A5 - 6	25 - 38
fresh vegetables/ boiling	0,5 - 1 kg approx. 400ml - 600ml water	A4 - 5	18 - 25

- The table below lists the examples of some dishes for which rapid heating is appropriate.
- The values indicated are approximate and depend on other parameters (e.g. type and quality of cookware, quantity of additional water, etc.).
- Minor quantities are indicated for smaller cooking zones and major quantities apply to larger cooking zones.
- **Cook in pots covered with lids on the two smaller cooking zones back left, front right, or on the double cooking zone front left.**

## Cooking zone expansion (depending on the model)

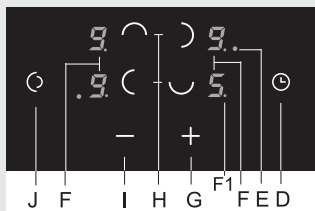

## Activating the cooking zone expansion

- For a selected cooking zone (a decimal point is lit next to the display for the currently selected zone), an additional heating coil can be activated by pressing the (J) sensor key. The signal light (E) next to the display will light up.
- Select the cooking zone for both heating coils.
- If a cooking zone also features a third heating coil, this can also be engaged by pressing the (J) sensor key once again.

## Deactivating the additional heating coil

- Select the cooking zone (a decimal point is lit next to the display for the currently selected zone).
- Additional heating coil may be deactivated by pressing the (J) sensor key for the selected cooking zone several times.

## Operation time limit

For improved safety, your cooking hob is fitted with a device that limits the duration of the cooking hob operation for each cooking zone respectively. The duration of operation is measured from the last change made to the power level settings for a particular cooking zone. If the power level is not changed for a while, the cooking zone will automatically be switched off after a certain period of time which depends on the power level (the higher the power level, the shorter the duration - see table below).

Power level	u	1	2	3	4	5	6	7	8	9
Maximum operation time in hours	6	6	6	5	5	4	1,5	1,5	1,5	1,5

## Temporary cooking progress suspension - STOP & GO (depending on the model)

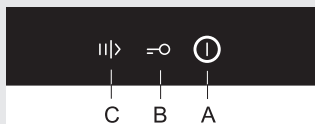

The STOP & GO function enables you to temporarily suspend, or pause the cooking progress (urgent other tasks), while keeping all the settings.

## Engaging the STOP & GO function

- Cooking is temporarily suspended by touching the STOP & GO (C) sensor key.
- A signal light (C1) will light up above the sensor key.
- All settings are frozen, and the cooking zones do not operate. The letters S, t, O, and P are indicated alternately on the display.

## Resuming the cooking progress

- The cooking hob will continue to operate when the STOP & GO (C) sensor key is pressed again.
- Signal light (C1) goes off.



**If the STOP & GO function is not deactivated in 10 minutes, the entire cooking hob will be switched off automatically.**

## Programmable timer (depending on the model)

### The appliance offers two timer functions:

- A** alarm function – countdown without the switch-off option
- B** switch-off function – countdown with the switch-off option for respective cooking zones.

### A Warning function- countdown without switching off the cooking zone

The timer warns you that the time set has elapsed, but does not turn off the cooking zone. The alarm timer can be set when the cooking hob is on.

- Press the timer sensor key (D) to activate the timer. “00” is displayed on the timer display (L) and the decimal point (F1) is lit.
- Press the “+” (G) and “-” (I) sensor keys to set the time in the range from 1 to 99 minutes.
- After the set time has elapsed, an alarm will sound, but the cooking zone will not be turned off.
- Acknowledge and turn off the alarm by pressing any sensor key; if this is not done, the alarm will stop after a certain period of time.
- Alarm will remain active also after the hob is switched off with button (A).

### B Timer with the option to turn off the cooking zone

The switch-off timer facilitates the cooking process by allowing you to set the cooking time for a particular cooking zone. In order to set the switch-off timer, the power level must already have been set (see section “Turning on the cooking zones”).

- Press the timer sensor key (D) to activate the timer. “00” is displayed on the timer display (L) and the decimal point (F1) is lit. When the (D) sensor key is pressed again, the (K) point indicating the selected cooking zone, starts flashing.
- As long as the decimal point is lit, sensor keys “+” (G) and “-” (I) can be used to set the time in the range from 1 to 99 minutes. IF the sensor key is pressed and held, the rate at which the timer setting is changing will be increased after a while.
- When the value was set, the countdown starts. The corresponding point (K) is still flashing, indicating the selected cooking field.

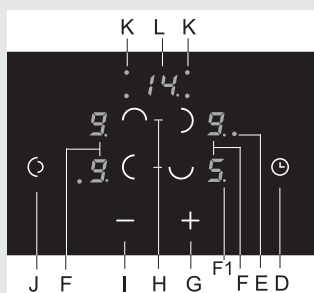



**⚠** **Cooking time can be set for each cooking zone independently. If several timers have been programmed, the time that is closest to zero will always be displayed. This is indicated by a flashing signal light (L) which indicates the cooking field.**

### Changing the timer setting

- Timer setting can be changed any time during operation.
- Press the timer sensor key (D) to display the remaining time for the selected cooking field. The corresponding signal light (K) will flash.
- Press the “+” (G) or “-” (I) sensor key to set the new cooking time.

### Checking the remaining cooking time

If several timers are set, the remaining cooking time can be displayed by touching the (D) sensor key.

### Switching off the timer

After the set time has elapsed, an alarm will sound and the cooking zone will be turned off. The value “00” flashes on the timer display. Switch off the alarm by pressing any sensor key; if this is not done, the alarm will go off after a certain period of time.

### To deactivate the timer before the set time has elapsed:

- Select the desired timer display (see section Changing the timer setting) – the set time and the corresponding dot that indicates the cooking field will flash.
- Press the “-” (I) sensor key to set the value to “00”, or press the “+” (G) and “-” (I) sensor key simultaneously, to reset the value to zero immediately.

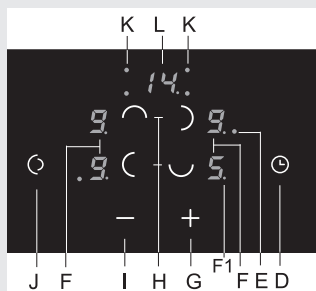

## Special warnings and fault reports

- If all power levels are set to "00", the cooking hob will be turned off automatically after 10 seconds.
- If any of the keys is activated for more than 10 seconds, the cooking hob will be turned off, an alarm will sound, and the symbol "F" will flash on the display.
- If several keys are covered by an object or if boiled-over liquid is spilt over the surface of the sensor keys, the cooking hob will automatically go off after a certain period of time.
- If the keys do not respond, disconnect the cooking field from the power supply network for a few minutes (remove the fuse or trip the main switch); then, reconnect the hob to the power mains and reengage the main switch.



**In case of an operation failure or if the fault / error indication does not disappear, disconnect the cooking hob from the power mains for a few minutes (undo the fuse or turn of the main switch); then, reconnect it to the power mains and turn on the main switch key.**

If the problems persist, call a service technician.

# CLEANING AND MAINTENANCE

## Cleaning

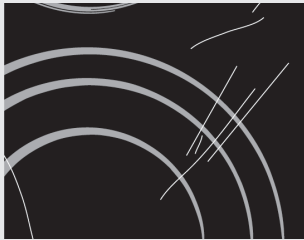

Figure 1

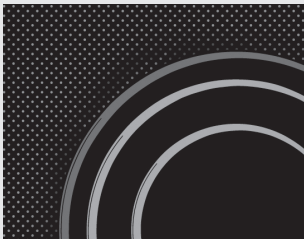

Figure 2



Figure 3



Figure 4

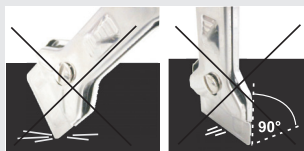

After each use of the **glass-ceramic hob**, wait for it to **cool down** and clean it; otherwise, even the smallest food residue will be burnt onto the hot surface next time you use the appliance. **For regular cleaning and maintenance of the glass-ceramic surface, use special conditioning agents** which form a protective layer on the surface, shielding it from dirt. Before each use, wipe any dust or other particles from the hob surface and pan bottom as these could scratch the surface (Figure 1).

**Careful:** steel wool, abrasive sponges, and abrasive detergents can scratch the hob surface. Glass ceramic surface can also be damaged by aggressive sprays and inappropriate or insufficiently shaken (mixed) liquid cleaning agents (Figure 1 and Figure 2).

**Signage** may be worn when using aggressive or abrasive cleaners or cookware with damaged bottom (figure 2).

**Light stains** can be removed by a damp soft cloth; then, wipe the surface dry (Figure 3).

**Water stains** can be removed using a mild solution of vinegar; however, do not use this solution to clean the frame (only with some models, as it may become dull. Do not use aggressive sprays or decalcification agents (Figure 3).

**Heavier stains** can be removed using special agents and utensils for cleaning the glass-ceramic hobs. When using these products, follow the instructions provided by their respective manufacturers.

**Make sure any residues of cleaning agents are thoroughly removed, as they could damage the glass-ceramic hob when the cooking zones heat up** (Figure 3).

Remove stubborn and burnt residues with a scraper (figure 4).

Be careful when handling the scraper to prevent injury.

**!** Only use the scraper when dirt cannot be removed with a wet cloth or special cleaners for glass ceramic surfaces.

Hold the scraper at the **correct angle** (45° to 60°). **Gently press the scraper** against the glass and slide it over the signage to remove the dirt. Make sure the plastic handle of the scraper (in some models) does not come into contact with a hot cooking zone.

**!** Do not press the scraper perpendicularly against the glass and do not scratch the hob surface with its tip or blade.

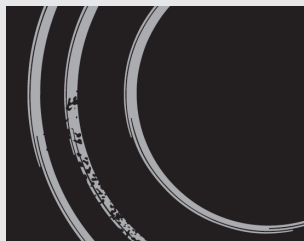

Figure 5

Sugar and sugar-laden food may permanently damage the glass-ceramic surface (Figure 5); therefore, they should be removed from the glass-ceramic surface as soon as possible, although the cooking zone may still be hot (Figure 4). **Any change in the color of the glass-ceramic surface** does not affect its operation or the stability of the surface. Such discolorations are mostly a result of burnt food residues or use of cookware made of materials such as aluminum or copper; these stains are difficult to remove.

**Warning:** All damage described above predominantly relates to the aesthetics, i.e. appearance of the appliance and do not affect its functionality directly. Such errors cannot be the subject of a warranty claim.

## INSTALLATION

### Important warnings

- Installation of the appliance into a kitchen worktop and its connection to the power mains may only be performed by an adequately qualified technician.
- Veneer or other finish of the piece of kitchen furniture into which the hob is to be built in should be treated with heat resistant glue (100°C); otherwise, the worktop finish may be discolored or deformed.
- Cooking hob is dimensioned to be built into the worktop over a piece of kitchen furniture, with a width of 600 mm or more.
- After installation, the front two fastening elements should be freely accessible from below.
- Hanging, or wall-mounted kitchen elements should be installed high enough not to interfere with the work process.
- The distance between the cooking hob and the kitchen hood should be no less than indicated in the instructions for kitchen hood installation. The minimum distance is 650 mm.
- The distance between the appliance edge and the adjacent tall kitchen furniture element should amount to no less than 40 mm.
- Use of massive wood decoration plates or boards on the worktops behind the cooking hob is permitted, if the minimum distance remains the same as indicated in the installation drawings.
- Minimum distance between the built-in cooking hob and the rear wall is indicated on the installation drawing.

## Installing the foam gasket

Before inserting the appliance into the opening in the kitchen worktop, the supplied foam gasket must be attached to the lower side of the glass ceramic (glass) cooking hob (see figure above). **Do not install the appliance without the foam gasket!**

### The gasket should be attached to the appliance in the following way:

- Remove the protective film from the gasket.
- Then, attach the gasket to the lower side of the glass, approximately 2-3 millimetres from the edge (as shown in the figure). The gasket must be attached along the entire length of the glass edge and should not overlap at the corners.
- When installing the gasket, make sure that the glass does not come into contact with any sharp objects.

### NOTE!

On some appliances the gasket is already installed!

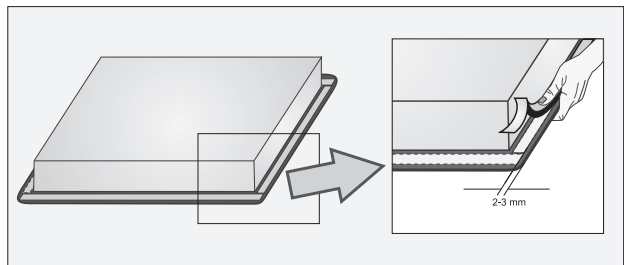

## Worktop cutout dimensions

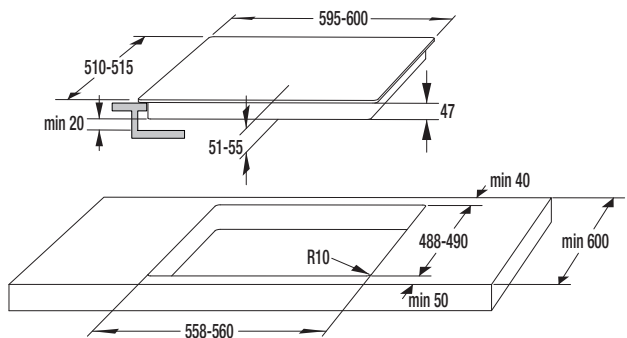

- Cooking hobs can be installed into worktops that are 30 to 50 mm thick.
- The kitchen furniture element underneath the hob should not be fitted with a drawer. If the kitchen furniture element as a horizontal partition wall, it should

be installed no less than 60 millimeters from the lower surface of the worktop. The space between the partition wall and the hob must be empty; no objects should be placed into that gap.

- On the furniture back wall there should be a cutout with width of at least 175 mm along the entire width of the furniture element.
- Only type EVP4...EVP2..., ovens fitted with a cooling fan may be installed underneath this cooking hob.

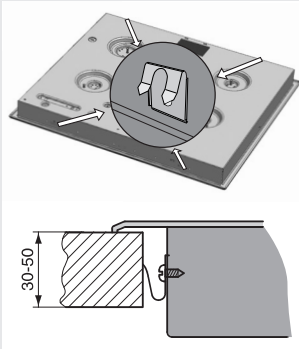

### Installation procedure

- The worktop should be installed completely horizontally.
- The cutoff surfaces should be appropriately protected.
- Attach the fastening elements (4x - SVK6...600 mm; 6x - SVK7...750 mm; 6x - SVK8...850 mm) with the supplied screws (4x - SVK6...600 mm; 6x - SVK7...750 mm; 6x - SVK8...850 mm) to the left and right wall of the cooking hob and the worktop cutoff.
- Connect the cooking hob to the power mains (see instructions for connecting a cooking hob on a power network).
- Insert the cooking hob into the cutoff and press it heavily from above against the worktop.
- For screwing down the fixing clip it is not allowed to use screws longer than 6,5 mm.

# CONNECTING THE APPLIANCE TO THE POWER MAINS

## Important warnings

- The appliance may only be connected by an authorized skilled technician.
- Electric system protection should comply with all relevant regulations.
- The connection clips can be accessed when the connection clip covers are opened / removed.
- Before connecting the appliance, make sure the voltage indicated on the rating plate is consistent with the voltage in your home circuit.
- The rating plate with basic information is attached on the lower side of the hob.
- The electric circuit should also include an omnipolar switch that will separate the appliance from the mains, if required, with at least 3 mm of distance between contacts. Suitable devices include fuses, current protection switches, etc.
- The connection should be selected according to the installation possibilities with regard to current and fuses.
- Given the protection from the risk of fire, appliances of this type may be installed in a worktop next to a piece of kitchen furniture that is taller than the appliance (when installed); however, in this case, a kitchen furniture not higher than the cooking hob must be installed on the other side, adjacent to the appliance.
- The current conducting and isolated parts must be protected from any possibility of direct contact.

## ATTENTION!

- Before any manipulation with the appliance (other than its regular use), disconnect it from the power mains. The appliance should be connected according to the relevant scheme (diagram), subject to the network voltage. Connect the earth (PE) wire to the clip indicated with the earth /ground symbol.
- The mains cord must be fed through the fastening clip / strain release device which protects it from being pulled out accidentally.
- After connecting the appliance, turn on all cookers for approximately three minutes to check their operation.

## Connection diagram

" The appliances are suitable for photovoltaic electrical power under the condition that electrical voltage will be 220VAC - 240VAC with semi tonic frequency 50Hz in order the appliance to operate properly (alternative a generator can be used with the same technical characteristic)."

- Incorrect connection may destroy parts of the appliance, making the warranty void.
- Before connecting the appliance, make sure the voltage indicated on the rating plate is consistent with the voltage in your home network. Connection voltage (230 V through N) should be checked by a qualified technician using a corresponding measuring device!
- Connection cable on the back of the appliance should be led in such way that it does not touch the appliance back wall, as this part will get very hot during operation.

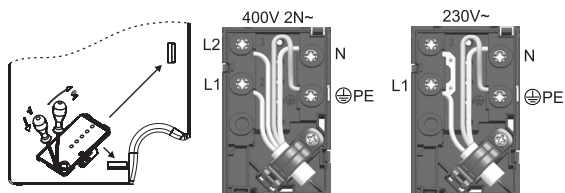

### NOTE:

Connection bridges are already installed on their respective places on the clip. Screws of the connection terminals are open, which means they do not have to be unfastened or unscrewed any further. When fastening the screws, you may hear a slight 'click', which means that the screws should be fastened / screwed in completely.

The following can be used for connection:

- Type H05 RR-F 4x1.5 rubber connection cables with a green-yellow protective wire,
- Type H05 VV-F 4x1,5 PCV insulated connection cables with yellow-green protective wire, or other equivalent or superior grade cables.



# TECHNICAL CHARACTERISTICS

## Rating plate

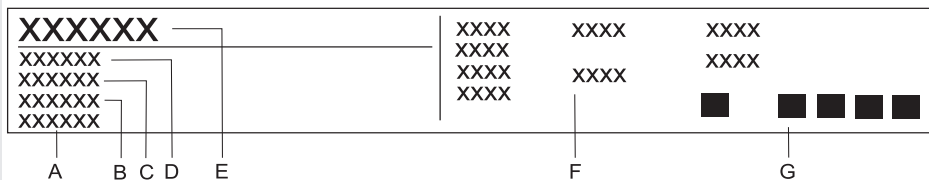

- A Serial number
- B Code
- C Model
- D Type
- E Trademark
- F Technical information
- G Compliance indications / symbols

WE RESERVE THE RIGHT TO MAKE ANY CHANGES  
THAT DO NOT AFFECT THE FUNCTIONALITY OF THE  
APPLIANCE.

Instructions for use of the appliance can also be found on  
our website at  
[www.gorenje.com](http://www.gorenje.com) / < <http://www.gorenje.com> />





www.gorenje.com

simplicity  
COLLECTION



0002-649

ECT6SY2W

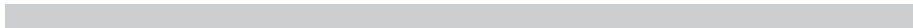

SVK6CS



436556

(09-17) en