









STEP 1

CHECK THE SYMBOLS ON THE LAUNDRY

 Table of other symbols can be found in the full instructions for use.

MACHINE WASHING ALLOWED

Max. washing temperature 95°C  	Max. washing temperature 60°C  	Max. washing temperature 40°C  	Max. washing temperature 30°C  
--	--	--	--



MACHINE WASHING NOT ALLOWED

Hand wash only 	Do not wash 
---	--

STEP 2

PREPARING THE LAUNDRY

STEP 3

SORT THE LAUNDRY BY TYPE (more in the program table below).

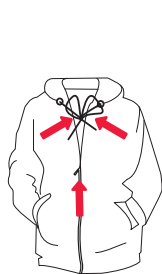

1 Close the zippers and tie any strings.

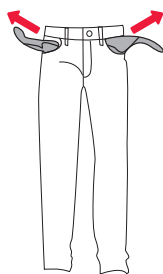

2 Turn the pockets inside out.

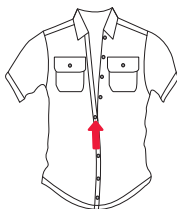



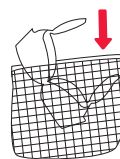



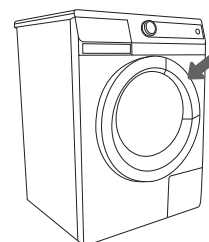







3 Close the buttons.



4 Place delicate items in a washing bag.



5 Open the washing machine door by pulling the handle towards you.

Program	Laundry	Program	Laundry
Cotton 	Non-delicate cotton and linen laundry • towels, underwear, T-shirts, terry towelling etc.	Anti mites 	For washing bed linen, pillows, and larger pieces of laundry. Follow the instructions for washing and maintenance.
Mix/Synthetics 	Coloured laundry (of like colours), • clothes made of a combination of various fabrics, e.g. polyester, polyamide etc.	Baby clothes 	For washing garments which require special care, like baby clothes and clothes for people with extremely sensitive skin. We recommend you turn the garments inside out, to be able to wash thoroughly the dried skin and remains of detergents and washing agents.
Hand wash/Delicate 	Delicate laundry made of linen, silk, wool, or viscose silk • (dresses, skirts, blouses etc.) and curtains Very gentle program	Sportswear (Active) 	Slightly soiled sportswear made of cotton, microfibres, synthetic fibres etc. • at lower spinning rates
Wool 	Woolens and wool mixtures • labelled as washer-safe	Anti allergy Cotton 	• For washing garments which require special care, like clothes for people with extremely sensitive skin.
Quick wash 17' 	Lightly soiled laundry; refreshment of laundry. • Saves time and power.	Rinse 	• For rinsing of the laundry without spinning between the rinsing cycles, with a final spinning cycle.
Perfect black 	Washing dark laundry, using special-purpose detergents • for washing at low temperatures, with gentle tumbling.	Softening 	• For softening, starching, or impregnating the washed laundry. Also useful as a short rinse with a final spinning cycle.
Silent wash 	Mixed coloured laundry made of various permanent fabrics, • with gentle tumbling and shorter washing time.	Spinning/Pumping 	• For spinning, • To pump the water from the drum and tub, decrease the spinning rate to "Ø".

STEP 4

MOST COMMONLY USED PROGRAMS

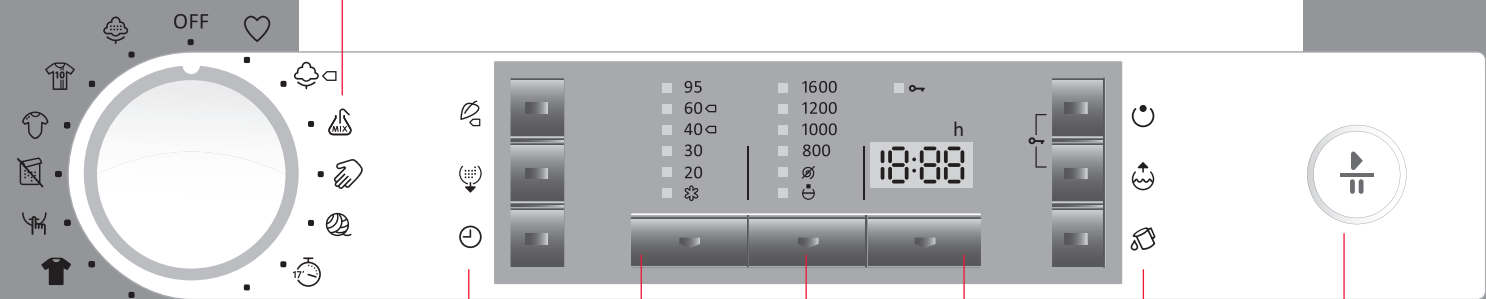

1 CHOOSE A PROGRAM OR SWITCH ON/OFF THE WASHING MACHINE

2 SET THE WASHING MODE

3 SET THE WASHING TEMPERATURE

4 SET THE SPINNING RATE

5 SET THE WASHING CYCLE DELAY TIME

6 SET ADDITIONAL/EXTRA FUNCTIONS

7 PRESS FOR START/PAUSE OF THE WASHING CYCLE

 **Eco care**
(Save power, longer washing time, less water used)

 **Allergy care**
(For laundry used by persons sensitive to detergents)

 **Time care**
(Save time, shorter times, more water)

Changing the temperature on the selected program.

From preset temperature on the selected program to cold wash.

Changing the spinning rate on the selected program.

The last setting is "stop pump" - the laundry remains soaked in water from the last rinse.

Use this function to start the washing cycle after a certain amount of time has elapsed (from 30 minutes to 24 hours), after pressing the START/PAUSE key.

 **PREWASH** for heavily soiled laundry.

 **EXTRA WATER** washing with an extra amount of water.

 **STERILTUB** removes impurities from the washing machine (only on Cotton 95°C (Normal care) without any laundry in the drum).

 **CHILD LOCK** a safety feature. To activate the child lock, press the keys simultaneously and hold them for at least three seconds. Use the same procedure to deactivate the lock.

STEP 5

END OF WASHING PROGRAM

 Acoustic signal will indicate the end of the washing process; the display will read END.



1 Open the washing machine door by pulling the handle towards you.



2 Take the laundry from the drum.



3 Close the washing machine door.

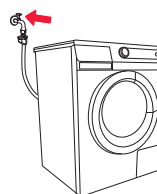

4 Shut off the water supply tap.



5 Switch off the appliance (rotate the program selector dial to the »OFF« position).

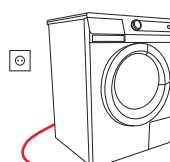

6 Unplug the power cord from the outlet.

CLEANING THE DISPENSER TRAY

! Before cleaning, unplug the washing machine from the power mains.

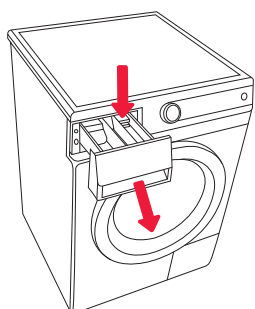

1 To remove the dispenser tray from the housing, press the small lever.

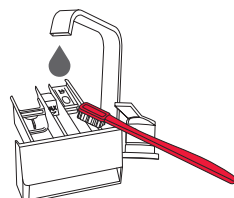

2 Use a brush to clean the dispenser tray under running water and dry it thoroughly.

Also remove any detergent residue from the bottom of the housing.

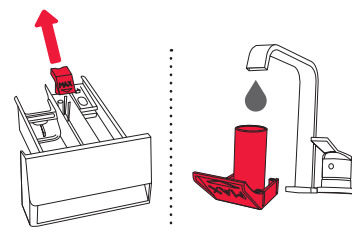

3 If required, remove and clean the plug cap.

Clean the plug cap under running water and replace it.

CLEANING THE WASHING MACHINE RINSING AREA

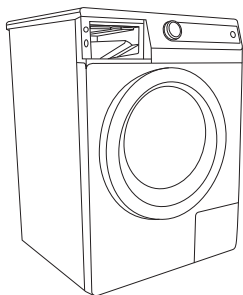

1 Before replacing the dispenser tray, also clean the rinsing area.

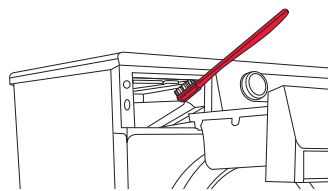

2 In particular, clean the nozzles on the upper side of the rinsing chamber with a brush.

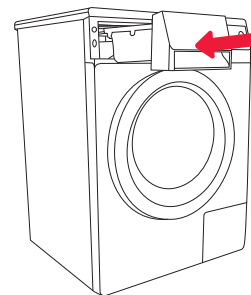

3 Replace the dispenser tray.

INLET HOSE NET FILTER, AND RUBBER DOOR GASKET

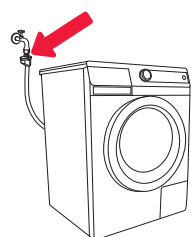

1 Remove the net filter from the inlet hose.

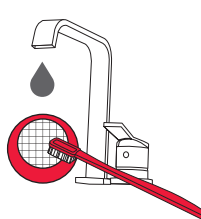

2 Clean the net filter several times under running water.

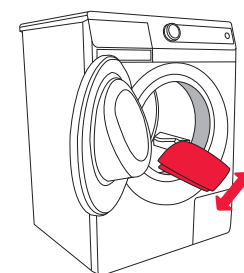

3 After each wash, wipe the rubber door gasket.



en (12-14)
PSTO CLAS VITA

CLEANING THE FILTER

! The filter must be occasionally replaced, especially after washing very old and fleecy or woolly laundry.

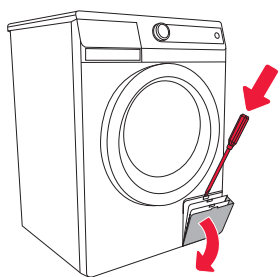

1 Open the filter lid using flat screwdriver or similar tool.

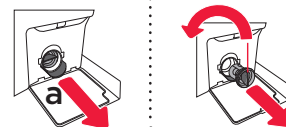

2 Remove the water outlet funnel (a) before cleaning the filter.

Rotate the filter slowly in the counter-clockwise direction (b). Remove the filter to allow the water to slowly drain.

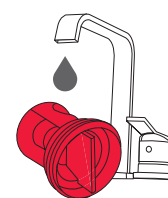

3 Clean the filter under running water and replace it.

Fasten the filter by rotating it in the clockwise direction.

TIPS

FOR WASHING

FOR ECONOMIC USE OF THE WASHING MACHINE

WASHING TIPS

- Wash new coloured garments separately the first time.
- Wash heavily soiled laundry in smaller amounts, with more detergent or a pre-wash cycle.
- Treat stubborn stains with a special stain removal agent before the wash.
- If you often wash laundry at low temperatures and with liquid detergents, bacteria may spawn which can cause an odour. We recommend using the self-cleaning program.
- Before putting folded laundry into the drum, loosen every item.
- Only use detergents for machine washing.
- Add the powder or liquid detergents as instructed by the manufacturer, according to the washing temperature and selected washing program.

TIPS FOR ECONOMICAL USE

- We recommend avoiding washing very small amounts of laundry as this will lead to excessive use of energy and poorer performance.
- With slightly soiled laundry, we recommend a program without pre-wash, use of shorter programs (e.g. Time Care) and a lower washing temperature.
- If water hardness exceeds 14°dH, water softener should be used.
- Use of chlorine-based bleaches is not recommended.
- Do not place the detergent in compact balls into the dispenser tray.
- When using highly viscous care products, we recommend thinning them with water.

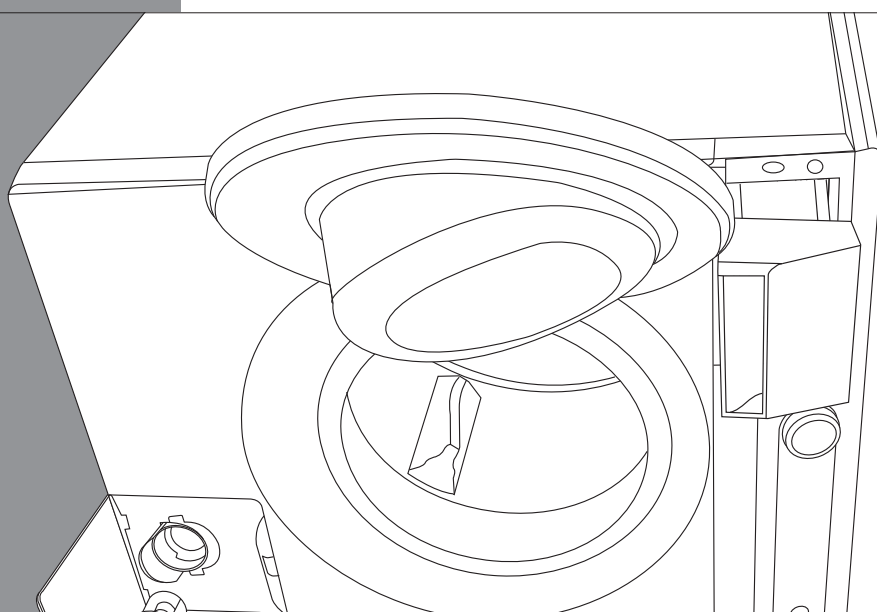

For detailed instructions please read the extended manual.

**QUICK INSTRUCTIONS
HOW TO USE THE
WASHING MACHINE**