

GB Instructions for use

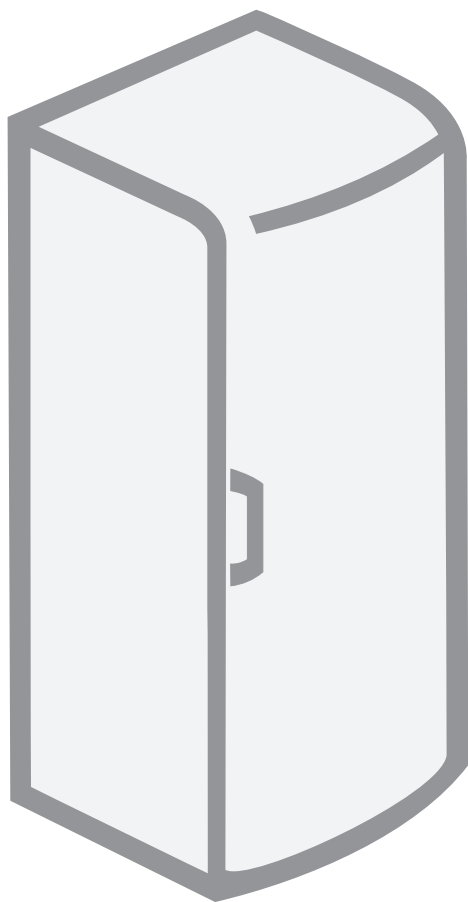

Upright Freezer

We thank you for the confidence you have shown by purchasing our appliance.
We wish you a lot of pleasure using the appliance.

The appliance is intended solely for household use.

The upright freezer is intended for use in households, for freezing fresh food and long-term storage of frozen food (up to one year, depending on the type of food).

Important warnings	3
A few tips on how to save power with your refrigerator-freezer combo	9
Appliance description	10
Installation and connection	12
Changing the door opening direction	14
Operating the appliance.....	17
Freezing fresh food and storing frozen food	23
Defrosting the appliance.....	26
Cleaning the appliance	27
Troubleshooting	28
Information on appliance noise	29

Important warnings

BEFORE USING THE APPLIANCE FOR THE FIRST TIME

The appliance is manufactured in compliance with the effective safety standards. However, it can be used by children aged from 8 years and above and persons with reduced physical, sensory or mental capabilities or lack of experience and knowledge if they have been given supervision or instruction concerning use of the appliance in a safe way and understand the hazards involved.

Before connecting the appliance, carefully read the instructions for use which describe the appliance and its correct and safe use. The instructions apply to several types / models; therefore, they may include descriptions of settings and equipment that may not be available in your refrigerator. The instructions also apply to the NO FROST version of the freezer, featuring a built-in fan and automatic defrosting.

Remove the packaging that is intended for protecting the appliance or its respective parts during transport.

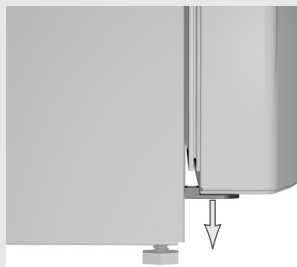

Spacers are fitted in the corners of the doors; these should be removed and the plugs attached (only with some models) should be inserted into the openings.



WARNING! Risk of fire/flammable materials.

The appliance must be connected to the power mains and grounded in compliance with the effective standards and regulations.

WARNING! Do not locate multiple portable socket-outlets or portable power supplies at the rear of the appliance.

Before cleaning the appliance, unplug it from the power mains (unplug the power cord from the wall outlet).

WARNING! If the supply cord is damaged, it must be replaced by the manufacturer, its service agent or similarly qualified persons in order to avoid a hazard.

WARNING! When positioning the appliance, ensure the supply cord is not trapped or damaged.

If LED lighting does not work, call a service technician. Do not attempt a repair of the LED lighting yourself, as there is danger of contact with high voltage!



WARNING! Do not use electrical appliances inside the food storage compartments of the appliance, unless they are of the type recommended by the manufacturer.



WARNING! Do not use mechanical devices or other means to accelerate the defrosting process, other than those recommended by the manufacturer.



WARNING! To avoid any hazard resulting from poor stability of the appliance, make sure it is installed as instructed.

Danger of frostbite

Never put frozen food in your mouth and avoid touching frozen food as this may cause frostnip or frostbite.

Safety of children and vulnerable persons

The appliance is not intended for use by persons (including children) with reduced physical, sensory or mental capabilities, or lack of experience and knowledge, unless they have been given supervision or instruction concerning use of the appliance by a person responsible for their safety.

Children should be supervised to ensure that they do not play with the appliance.

Cleaning and user maintenance shall not be made by children without supervision.

Cleaning and user maintenance shall not be made by children without supervision.

Remove the packaging intended to protect the appliance or particular parts during transport and keep it outside the reach of children.

It presents danger of injury or suffocation.

For European markets only

This appliance can be used by children aged from 8 years and above and persons with reduced physical, sensory or mental capabilities or lack of experience and knowledge if they have been given supervision or instruction concerning use of the appliance in a safe way and understand the hazards involved.

Children shall not play with the appliance.

Cleaning and user maintenance shall not be made by children without supervision.

Children aged from 3 to 8 years are allowed to load and unload refrigerating appliances.

Warning regarding the refrigerant

The appliance contains a small amount of an environmentally friendly yet flammable gas R600a. Make sure that no parts of the cooling system are damaged. A gas leak is not hazardous to the environment, but it could cause eye injury or fire.

In case of a gas leak, ventilate the room thoroughly, disconnect the appliance from the power mains, and call a service technician.

**IMPORTANT
INFORMATION ON THE
USE OF APPLIANCE**

WARNING! This appliance is intended to be used in household and similar applications such as:

- staff kitchen areas in shops, offices and other working environments;
- farm houses and by clients in hotels, motels and other residential type environments;
- bed and breakfast type environments;
- catering and similar non-retail applications.



WARNING! Keep ventilation openings, in the appliance enclosure or in the built-in structure, clear of obstruction.

The appliance may not be used outdoors and it may not be exposed to rain.

Do not store explosive substances such as aerosol cans with a flammable propellant in this appliance.

If the appliance will be out of use for an extended period of time, switch it off using the relevant button, and unplug it from the power mains. Empty the appliance, defrost it, clean it, and leave the door ajar.

In case of an error or power supply failure, do not open the freezer compartment unless the freezer has not operated for over 16 hours. After this period, use the frozen food or provide sufficient cooling (e.g. a replacement appliance).

Technical information on the appliance

Rating plate can be found in the appliance interior. It indicates data on voltage, gross and net volume, type and amount of refrigerant, and information on the climate classes.

If the language on the rating plate is not the language of your choice or the language of your country, replace it with the one supplied.

Packaging is made of environmentally friendly materials that can be recycled, disposed of, or destroyed without any hazard to the environment.



Removing an obsolete appliance

To protect the environment, take the obsolete appliance to an authorized home appliance collection centre.

Before doing so, do the following:

- disconnect the appliance from the power mains;
- do not allow children to play with the appliance.



WARNING! Do not damage the refrigerant circuit.
This will also prevent pollution.



The symbol on the product or its packaging indicates that the product should not be treated as normal household waste. The product should be taken to an authorized collection centre for waste electric and electronic equipment processing. Correct disposal of the product will help prevent any negative effects on the environment and health of people which could occur in case of incorrect product removal. For detailed information on removal and processing of the product, please contact the relevant municipal body in charge of waste management, your waste disposal service, or the store where you bought the product.

A few tips on how to save power with your refrigerator-freezer combo

- Observe the installation instructions.
- Do not open the appliance door more frequently than necessary.
- Occasionally check whether air can circulate freely behind the appliance.
- Condenser unit mounted on the appliance back wall must be kept clean at all times (see section “Cleaning the appliance”).
- If the seal is damaged or loose, replace it as soon as possible.
- Store your food in closed containers or other appropriate packaging.
- Before placing the food in the refrigerator, let it cool down to room temperature.
- Defrost your frozen food in the refrigerator compartment.
- Remove the freezer drawers and door as described in the instructions, in order to make use of the entire capacity.
- Place the cold accumulators (only with some models) directly onto the frozen food, at the front, in the upper section of the freezer compartment.
- Defrost your conventional freezer when a frost layer approximately 3-5 millimetres thick has accumulated on the surfaces in the freezer compartment.
- Make sure the shelves are evenly distributed and that the food is arranged in a way that allows free circulation of air (heed the recommended food arrangement as described in the instructions).
- In appliances fitted with a fan, do not block the fan slots.

Appliance description

TRADITIONAL FREEZER

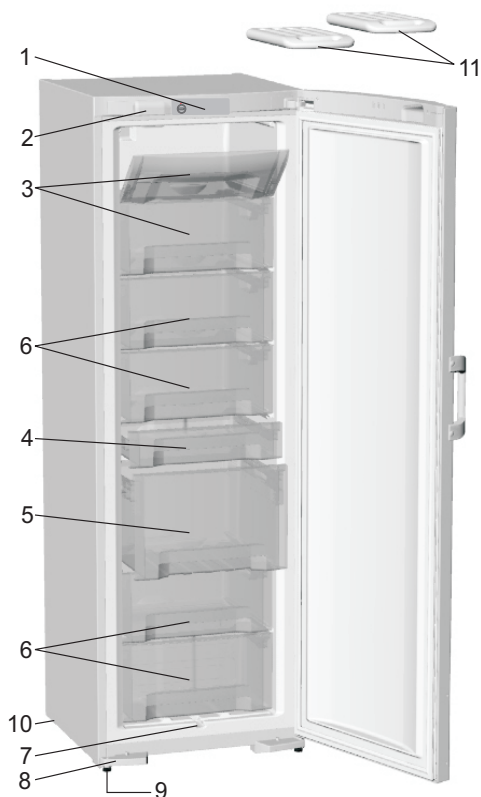

- 1 Control panel
- 2 Interior light*
- 3 Freezing compartment
- 4 Fast freeze for small quantities of food*
- 5 Larger drawer SpaceBox*
- 6 Storage compartment

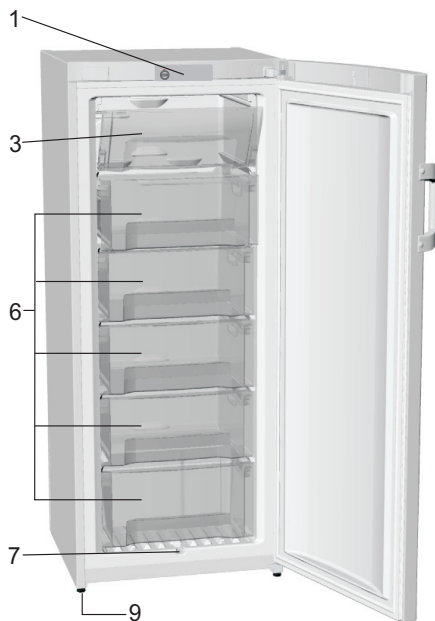

- 7 Defrost drain outlet groove
- 8 Leg support*
- 9 Leg
- 10 Wheels*
- 11 Cold accumulator*

- Interior accessories of the appliance may vary according to the model.
- Drawers are protected against accidental extraction. To extract the drawer from the appliance, open it and lift front part upwards, then pull it out. Certain models are fitted with pull-out slide guides which facilitate opening. Pull-out guide drawers are extracted by lifting the rear end and pulling out inclined under the 45° angle. Reinsert in opposite sequence.

* Certain models only.

NO FROST FREEZER

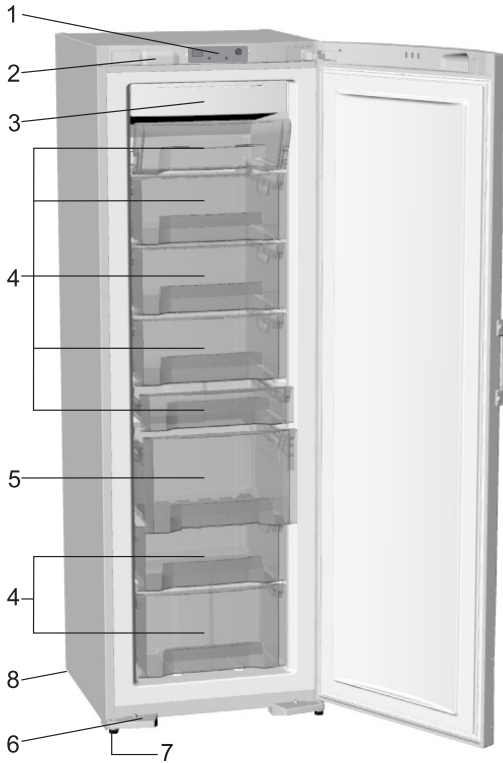

- 1 Control unit
- 2 Interior illumination*
- 3 NO FROST freezing unit (cooler, fan ...)*
- 4 Freezing and storage area
- 5 Large space - SpaceBox drawer*
- 6 Leg support*
- 7 Leg
- 8 Wheel*

- Interior accessories of the appliance may vary according to the model.
- Drawers are protected against accidental extraction. To extract the drawer from the appliance, open it and lift front part upwards, then pull it out. Certain models are fitted with pull-out slide guides which facilitate opening. Pull-out guide drawers are extracted by lifting the rear end and pulling out inclined under the 45° angle. Reinsert in opposite sequence.
- Fan (hid within the freezer unit) provides better distribution of temperature. It is off when the freezer door is open, or during idle compressor periods.

* Certain models only.

Installation and connection

Selecting the room

- The appliance should be installed in a dry and well ventilated room. The appliance will operate correctly if the environment temperature is within the ranges listed in the table below. The appliance class is indicated on the label with the basic information on the appliance.

Class	Temperature
SN (subnormal)	from +10°C to +32°C
N (normal)	from +16°C to +32°C
ST (subtropical)	from +16°C to +38°C
T (tropical)	from +16°C to +43°C

Installing the appliance

Appliance installation should be carried out by at least two persons to avoid any physical injury or damage to the appliance.

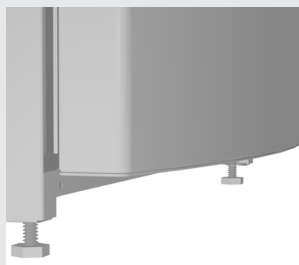

- The appliance should stand firmly in an upright position on a sufficiently solid base. At the front, the appliance is fitted with two adjustable legs that can be used to level the appliance (only with some models). Rear side of the appliance is fitted with wheels (certain models only) facilitating the positioning of the appliance at the preselected place.
- If there is a kitchen furniture element above the appliance, there should be a clearance of at least 5 centimeters between this element and the refrigerator, to ensure sufficient cooling of the condenser unit.
- Do not expose the appliance to direct sunlight and do not place it near sources of heat. If this cannot be avoided, install an insulation panel.
- Two spacers attached to the appliance must be fitted onto the upper edge of the condenser, thus preventing the appliance from being installed too close to the wall (only some models have it). Spacers are manufactured for all-purpose function depending on the distance of the condenser from the appliance. Therefore turn spacers correspondingly and fix them to the appliance.

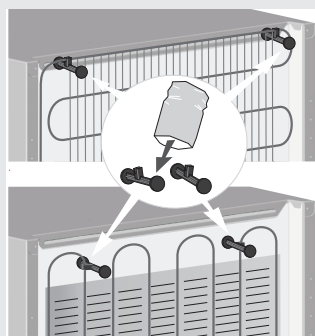

- Bottom front corners of the appliance is fitted with handles to facilitate moving. The appliance may stand freely or it can be placed next to a kitchen furniture element or a wall. Mind the space required to open the door and pull out the drawers and shelves (see installation diagram).

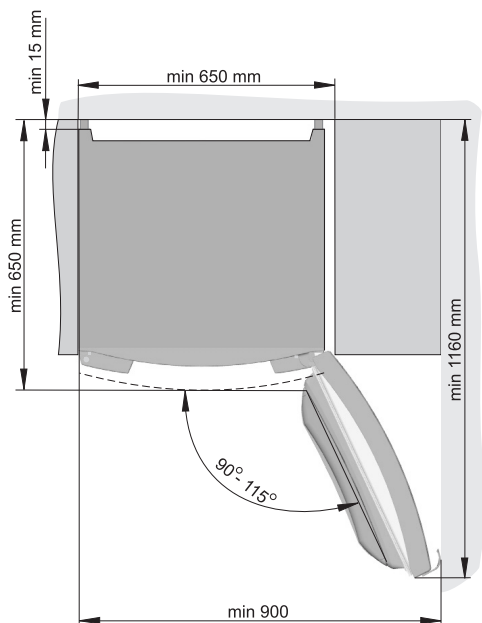

Note: When placing the appliances side by side, the anti-dew (anti-condensation) set has to be purchased and installed.

Code for ordering the set: 151046

Connecting the appliance

- Use the power cord to connect the appliance to the power mains. The wall outlet should be fitted with a ground contact (safety socket). Nominal voltage and frequency are indicated on the label with basic information on the appliance.
- The appliance should be connected to the power mains and grounded in compliance with the relevant effective standards and regulations. The appliance will withstand short-term deviations from the nominal voltages, but not more than from -6% to +6%.

Changing the door opening direction

Tools required: ring spanner (box-end wrench) No. 8, screwdriver, torx25, flathead screwdriver

1. Use the flat-bladed screwdriver to remove the covers A and B1.
2. Remove, starting from the top and working your way down: hinge (C), door (D), and hinge (E1).
Make sure the door is not damaged.
3. Move the cover plugs (H) to the opposite side.

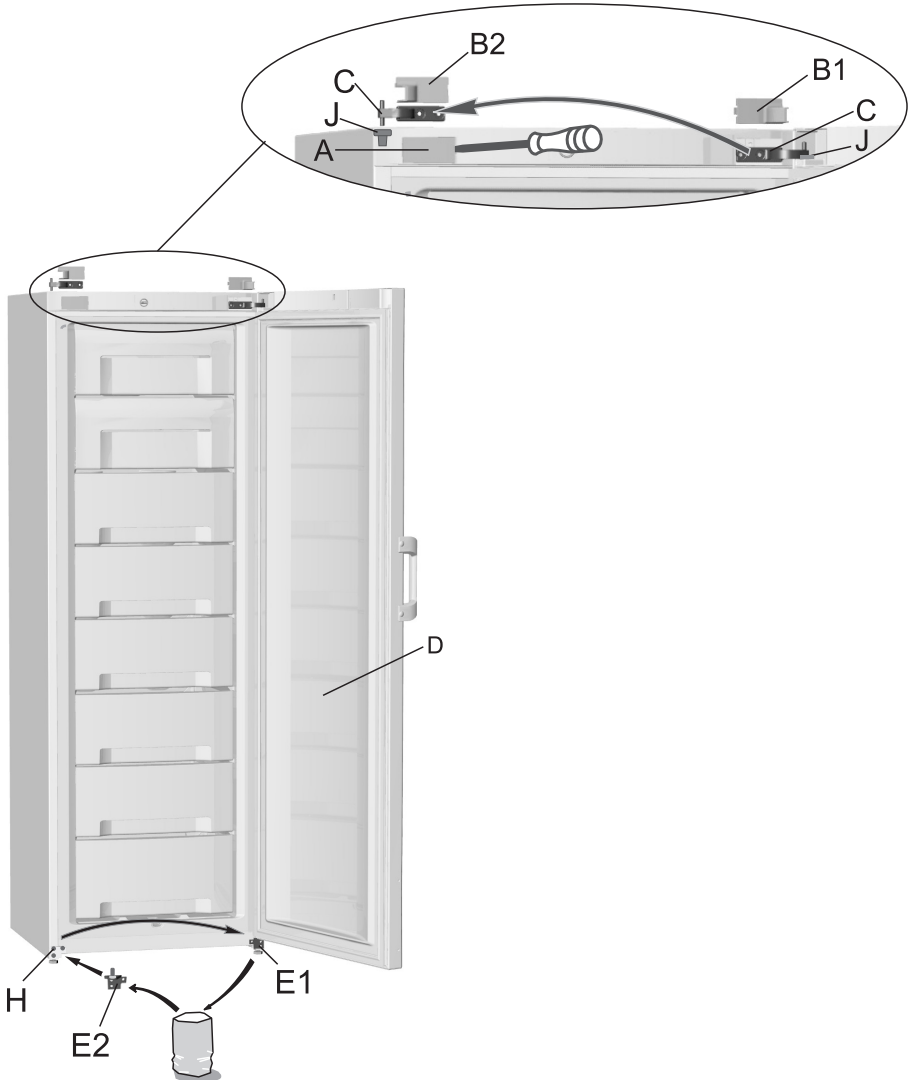

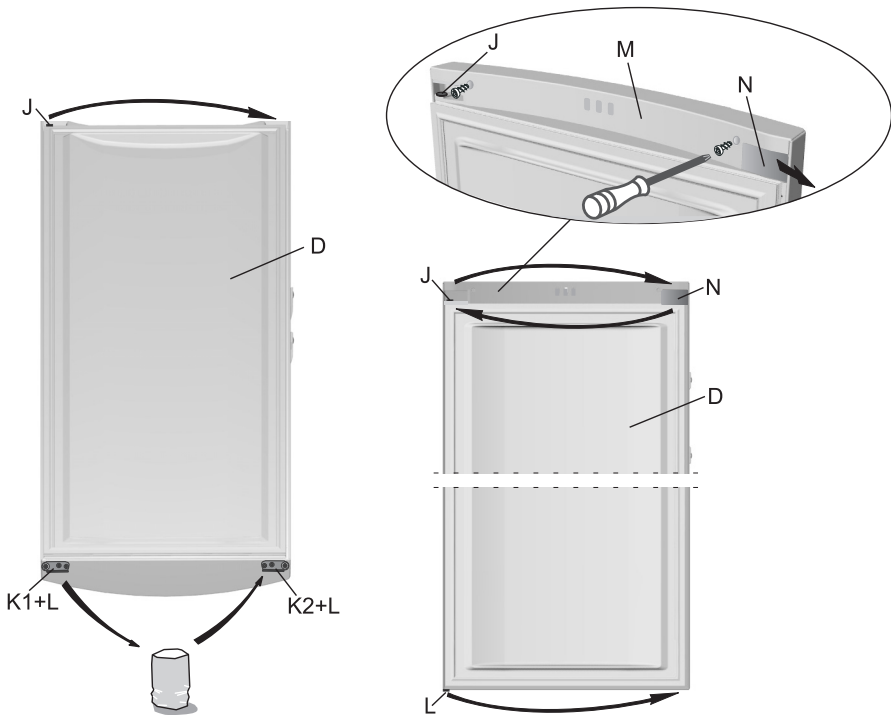

4. **VERSION I: Door (D):** move the hinge (J) to the opposite side. Remove the door retainer (K1) with the support (L) and attach a symmetric retainer (K2) supplied in the bag along with the support (L), on the opposite side.
VERSION II: Door (D): undo the screw of the door cover (M) and remove it, including the cover (N). Move the hinge (J) to the opposite side of the door. Rotate the cover (N) by 180° and move it to the opposite side of the cover (M); then, reattach the cover. Remove the door retainer (K1) with the support (L) and attach a symmetric retainer (K2) supplied in the bag along with the support (L), on the opposite side.
5. Starting at the bottom and working your way up: attach the lower hinge (E2, supplied in the bag), mount the door (D), and attach the hinge (C). Do not forget to replace the washers as they were before disassembling.
6. Install the covers A and B2 (cover B2 is supplier in the bag).
7. **Changing the handle:** remove the covers, undo the screws, and reattach the handle on the opposite side. Replace the covers on the opposite side. Insert the plugs supplied in the bag into the holes where the handle used to be attached.

Save the parts B1, E1, and K1 in case you need to change the direction of door opening again at a later time.

* Retainers K1 and K2 are only installed on some models.

Version III

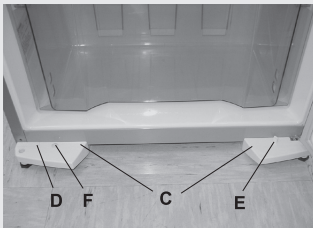
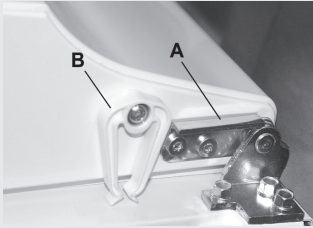
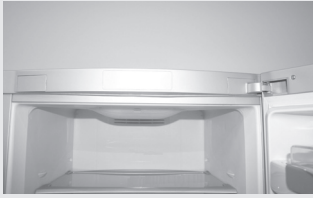

Required tools: socket spanner nr. 8, screwdriver, torx 25
Caution! After unscrewing of before fixing hinges, hold the door to prevent it from falling and damaging.

1. Remove upper hinge cover (keep it for eventual later use), together with cover on the opposite side of the upper hinge cover (on the opposite side you will insert the attached cover during the assembly), and remove the cover on the opposite side of the upper part of the door.
2. Unscrew upper hinge screws and remove the door from the bottom hinge.
3. On the bottom side of the door unscrew the swing stopper screws and remove the stopper (A). Keep this for later use. Fix the attached stopper with its bearing on the opposite side of the door.
4. Unscrew the forced door closure system (B) and fix it to the opposite side of the door (certain models only).
5. Tilt the appliance backward (max. 35°) to lean to the rear side of the cabinet. Unscrew the leg support screws (C) - left and right, and remove the leg support cover (D). Unscrew and remove, then reciprocally replace the position of end switch (E) and decorative peg (F) (for models with forced door closing system). Place this on the opposite side. Unscrew three screws fixing the bottom hinge (keep this for possible later use), and fix the attached bottom hinge on the opposite side.
6. Proceed with the assembly procedure in opposite sequence.

Note:

In appliances with the handle along the entire height of the door, the reverse door swing is not possible.

Operating the appliance

CONTROL UNIT I

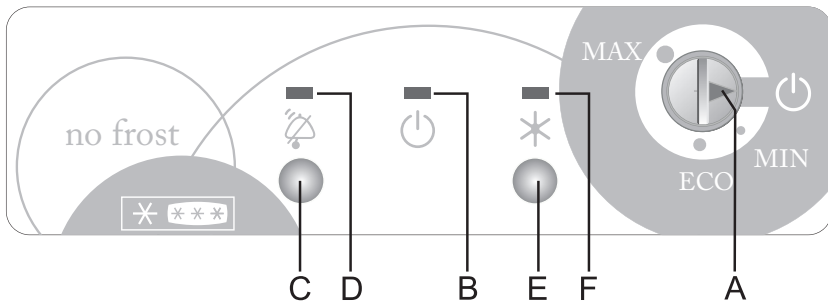
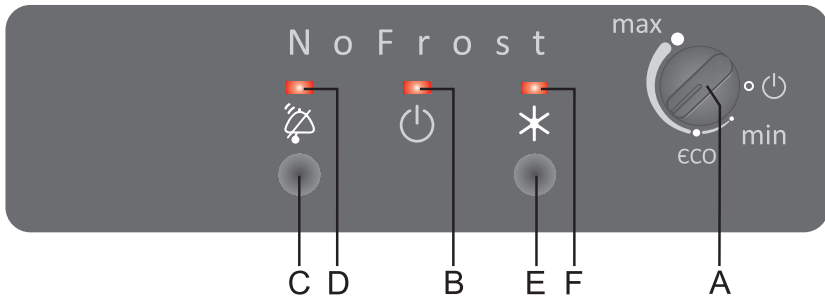

CONTROL UNIT II

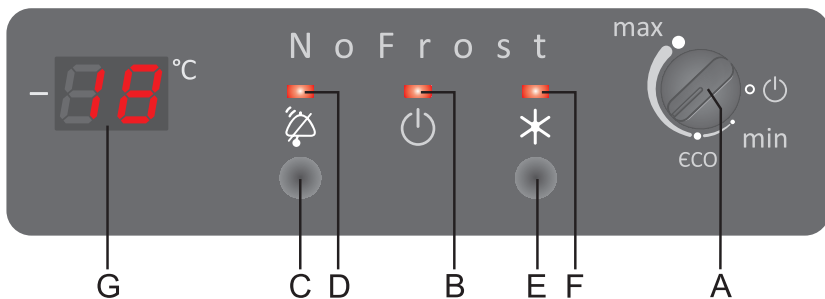

A Temperature setting dial and on/off switch

B Signal light: on when appliance is in operation

C Freezer sound alarm acknowledgment key

D Signal light: flashing during freezer alarm

E Freezer power boost key

F Signal light: on when the freezer power boost is activated

G Digital temperature display indicates actual temperature in the appliance from -16°C to -24°C *

* Only with some models.

No Frost sign – only with some models

Switching the appliance on/off

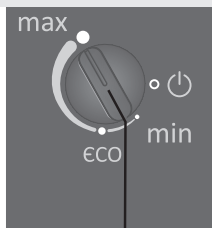

A

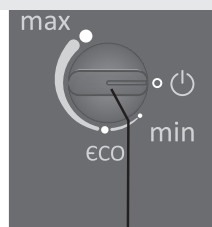

A

Setting the temperature in the appliance

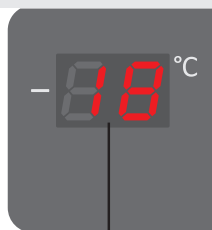

G

Switch on the appliance by rotating the **A** dial towards the **max** sign.
Signal light **B** goes on. To switch off the appliance, align the recessed part of the dial with the  sign (there is still current and voltage in the appliance).

- Set the desired temperature with the **A** dial. The temperature can be set in the zone from **min** to **max**.
- Recommended setting of the thermostat dial is at the **eco** position (or -18°C for appliances with digital display).
- In appliances with digital display, the display will flash while temperature settings are being changed, displaying the set temperature. When the flashing stops, the setting procedure is complete and the setting is automatically stored. After switching on the appliance for the first time, temperature -16°C is indicated on the display **G**, flashing. This display is indicated until the temperature drops below this level. Then, the flashing stops and the digital display indicates actual current temperature.

Freezer power boost

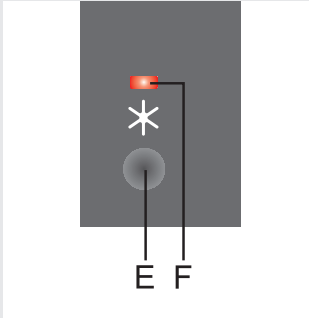

- Use this setting after switching on the appliance for the first time, before cleaning, and when adding larger quantities of food (see “Freezing process”).
- Press the **E** key – signal light **F** goes on. The function is automatically deactivated after two days.

High freezer temperature alarm

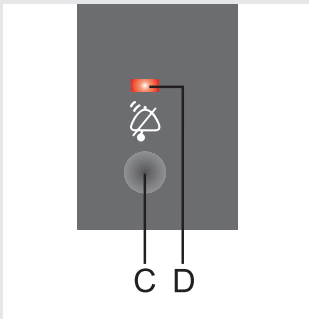

If the temperature is too high, the signal light **D** will start flashing and an intermittent acoustic alarm will be activated. The alarm is switched off automatically when the freezer has cooled down to a temperature that no longer presents hazard of food spoiling.

- After the appliance is switched on for the first time, there is a 24-hour delay in freezer alarm operation, because it is expected that the temperature in the freezer compartment has not dropped to an adequately low level. This prevents unnecessary alarms.
- Acknowledge and turn off the sound alarm by pressing the **C** key.
- The sound alarm will be activated every 24 hours if the temperature in the freezer is not low enough to prevent the food from spoiling.

CONTROL UNIT III

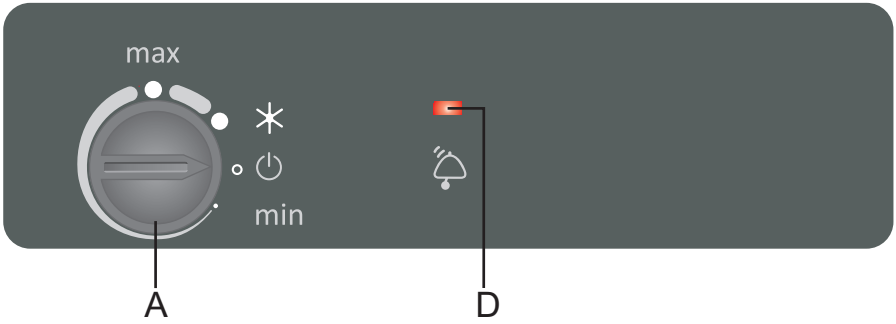

CONTROL UNIT IV

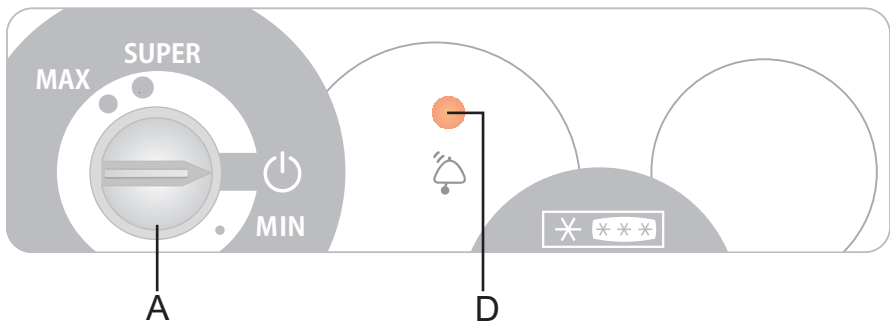
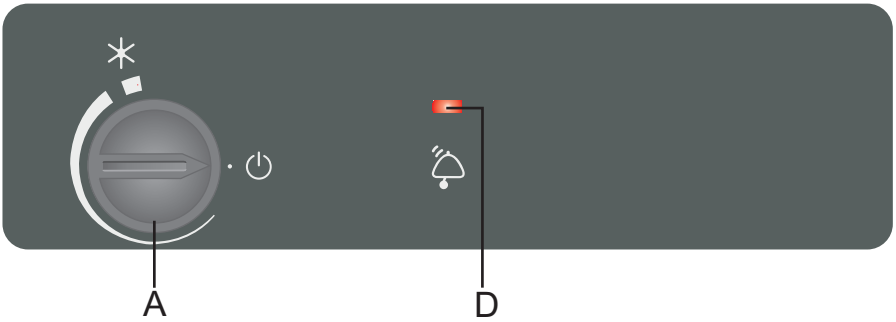

A Temperature setting knob, on/off, and freezer power boost

D Signal light on/ flashing: High temperature alarm

Turning the appliance on

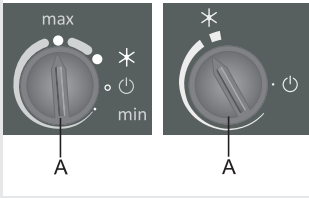

Rotate the thermostat knob **A** clockwise towards the thicker end of the sign.

Control unit III:

When the appliance is switched on for the first time, the **D** signal light will be on. It will go off automatically when the freezer cools down to a temperature that no longer presents danger of food spoilage.

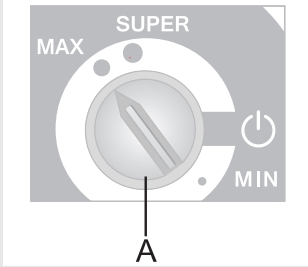

Control unit IV:

When the appliance is switched on for the first time, there is a 24-hour delay in temperature alarm operation since the appliance will not have reached the adequate temperature. Thus, unnecessary activation of alarm is prevented.

Turning the appliance off

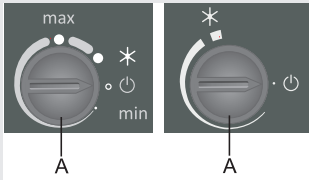

Rotate the **A** knob back to the position where the arrow is pointing to the  symbol (the appliance is still powered).

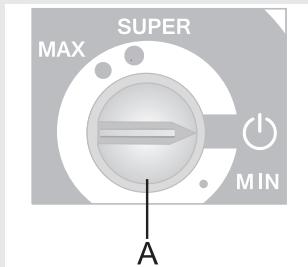

Setting the appliance temperature

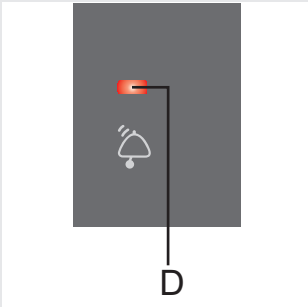
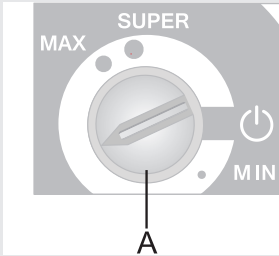
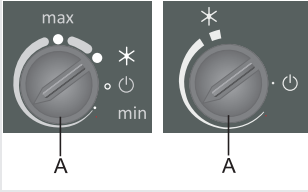

- Recommended setting for the thermostat knob **A** is half way between the thinner and the thicker end of the sign.
- A change in the environment temperature will affect the temperature in the appliance. The thermostat knob setting should be adjusted accordingly.

Positions towards the thicker part of the sign mean a lower temperature in the appliance (cooler). Settings towards the thinner part of the marking mean a higher temperature (warmer).

- Signal light **D** will be on/will flash when the temperature in the freezer rises to a level that is too high, and goes off when the temperature drops back to a level that no longer represents food spoilage hazard (see section »Troubleshooting«).

Freezing fresh food and storing frozen food

Freezing procedure

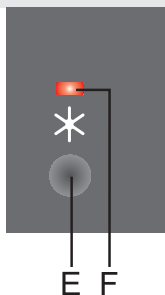

⚠ Maximum quantity of fresh food that can be introduced into the appliance at a time is indicated on the label with basic information on the appliance. If this quantity is exceeded, freezing quality will deteriorate, as will the quality of the already frozen food.

- Activate the freezer power boost 24 hours before freezing fresh food:
 - **control units I and II:** press the **E** key (signal light **F** will light up),
 - **control unit III and IV:** rotate the dial **A** to position ***** (freezer power boost).

After 24 hours, place the fresh food into the freezing area / compartments. Fresh food should not be in contact with the frozen food already in the freezer!

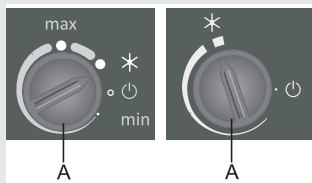

- When freezing a minor quantity of food (1-2 kg), activating the Super Freeze function is not necessary.
- After 24 hours, the food can be moved to other parts of the freezers and the freezing process can be repeated as required.
- After the freezing process, rotate the **A** dial back to the desired setting (**control unit III and IV**).
- If the freezer boost is not deactivated manually, it will be automatically switched off after approximately 2 days. Then the temperature of the freezer compartment returns to the most recently set value (knob position remains at *****).
- Freezer models NO FROST allow freezing in all drawers, but not more than 7 kg in any particular drawer, and 4 kg in the bottom drawer.
- In order to make use of the entire freezer capacity, remove the drawers and place the food packages directly on the shelf.

Important warnings on freezing fresh food

- ⚠ The freezer should only be used for freezing food that is appropriate for freezing. The food should always be fresh and of adequate quality.**
- ⚠ Choose an appropriate packaging for the food and package it correctly.**
- ⚠ The packaging should be airtight and watertight to prevent loss of humidity or vitamins from the food.**
- ⚠ Indicate the type of food, quantity, and freezing date on each food package.**



It is important that the food is frozen as quickly as possible; therefore, smaller packages should be preferred. Before freezing, the food should be cooled.

Avoid contamination of food

To avoid contamination of food, please respect the following instructions:

- Opening the door for long periods can cause a significant increase of the temperature in the compartments of the appliance.
- Regularly clean surfaces that can come in contact with food and accessible drainage systems.
- If the refrigerating appliance is left empty for long periods, switch off, defrost, clean, dry, and leave the door open to prevent mould developing within the appliance.

Storing pre-frozen food

- When storing or using frozen food, observe the manufacturer's instructions. Temperature and best before date are indicated on the packaging.
- Only choose food with undamaged packaging, stored in freezers at temperatures of -18°C or lower.
- Do not buy a food package covered with frost, as this is a sign that the food has been slightly thawed several times. Such food is of lesser quality.
- When transporting frozen food, prevent it from defrosting / thawing. Higher temperature will result in shorter storage time and deteriorated food quality.

Storage times for frozen food

Recommended time for storage in the freezer

Food	Time
fruit, beef	from 10 to 12 months
vegetables, veal, poultry	from 8 to 10 months
venison	from 6 to 8 months
pork	from 4 to 6 months
chopped, dice, or ground meat	4 months
bread, pastry, ready-to-eat meals, lean fish	3 months
tripes / innards	2 months
smoked sausage, fatty fish	1 month

Defrosting frozen food

Microorganisms are not destroyed by freezing. After defrosting, their activity is resumed intensively and the food may perish quickly. Therefore, use the thawed food as quickly as possible. Partial thawing decreases the nutritive value of the food, particularly fruit, vegetables, and ready-to-eat food.

Icemaker function



Remove the cover of the ice mold (only supplied with some models) and fill it with cold water or other fluid suitable for freezing, up to the marking. Close it and place in on the freezer shelf with mold-side down.

The ice mold enables making eight cubes of ice. We recommend making a stock of ice cubes. To take the cubes from the mold, pour some cold water over it, shake it, open the cover, and shake the cubes from the mold.

Cold accumulator (only with some models)

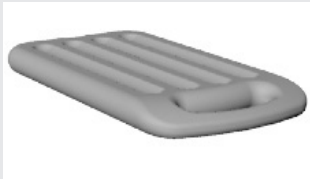

In case of a power failure, cold accumulators will slow down the temperature increase. They are the most efficient when placed directly over the frozen food, in the upper freezing compartment. If the cold accumulators are not used, power consumption may be higher and the appliance may need defrosting more frequently.

Defrosting the appliance

Defrosting traditional freezer

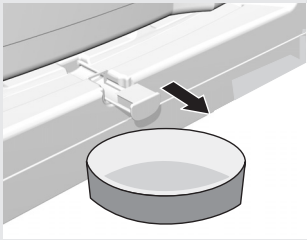

- The freezer should be defrosted 2 – 3 times a year, or more often if appliance door is opened more frequently. Moving the cold accumulators (only with some models) directly onto the frozen food in the upper freezer compartment may reduce the number of times the freezer needs to be defrosted.
- 24 hours before defrosting, activate the freezer power boost to additionally cool the food (see chapter “Freezing process”).

After 24 hours, remove the frozen food from the freezer and protect them from thawing.

- Disconnect the appliance – rotate the thermostat knob **A** to the  position and unplug the power cord from the wall outlet.
- Pull out the drain trough on the bottom of the freezer and place a container under it to collect the water from thawed ice and frost.
- Do not use electrical appliances to defrost the appliance (hairdryer etc.);
- When defrosting the refrigerator, do not use any defrosting sprays as these may damage the plastic surfaces or harm your health.
- Clean the appliance interior and wipe it dry (see cleaning the appliance).
- Before putting the food back into the freezer, connect the appliance to the power mains and rotate the **A** knob back to the desired setting.

Defrosting the NO FROST freezer

- Defrosting of NO FROST freezer is automatic. Periodic appearance of frost layer eventually disappears automatically.

Cleaning the appliance

Before cleaning, disconnect the appliance from the power mains – rotate the thermostat knob **A** to the  position and unplug the power cord from the wall outlet.

- Use a **soft cloth** to clean all surfaces. Cleaners containing **abrasive particles, acids, or solvents, are not appropriate** as they will damage the surface.

Clean the **appliance exterior** with water or a mild solution of suds.

Lacquer-coated and aluminum surfaces can be cleaned with lukewarm water to which some mild detergent was added.

Cleaning agents with minor alcohol content are also acceptable (e.g. window cleaners).

Cleaners with alcohol content are not allowed for cleaning plastic parts.

Clean the appliance **interior** with lukewarm water to which you may add some **vinegar**.

- Frost and ice accumulated in a layer of 3-5 mm will cause an increase in power consumption; therefore it should be removed regularly (this does not apply to the NO FROST freezer). Do not use any sharp objects, solvents, or sprays.

- **Condenser unit** on the back of the refrigerator should always be kept clean, free of dust or deposit from kitchen smoke. Use a soft non-metal brush or a vacuum cleaner to clean the dust periodically.
- After cleaning, switch on the appliance and put the food back in.

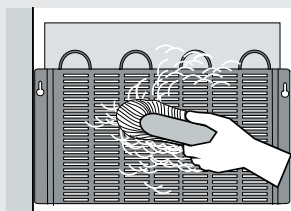

Troubleshooting

Problem:	Cause or remedy:
After connecting to the power mains, the appliance does not operate:	<ul style="list-style-type: none"> • Make sure the wall outlet is powered and that the appliance is plugged in.
Cooling system has been working continuously for a long period of time:	<ul style="list-style-type: none"> • Too high environment temperature. • Door is open too often or it is left open too long. • Door is not closed appropriately (there may be dirt between the door and the refrigerator, the door may be tilted, the seal should be checked, etc.). • Too much fresh food was inserted. • Insufficient compressor and condenser cooling. Check the air circulation behind the appliance and clean the condenser.
Ice accumulation in the freezer interior is a result of:	<ul style="list-style-type: none"> • Poor door sealing. If the seal is dirty or damaged, clean or replace it. • Door is opened too often or left open too long. • Placing warm food into the freezer.
D light is on/is flashing:	<ul style="list-style-type: none"> • Frequent opening of the door, door open too long. • Door not closed properly (particle between door gasket, sagged door, damaged gasket, etc...). • Excessively long power failure. • Excessive quantity of fresh food inserted at once.
Door won't open easily:	<ul style="list-style-type: none"> • If you wish to open freezer door immediately or shortly after closing it, you may feel rather strong resistance. When the freezer door is opened, some cool air escapes from the freezer compartment and it is replaced by warm air from the environment. When this air is cooled, a sub-pressure builds up, causing resistance to door opening. After a few minutes, the condition is normalized and the door can be easily opened again.
Bulb replacement (certain models only):	<ul style="list-style-type: none"> • Before replacing the light bulb, disconnect the appliance from the power supply. Remove the plastic cover, replace the bulb with a new one (E 14, max. same voltage as the factory one) and fit back the cover. • Please dispose of this correctly. • Light bulb is consumption material and is not covered by the warranty. • Bulb lamps used in this appliance are special purpose lamps selected for household appliances use only. They are not suitable for household room illumination.
	
Signal light B is flashing:	<ul style="list-style-type: none"> • If the signal light B is flashing, call a service technician.
Occurrence of murmur after closing the door:	<ul style="list-style-type: none"> • After closing the door, some murmur can occur. This phenomenon is normal and is due to pressure equalisation.
Error code displayed (certain models only):	<ul style="list-style-type: none"> • If the character E appears on the digital display (certain models only), call service assistance.

If none of the above reasons seems to match your problem, please contact the nearest service center and state the type, model and serial number as indicated on the label with basic information attached in the appliance interior.

Cooling in the refrigerators-freezers is enabled by a cooling system with a compressor (with some appliances also a fan), which emits a certain level of noise during operation. The level of noise depends on installation, proper use, and appliance age.

- **After appliance startup**, the compressor may be somewhat louder (fluid noise, noise caused by refrigerant flowing through the system). This is not a sign of malfunction and it will not affect the appliance useful life. Eventually, the level of this noise will be reduced.
- Occasionally, **sudden or louder noise** may appear during appliance operation, which will appear uncommon; these are mostly the result of improper installation:
 - The appliance must be placed horizontally and firmly on a solid base.
 - The appliance should not be in contact with the wall or adjacent elements.
 - Make sure the appliance interior equipment is appropriately fitted and that the noise is not caused by vibrating cans, bottles, or other containers in contact with each other.

WE RESERVE THE RIGHT TO CHANGES THAT TO NOT AFFECT THE APPLIANCE FUNCTIONALITY.

Instructions for use of the appliance can also be found on our website at www.gorenje.com / < <http://www.gorenje.com> />

ZOS2467
ZOS2461
ZOS2467C
ZOS3167
ZOS3161
ZOF2467C
ZOF2461C
FREEZER BASIC



302967