

MT **IE** **GB**

**Instructions for use, installation
and connection**

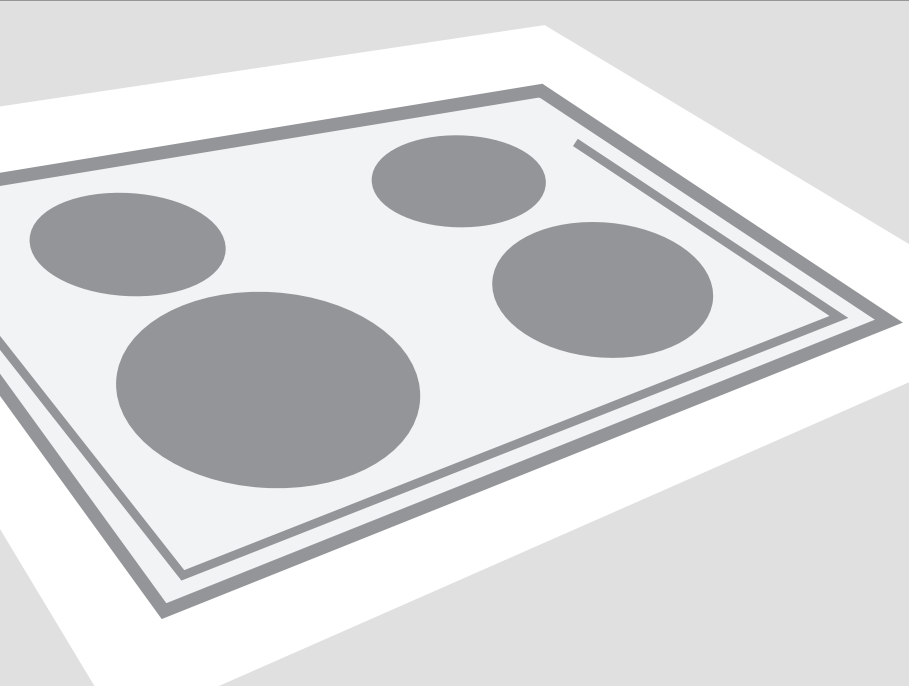

Glass-ceramic induction built-in cooking hob

Glass-ceramic built-in cooking hob

Dear customer!



Glass-ceramic hob is intended for use in households.

Our products are packed in environment-friendly materials which can be recycled, disposed of, or destroyed without imposing any burden on the environment.

Instructions for use

Instructions for use are intended for the user. They describe the appliance and its operation. The instructions apply to various types of appliances and may therefore include description of functions that may not be available on your appliance.

Instructions for connection

The appliance must be connected in compliance with the instructions attached to it, as well as in compliance with relevant regulations and standards. The connection may only be performed by a qualified person.

Rating plate

The rating plate indicating the basic information on the appliance is attached to the lower side of the hob.

Fire risk protection

When the cooking hob is built-in, a kitchen furniture element that is higher than the hob can stand next to in on one side, provided the kitchen element on the other side of the hob is not higher than the hob level.

Important - Read before using the appliance	3
Appliance description	5
Use	9
Operation.....	12
Cooking	21
Maintenance.....	22
Troubleshooting	23
Installation instructions	24

Important - Read before using the appliance

Safety precautions

- This appliance can be used by children aged from 8 years and above and persons with reduced physical, sensory or mental capabilities or lack of experience and knowledge if they have been given supervision or instruction concerning use of the appliance in a safe way and understand the hazards involved. Children shall not play with the appliance. Cleaning and user maintenance shall not be made by children without supervision.
- **WARNING:** The appliance and its accessible parts become hot during use. Care should be taken to avoid touching heating elements. Children less than 8 years of age shall be kept away unless continuously supervised.
- **WARNING:** Danger of fire: do not store items on the cooking surfaces.
- **WARNING:** Unattended cooking on a hob with fat or oil can be dangerous and may result in fire. Never try to extinguish a fire with water, but switch off the appliance and then cover flame with a lid or a damp cloth.
- After use, switch off the hob element by its control and not rely on the pan detector.
- **WARNING:** If the surface is cracked, switch off the appliance to avoid the possibility of electric shock.
- Metallic objects such as knives, forks, spoons and lids should not be placed on the hob surface since they can get hot.
- Do not use steam cleaners or high-pressure cleaners to clean the cooking hob, as this may result in an electric shock.
- The appliance is not intended to be controlled by external timers or special control systems.

Warnings

- The appliance may only be connected to the power mains by an authorized service technician or expert.
- Tampering with the appliance or non-professional repair thereof may result in risk of severe injury or damage to the product. Any repairs may only be carried out by an authorized service technician or expert.

- The appliance is intended solely for cooking. Do not use it for any other purpose, e.g. for room heating. Do not place empty cookware on the cooking zones.
- If another electrical appliance is connected to a AC power socket near the appliance, make sure the power cord does not come into contact with hot cooking zones.
- Do not store temperature-sensitive items underneath the appliance, such as cleaners or detergents, spray cans etc.
- Using the glass ceramic hob as a storage area may result in scratches or other damage to it. Never heat food in aluminium foil or in plastic containers on the cooking hob. Such foil or containers may melt which can result in a fire or damage to the cooking hob.
- Do not place objects like knives, forks, spoons, or lids on the induction cooking zone as they can become very hot.



The symbol on the product or on its packaging indicates that this product may not be treated as household waste. Instead it shall be handed over to the applicable collection point for the recycling of electrical and electronic equipment. By ensuring this product is disposed of correctly, you will help prevent potential negative consequences for the environment and human health, which could otherwise be caused by inappropriate waste handling of this product. For more detailed information about recycling of this product, please contact your local city office, your household waste disposal service or the shop where you purchased the product.

Appliance description

Control panel

SIVK6ATF

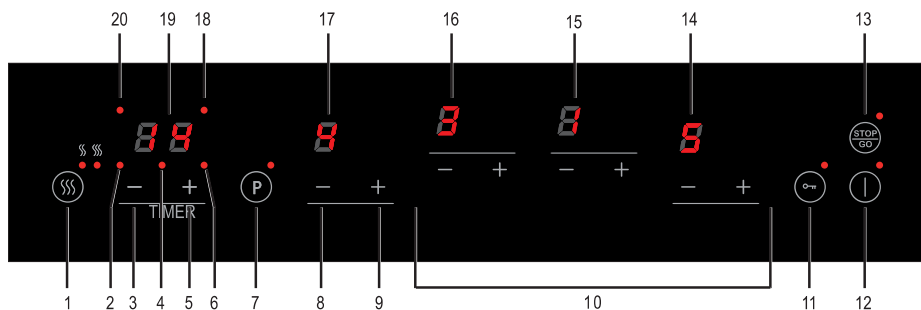

- | | |
|---|---|
| <ol style="list-style-type: none"> 1. Keep food warm/melt with indicator 2. Cooking timer indicator left front zone 3. Reduce time button 4. Minute minder indicator 5. Increase time button 6. Cooking timer indicator right front zone 7. Boost with indicator 8. Decrease power left front zone 9. Increase power left front zone 10. Controls other cooking zones 11. (Child)lock with indicator | <ol style="list-style-type: none"> 12. On/Off button with indicator 13. Stop/Go function with indicator 14. Setting indicator right front zone 15. Setting indicator right rear zone 16. Setting indicator left rear zone 17. Setting indicator left front zone 18. Timer indicator right rear zone 19. Timer indicator cooking timer/minute minder 20. Timer indicator left rear zone |
|---|---|

Description

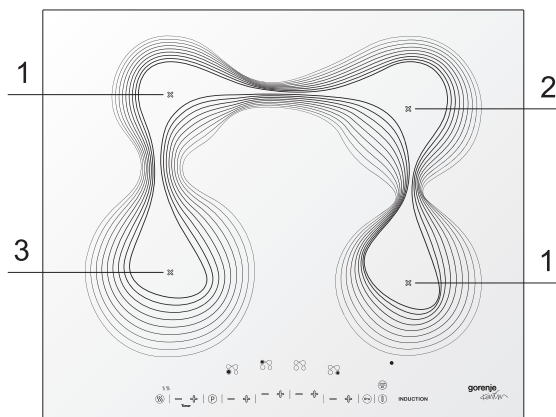

1. Cooking zone $\Phi 145\text{mm}$; 2,2kW
2. Cooking zone $\Phi 180\text{mm}$; 3,0kW
3. Cooking zone $\Phi 210\text{mm}$; 3,7kW

What you should pay attention to

Induction cooking is extremely safe. Various safety devices have been incorporated in the hob such as a residual heat indicator and a cooking time limiter. There are nevertheless a number of precautions you should take.

Connection and repair

- This appliance may only be connected by a qualified installer.
- Never open the casing. The casing may only be opened by the service technician.
- Disconnect the electricity from the appliance before starting any repair work. Preferably unplug the appliance, switch the (automatic) fuse(s) off or, in the event of a permanent connection, set the switch in the power supply lead to zero.

During use

- Do not use the hob in temperatures below 5°C.
- This cooking appliance is designed for household use. It is to be used for food preparation only.
- When you use the hob for the first time you will notice a “new smell”. This is normal. If the kitchen is well ventilated the smell will soon disappear.
- Remember that if the hob is used on a high setting the heating time will be incredibly short. Do not leave the hob unattended if you are using a zone on a high setting.
- Ensure there is adequate ventilation while the hob is in use. Keep all natural ventilation openings open
- Do not allow pans to boil dry. The hob itself is protected against overheating but the pan will get very hot indeed and could be damaged. The guarantee does not cover any damage caused by a pan boiling dry.
- Do not use the cooking area as storage space
- Ensure that there is several centimetres clearance between the hob and the contents of the drawer.
- Do not keep anything combustible in the drawer under the hob.
- Make sure that flexes of electrical appliances, such as a mixer, cannot touch the hot cooking zone.
- The zones heat up during use and stay hot for a while afterwards. Keep young children away from the hob during and immediately after cooking.
- Grease and oil are inflammable when overheated. Do not stand too close to the pan. Should oil catch fire, never try to extinguish the fire with water. Put a lid on the pan immediately and switch the cooking zone off.
- Never flambé food under the cooker hood. The high flames could cause a fire, even if the cooker hood is switched off.

- The ceramic top is extremely strong, but not unbreakable. A spice jar or pointed utensil falling on it, for example, could cause it to break.
- Stop using the hob if a break or crack appears. Switch the appliance off immediately, unplug it to avoid electric shocks, and call the service department.
- Never put any metal objects such as baking trays, biscuit tins, saucepan lids or cutlery on the cooking zone. These can heat up extremely quickly and cause burns.
- Keep magnetizable objects (credit cards, bank cards, floppy disks, etc.) away from the appliance. We advise anyone with a pacemaker to consult their cardiologist before using an induction hob.
- Never use a pressure cleaner or steam cleaner to clean the hob.
- This appliance is not intended for use by persons (including children) with reduced physical, sensory or mental capabilities, or lack of experience and knowledge, unless they have been given supervision or instruction concerning use of the appliance by a person responsible for their safety.
- As soon as you remove the pan from the hob, the cooking zone automatically stops. Accustom yourself to stop the cooking zone or hob manually to avoid unintended switching on of the induction hob.
- A small object like a pan that is too small (diameter of bottom smaller than 12 cm), a fork or a knife will not be recognised by the appliance. The display continues to flash and the hob will not switch on.
- The appliance is not intended to be operated by means of an external timer or separate remote-control system.

Temperature safety

- A sensor continuously measures the temperature of certain parts of the hob. Every cooking zone is equipped with a sensor that measures the temperature of the bottom of the pan to avoid any risk of overheating when a pan boils dry. In case of temperatures rising too high, the power is reduced automatically.

Cooking-time limiter

The cooking-time limiter is a safety function of your cooking appliance. It will operate if you forget to switch off your hob.

Depending on the setting you have chosen, the cooking time will be limited as follows:

Setting	The cooking zone switches automatically off after:
0	12 hours
1	8,5 hours
2	6,5 hours
3	5 hours
4	4 hours
5	3,5 hours
6	3 hours
7	2,5 hours
8	2 hours
9	1,5 hours
u	2 hours
U	2 hours

The cooking-time limiter switches the cooking zones off if the time in the table has elapsed.

Setting	The cooking zone switches automatically to setting 9 after:
boost (P)	10 minutes

Getting used to it...

Using the touch controls

The touch controls may take some getting used to if you are used to other (rotary) controls. Place the tip of your finger flat on the control to achieve the best results. You do not have to apply any pressure.

The touch sensors only react to the light pressure of a fingertip. Do not operate the controls with any other objects. The hob will not switch on when your pet walks over it.

Induction cooking

- Induction cooking is fast
 - To start you will be surprised by the speed of induction cooking. Especially at higher settings, foods and liquids will boil very rapidly. It is best not to leave pans unattended to avoid them boiling over or boiling dry.
- The power will be adjusted
 - In the case of induction cooking, it is only the part of the zone on which the pan stands that is used. If you use a small pan on a large zone, the power will be adjusted to the diameter of the pan. The power will thus be lower and it will take longer before the food in the pan comes to the boil.

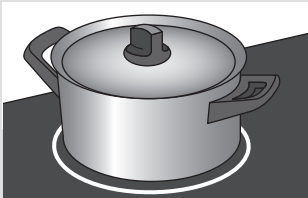

No heat loss and cold handles with induction cooking.

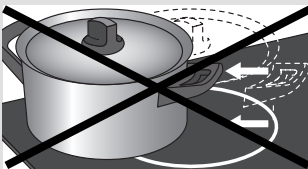
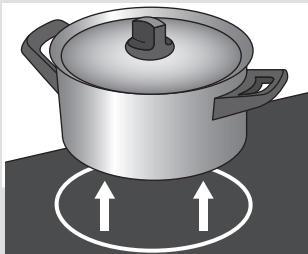

Attention

- ⚠ **Grains of sand may cause scratches which cannot be removed. Only put pans with a clean base on the cooking surface and always pick pans up to move them.**
- ⚠ **Do not use the hob as a worktop. Always keep the lid on the pan when cooking, in order to avoid energy loss.**

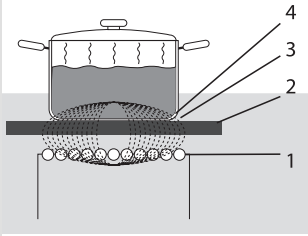

The coil (1) in the hob (2) generates a magnetic field (3). By placing a pan with an iron base (4) on the coil, a current is induced in the base of the pan.

Induction cooking

A magnetic field is generated in the appliance. By placing a pan with an iron base on a cooking zone, a current is induced in the pan base. This induced current generates heat in the base of the pan.

- **Easy**

- The electronic controls are accurate and easy to set. On the lowest setting, you can melt chocolate directly in the pan, for example, or cook ingredients that you would normally heat in a bain-marie.

- **Fast**

- Thanks to the induction hob's high power levels, bringing food to the boil is very quick. Cooking food through takes just as long as for other types of cooking.

- **Clean**

- The hob is easy to clean. Because the cooking zones do not get any hotter than the pans themselves, food spills cannot burn on.

- **Safe**

- The heat is generated in the pan itself. The glass top does not get any warmer than the pan. This means that the cooking zone is considerable cooler compared to that from a Ceramic hob or a gasburner. Once a pan has been taken away, the cooking zone cools down quickly.

Pans

Pans for induction cooking

Induction cooking requires a particular quality of pan.

Attention

- ⚠ **Pans that have already been used for cooking on a gas hob are no longer suitable for use on an induction hob.**
- ⚠ **Only use pans that are suitable for electric and induction cooking with:**
 - a thick base (minimum 2.25 mm)
 - a flat base.
- ⚠ **The best are pans with the 'Class Induction' quality mark.**

Tip



You can check for yourself whether your pans are suitable using a magnet. A pan is suitable if the base of the pan is attracted by the magnet.

Suitable	Unsuitable
Special stainlesssteel pans	Earthenware
Class Induction	Stainless steel
Hard-wearing enamelled pans	Porcelain
Enamelled cast-iron pans	Copper
	Plastic
	Aluminium

Attention



Be careful with enamelled sheet-steel pans:

- the enamel may chip (the enamel comes loose from the steel), if you switch the hob on at a high setting when the pan is (too) dry;
- the base of the pan may warp - due, for example, to overheating or to the use of too high a power level.



Attention

Never use pans with a misshapen base. A hollow or rounded base can interfere with the operation of the overheating protection, so that the appliance becomes too hot. This may lead to the glass top cracking and the pan base melting. Damage arising from the use of unsuitable pans or from boiling dry is excluded from the guarantee.



Minimum pan diameter

- The diameter of a pan must be at least 12 cm. You will achieve the best results by using a pan with the same diameter as the zone. If a pan is too small the zone will not work.



Pressure cookers

- Induction cooking is very suitable for cooking in pressure cookers. The cooking zone reacts very quickly, and so the pressure cooker is quickly up to pressure. As soon as you switch a cooking zone off, the cooking process stops immediately.

Operation

Settings

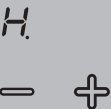
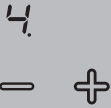

Switching on the hob and setting the power

The power has 9 settings. There is also a 'boost' setting, which is indicated by a 'P.' in the display.

1. Put a pan on a cooking zone.
2. Touch the On/Off button. ①
You will hear a short bleep and the display for each cooking zone will show '0.'. The red light to the right above the On/Off button ① is constantly illuminated. If no further action is taken, the cooking zone will automatically switch off after 10 seconds.
3. Use the button $+$ or the $-$ button in the desired cooking zone to choose the correct setting. The hob will automatically start in the chosen setting (if it detects a pan).
 - Touching the $+$ button for the first time displays setting '4.'.
 - Touching the $-$ button for the first time displays setting '9.'.

Tip



You can touch and hold the $-$ or the $+$ button to set the desired power faster.

- Pan detection
 - If the hob does not detect a (ferrous) pan after the cooking power has been set, the pan detection symbol ⏏ and the selected power setting will flash alternately on the display and the hob will remain cold. If a (ferrous) pan is not placed on the cooking zone within 1 minute, the cooking zone will automatically switch off.
- Residual warmth indicator
 - A cooking zone that has been used intensively will retain heat for several minutes after it has been switched off. An 'H.' appears in the display as long as the cooking zone is hot.



Automatic heat-up function

The automatic heat-up function temporarily increases the power (setting '9.') to heat the contents of the pan faster. This function is available in all settings except the 'Boost' setting and setting '9.'.

Switching on the automatic heat-up function

The hob is switched on and a pan has been placed in a cooking zone.

1. Use the \oplus button in the desired cooking zone to select setting 'A.' (comes after '9.').
'A.' and '9.' flash alternately in the display.

Tip

 A quick way of setting 'A.' is by \ominus setting the cooking zone to '9.' and \oplus touching the button once for setting 'A.'.

2. Use the \ominus or the \oplus button to set the desired power.
If you select power setting 4, '4.' and 'A.' will flash alternately in the display. Attention! After 10 seconds, the \ominus button works as an off button).
3. When the pan has reached the desired temperature, the automatic heat-up function automatically switches off and the cooking zone continues at the set power.

The below table shows the duration of the automatic heat-up function for each power setting:

Setting	1	2	3	4	5	6	7	8
Seconds	40	72	120	176	256	432	120	192

Switching off the automatic heat-up function

The hob is switched on. 'A.' and the power setting flash alternately in the display.

1. Touch the \ominus button for the cooking zone.
A different power setting is shown in the display and 'A.' stops flashing. **Or:**
2. Select setting '9.'. **Or:**
3. Touch the \ominus and the \oplus button for the cooking zone at the same time. The display shows setting '0.', 'A.' stops flashing and the cooking zone is switched off.

Boost

The 'Boost' function is used to cook at maximum power for a short period of time (maximum 10 minutes). The power is reduced to setting 9 at the end of the maximum boost time.

Switching on the boost function

The hob is switched on and a pan is on the cooking zone.

1. Touch the **P** button. (You can also use this button if a power has been set).
2. Touch the **—** or the **+** button for the desired cooking zone. The display shows 'P.'. The boost function is immediately active.

If the **—** or the **+** buttons are not touched, the red light to the right above the **P** button will flash for 3 seconds and then stop. You will hear a single bleep.

Switching off the boost function

The boost function is switched on, the display shows 'P.'.

1. Touch the **—** button. The display shows power setting 9, the boost function is switched off. **Or:**
2. Touch the **—** or the **+** button at the same time. The display shows setting '0.', and the cooking zone is switched off.

- Two cooking zones behind each other
 - Two cooking zones that are behind each other influence each other. The power is automatically distributed when these cooking zones are used at the same time. This does not have any consequences up to setting 9. Selecting the Boost setting for one of the cooking zones, however, automatically switches the other cooking zone to a lower setting.
 - If one of the cooking zones is set to boost and you want to set the other zone to setting 9 or Boost, the cooking zone that is set to boost will automatically be switched to a lower setting.
 - Two cooking zones that are beside each other do not influence each other. You can set both cooking zones to Boost.



Melting/keeping food warm



Use the  button to switch on the function to melt or keep food warm. The cooking timer is used to set the maximum melting/warming time.

The melt function (u)	The function to keep food warm (U)
The melt function keeps the temperature of the food at a constant 42 °C.	The function to keep food warm keeps the temperature of the food at a constant 70 °C.





Switching on the melt function

The hob is switched on and a pan is on the cooking zone.

1. Touch the On/Off button. ①
You will hear a single bleep and the display for each cooking zone will show '0.'
2. Touch the  button once. This is the melt function.
A light to the right above the  button illuminates.
3. Touch the — or the + button for the desired cooking zone.
The display shows 'u.'



Switching on the function to keep food warm

4. Repeat step 1 (see above).
5. Touch the  button twice. This is the function to keep food warm.
Two lights to the right above the  button light up.
6. Touch the — or the + button for the desired cooking zone.
The display shows 'U.'

Switching off the melting/keeping food warm function

The function to melt and keep food warm is switched on. The display shows 'u.' or 'U.'

1. Touch the — or the + button.
Touching the — button displays setting '0.'. Touching the + button displays setting '1.'. The function to melt and keep food warm is now switched off. **Or:**
2. Touch the — or the + button at the same time.
The display shows setting '0.'. The cooking zone is switched off.

Switching off the hob

Switching off one cooking zone

1. The cooking zone is switched on. The display shows a power setting between 1 and 9, or 'P'.
Touch and hold the — and the + buttons for one second to switch off the cooking zone.
Or:

2. Select setting '0.' by touching the  button.

You will hear a bleep and the display will show '0.'. If all of the cooking zones are set to '0.', the hob automatically switches to stand-by mode (see also 'Stand-by mode').

Switching off all of the cooking zones at the same time

The hob is in stand-by mode, or one or more of the cooking zones are active.

1. Briefly touch the On/Off button  to switch off all of the cooking zones at the same time.

You will hear a single bleep. No lights are illuminated.

The cooking zone is now switched off.

Note





You can switch off the hob if the (child) lock is set or the pause mode is active.



Stand-by mode

In stand-by mode, the display for each cooking zone shows '0.'. The hob is switched off and can be left unattended. You can switch to stand-by from 'Off' mode, or by switching off the individual cooking zones (by setting them to '0.'). In stand-by mode, the hob automatically switches off if no other buttons are touched within 10 seconds.

Switching the hob from 'Off' to stand-by mode

1. Touch the On/Off button .

You will hear a single beep and the display for each cooking zone will show '0.'. The red light to the right above the On/Off button  is constantly illuminated.

2. You can start cooking in stand-by mode by touching the  or the  button for the desired cooking zone.

(Child)lock

You can secure the hob with the (child)lock. With this setting, the hob cannot be switched on and the cooking zone settings cannot be changed.

The  button gives you access to the following two functions:





(Standard) lock mode	Child lock mode
The (standard) lock mode prevents settings from being accidentally changed.	The child lock mode prevents the hob from being accidentally switched on.
<u>All of the set cooking processes remain active.</u>	All of the cooking zones and the cooking timers/minute minders must be switched off.

Switch the hob to (standard) lock mode

One or more cooking zones are active.

1. Touch and hold the  button.

Attention! All of the set cooking processes remain active.



The red light to the right above the  button and the On/Off button  are constantly illuminated. All of the buttons are inactive, except the  button and the On/Off button .

2. Touch and hold the  button to switch off lock mode and unlock the control panel.

Switching on the child lock

The hob is in stand-by mode. The display for each cooking zone shows '0.'.

1. Touch and hold the  button to switch on the child lock.

The red light to the right above the  button and the On/Off button  are constantly illuminated.

If no buttons are touched within 10 seconds, the cooking zone will automatically switch off. The child lock remains active. You can even switch off the hob.

Touch the button  again within 10 seconds to switch off the child lock and unlock the control panel.

You must wait 10 seconds before switching the hob on again with the On/Off button  in order to switch off the child lock.

Tip

 **Switch the hob to child lock mode before cleaning it to prevent it accidentally switching on.**

Stop / Go



Use the Stop / Go function to 'pause' the whole hob for 10 minutes while cooking. The power for all of the cooking zones is automatically switched off. This is convenient, for example, if a pan boiled over and you want to clean the hob. You can also leave the hob unattended for a short period of time without losing any settings.

Switching the hob to Stop / Go mode

One or more cooking zones are active.

1. Touch the  button once.

You will hear a single bleep.  is shown in the display for each cooking zone and the red light to the right above the button is constantly illuminated.

- Any set cooking timers/minute minders stop.
- All of the buttons are inactive except the  button, the  button and the On/Off button. 

If no buttons are touched within 10 minutes, all of the active cooking zones are automatically switched off.











Switching off Stop / Go mode

Press the  button again within 10 minutes.

The hob continues with the settings that were set before the Stop / Go.

Recognising a mode

Stand-by mode	The display for each cooking zone shows '0.'. The red light to the right above the On/Off button  is constantly illuminated.
(Standard) lock mode	One or more displays show a power setting. The red light to the right above the  button and the red light to the right above the On/Off button  are constantly illuminated.
Child lock mode	The display for each cooking zone shows '0.'. The red light to the right above the  button and the red light to the right above the On/Off button  are constantly illuminated. All of the lights and displays switch off after 10 seconds. The child lock remains active.
Stop / Go mode	The display for each cooking zone  shows  . The red light to the right above the  button is constantly illuminated. The pause function only works if one or more cooking zones are active.
Memory mode	The display for each cooking zone shows '0.'. The red light to the right above the  button is flashing.

Cooking timer/Minute minder

A cooking timer can be set for each cooking zone. All of the cooking timers can be used at the same time. The hob also has an minute minder. Both the cooking timer and the minute minder can be set to a maximum of 99 minutes.

The minute minder works the same way as the cooking timer, but is not linked to a cooking zone. If set, the minute minder will continue to run after the hob has been switched off. The minute minder can only be switched off when the hob is switched on.

The cooking timer	The minute minder
The cooking timer must be linked to a cooking zone. This means that the cooking zone switches off when the set time elapses.	The minute minder is not linked to a cooking zone. The minute minder continues to run after the hob has been switched off.



Switching on the minute minder

The hob is switched on.

1. Touch the **-** button and the **+** button for the cooking timer and the minute minder once at the same time.
'00.' is shown in the display and the red light in the middle under the display or to the right under the display flashes.
2. Use the **-** button or the **+** button to set the desired time. The minute minder starts running when the dot next to the set time disappears. The red light continues to flash.
If you do not set a time with the **-** and the **+** button, the minute minder will automatically switch off after 10 seconds.

Switching off the minute minder

(Step 1 and 2 are not applicable if one or more cooking zones are active).

1. Touch the On/Off button **⓪** to switch the hob on.
2. Touch the **-** button and the **+** button for the cooking timer/minute minder at the same time.
The dot next to the set time illuminates.
3. Touch and hold the **-** button for the cooking timer/minute minder until '01.' shows in the display. Touch the **-** button again.
The cooking timer/minute minder is now in stand-by mode. The cooking timer/minute minder automatically switches off after 10 seconds.

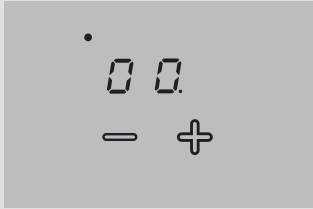

Assigning and switching on the cooking timer

The hob is switched on. The cooking timer can only be linked to active cooking zones.

1. Touch the \cdot and $-$ the $+$ button for the cooking timer/minute minder twice at the same time to set the timer for the first active cooking zone (in this example, the cooking timer for the rear left zone is active).

Every time the $-$ and the $+$ buttons are touched again at the same time, you will move to the cooking timer to the next active zone, which you can set and view.

2. Use the $-$ or the $+$ buttons to set the desired cooking time. The cooking timer starts running when the dot next to the set time disappears. The red light for the cooking timer for the active cooking zone continues to flash. If you do not use the $-$ and the $+$ buttons to set a time, the cooking timer will automatically switch off after 10 seconds.
3. Repeat steps 1 and 2 to set the time for another active cooking zone.

Attention!



If several cooking timers/minute minders are running, the cooking timer/minute minder display will always show the cooking timer/minute minder that has the least time remaining.

Switching off the cooking timer

1. Touch (repeatedly) the $-$ and the $+$ button of the cooking timer/minute minder at the same time to select the time you want to switch off.

The dot next to the set time illuminates.

2. Touch and hold the $-$ button for the cooking timer/minute minder until '01.' shows in the display. Touch the $-$ button again.

The cooking timer is now in stand-by mode. The selected cooking timer automatically switches off after 10 seconds.

Switching off the cooking timer/minute minder alarm

When the set time/cooking time has elapsed, the alarm rings and the red light for the active cooking zone/minute minder flashes '00'.

1. Touch any button to switch off the alarm.



- You can touch and hold the $-$ or the $+$ button to set the desired cooking time faster.
- If you press the $-$ button immediately after switching on the cooking timer/minute minder, you can set the desired cooking time starting at 30 minutes (the display shows '30.').

Healthy cooking

Burning point of different types of oil

To ensure your food is fried as healthily as possible, Gorenje recommends choosing the type of oil according to the frying temperature. Each oil has a different burning point at which toxic gasses are released. The below table shows the burning points for various types of oil.

Oil	Smoke point °C
Extra virgin olive oil	160 °C
Butter	177 °C
Coconut oil	177 °C
Canola oil	204 °C
Virgin olive oil	216 °C
Sunflower oil	227 °C
Corn oil	232 °C
Peanut oil	232 °C
Rice oil	255 °C
Olive oil	242 °C

Cooking settings

Because the settings depend on the quantity and composition of the contents of the pan, the table below is intended as a guideline only.

- **Use setting 'boost' and setting 9 to:**
 - bring the food or liquid to the boil quickly;
 - 'shrink' greens;
 - heat oil and fat;
 - bring a pressure cooker up to pressure.
- **Use setting 8 to:**
 - sear meats;
 - fry flatfish;
 - fry omelettes;
 - fry boiled potatoes;
 - deep fry foods.
- **Use setting 7 to:**
 - fry thick pancakes;
 - fry thick slices of breaded meat;
 - fry bacon (fat);
 - fry raw potatoes;
 - make French toast;
 - fry breaded fish.

- **Use setting 6 and 5 to:**
 - complete the cooking of large quantities;
 - defrost hard vegetables;
 - fry thin slices of breaded meat.
- **Use settings 1-4 to:**
 - simmer bouillon;
 - stew meats;
 - simmer vegetables;
 - melting chocolate;
 - melting cheese.

Maintenance

Cleaning



Tip

Set the child lock before you start cleaning the hob.

Daily cleaning

- Although food spills cannot burn into the glass, we nevertheless recommend you clean the hob immediately after use.
- Best for daily cleaning is a damp cloth with a mild cleaning agent.
- Dry with kitchen paper or a dry tea cloth.

Stubborn stains

- Stubborn stains can also be removed with a mild cleaning agent such as washing-up liquid.
- Remove water marks and lime scale with vinegar.
- Metal marks (caused by sliding pans) can be difficult to remove. Special agents are available.
- Use a glass scraper to remove food spills. Melted plastic and sugar is also best removed with a glass scraper.



Don'ts:

- Never use abrasives. They leave scratches in which dirt and lime scale can accumulate.
- Never use anything sharp such as steel wool or scourers.

Troubleshooting

General

 **The service department telephone number can be found on the guarantee card provided.**

If you notice a crack in the glass top (however small), switch the hob off immediately, unplug the hob, turn off the (automatic) fuse switch(es) in the meter cupboard or, in the event of a permanent connection, set the switch in the power supply lead to zero.) Contact the service department.

Troubleshooting table

If the appliance does not work properly, this does not always mean that it is defective. Try to deal with the problem yourself first by checking the points mentioned below.

SYMPTOM	POSSIBLE CAUSE	SOLUTION
Symbols (–) appear in the displays when the hob is activated for the first time.	This is the standard set-up routine.	Normal operation
The fan runs on for several minutes after the hob has been switched off.	The hob is cooling.	Normal operation
A slight smell is noticeable the first few times the hob is used.	The new appliance is heating up.	This is normal and will disappear once it has been used a few times. Ventilate the kitchen.
You can hear a ticking sound in your hob.	This is caused by the capacity limiter on the front and back zones. Ticking can also occur at lower settings.	Normal operation.
The pans make a noise while cooking.	This is caused by the energy flowing from the hob to the saucepan.	At high settings this is perfectly normal for some pans. It will not damage either the pans or the hob.
You have switched a cooking zone on but the display keeps flashing.	The pan you are using is not suitable for induction cooking. or has a diameter of less than 12 cm.	Use a suitable pan.
A cooking zone suddenly stops working and you hear a signal.	The preset time has ended.	Switch the bleep off by pressing any key.
The hob is not working and nothing appears in the display.	There is no power supply due to a defective cable or a faulty connection.	Check the fuses or the electric switch (if there is no plug).

SYMPTOM	POSSIBLE CAUSE	SOLUTION
A fuse blows as soon as the hob is switched on.	The hob has been wrongly connected.	Check the electrical connections.
The hob simply switches off.	You accidentally touched the On/Off button or touched two buttons at the same time.	Switch the hob back on.
Fault code ER22.	The control panel is filthy or has water on it.	Clean control panel.
Fault code E2.	The hob has overheated.	Let the hob cool down and then use a lower setting.
Fault code U400	The voltage is too high and/or the hob is not properly connected.	Have your connection changed.
Fault code r' .	You held a button too long.	Do not hold the button too long.
Other fault codes.	Defective generator.	Contact the service department.

Installation instructions

What you need to consider

Safety instructions for the installation

- The connection must comply with national and local regulations.
- The appliance must always be earthed.
- This appliance may only be connected by a competent electrical installer.
- For the connection, use an approved cable in accordance with the regulations. The cable casing should be of rubber.
- The connection cable must hang freely and is not to be fed through a drawer.
- If you want to make a fixed connection, make sure that a multi-polar switch with a contact separation of at least 3 mm is fitted in the supply line.
- The worktop the hob is built into must be flat.
- The walls and the worktop surrounding the appliance must be heat resistant up to at least 85 °C. Even though the appliance itself does not get hot, the heat of the hot pan could discolour or deform the wall.
- Damage caused by incorrect connection, installation or use, will not be covered by the guarantee.

Clearance

Sufficient all-round clearance is essential to the safe use of the hob. Check that there is enough clearance.

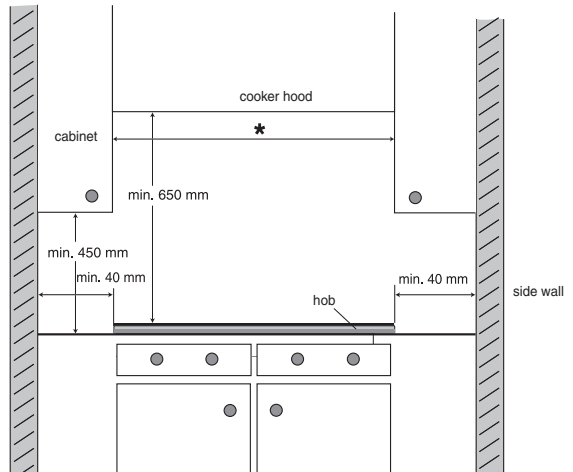

*SIVK 6 ... 61 cm

Installation dimensions

The dimensions and recesses are shown in the illustrations beneath.

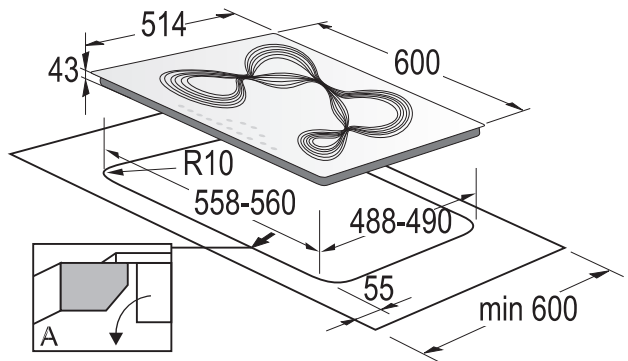

- Cooking hobs can be installed into worktops that are 30 to 50 mm thick.
- If the board is thicker than 40 mm, its inner edge should be trimmed, or ground. Thus, sufficient air circulation will be provided.

If the hob is wider than the cupboard, with a worktop less than 46 mm thick, saw a cut-out in both sides of the cupboard, so the appliance is detached from the cupboard.

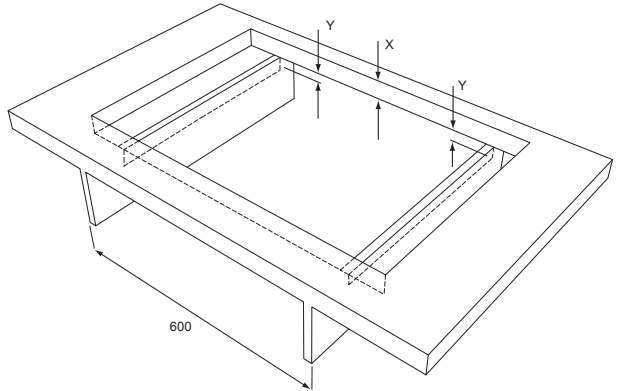

Installation dimensions inside the cabinet

$x < 46 \text{ mm}$: $y = 46 \text{ mm} - x$

$x \geq 46 \text{ mm}$: $y = 0 \text{ mm}$

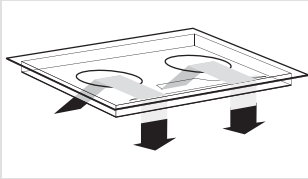

Ventilation

The electronics in the appliance need cooling. The appliance will automatically switch off if there is insufficient air circulation. There are ventilation openings on the underside of the appliance. It must be possible for cool air to be drawn in through these openings. There are outlet openings on the underside and at the front of the appliance.

A Lower kitchen cabinet with a drawer

- An opening at least 140 mm high must be provided on the back wall of the cabinet, along its entire width. Furthermore, a minimum of 6 mm clearance must be provided at the front side, along the entire width of the cabinet.
- The hob is fitted with a fan located in its lower part. In case there is a drawer underneath the kitchen cabinet, no small objects or paper must be kept there, as these could be sucked in by the fan, causing damage to the fan or the entire cooling system. Aluminum foil and inflammable substances or liquids (e.g. sprays) should also not be stored in such drawers or placed near the hob. Danger of explosion! There should be a clearance of 20 mm between the drawer contents and the fan entry slots.

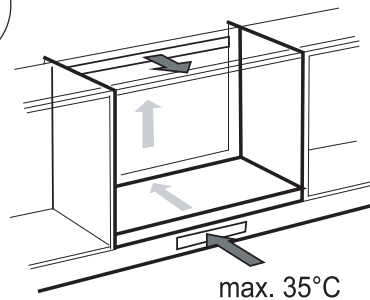
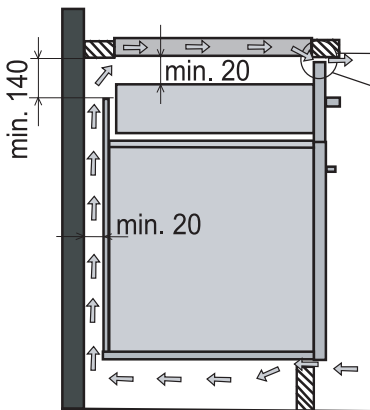

B Lower kitchen cabinet with an oven

- Installing the oven under an induction hob is possible with oven types EVP4.., EVP2.., which are fitted with a cooling fan. Before installing the oven, the rear wall of the kitchen cabinet should be removed. Furthermore, a minimum of 6 mm clearance should be provided at the front side, along the entire width of the cabinet.

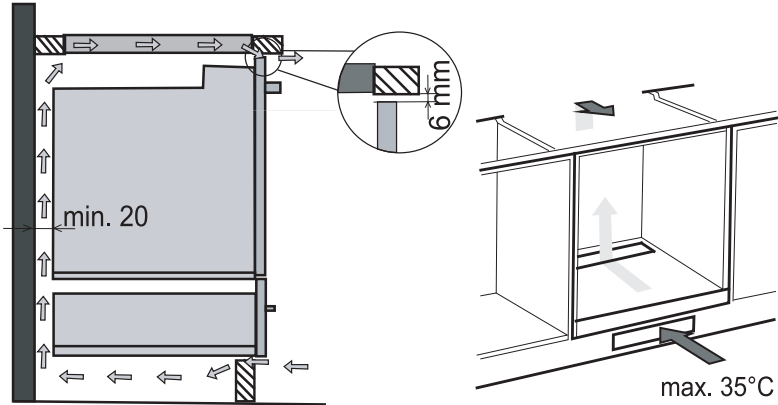

Electrical connection

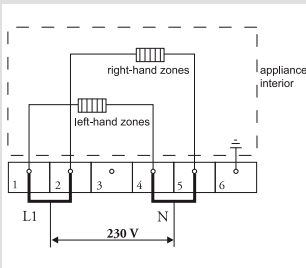
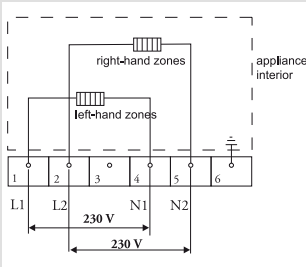
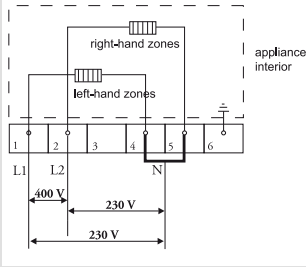

Common connection:

- 2 phase and 1 zero connection (2 1N, 400 V~/ 50 Hz):
 - The voltage between the phases and the zeros is 230 V~. The voltage between the two phases is 400 V~. Fit a connecting bridge between connecting points 4-5. The groups must have fuses of at least 16 A (2x). The core diameter of the connecting cable must be at least 2.5 mm².
- 2 phase and 2 zero connection (2 2N, 230 V~/ 50 Hz):
 - The voltage between the phases and the zeros is 230 V~.
 - The group must have fuses of at least 16 A (2x). The core diameter of the connecting cable must be at least 2.5 mm².

Special connections:

- Single phase connection (1 1N, 230 V~/ 50 Hz):
 - The voltage between the phase and the zero is 230 V~. Fit a connecting bridge between connecting points 1-2 and 4-5. The group must have a fuse of at least 32 A. The core diameter of the connecting should be at least 6 mm².

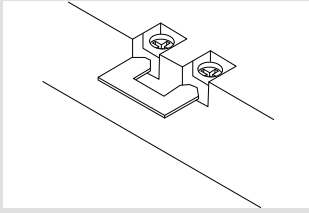

The bridges on the connecting block can be used to create the required connections, as indicated in these illustrations.

Building in

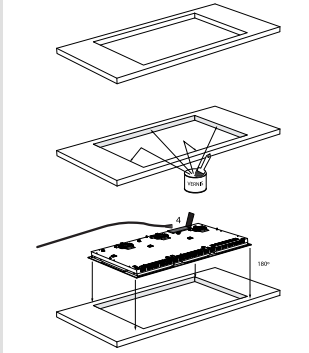

Check that the cabinet and the cut-out meet the dimension and ventilation requirement

Treat the sawn ends of wooden or synthetic worktops with sealing varnish if necessary, to prevent moisture causing the worktop to swell.

Lay the hob upside down on the worktop.

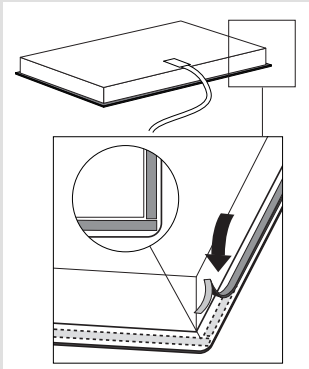

Fit the connecting cable to the appliance in compliance with requirements (see page 69 and 70).

Remove the protective layer from the sealing tape and apply the tape in the groove of the aluminium profile or on the edge of the glass plate. Do not stick tape round the corners, but cut 4 separate pieces to seal the corners well.

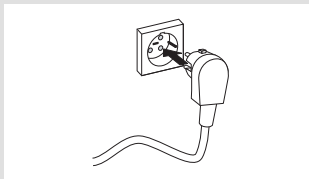

Turn the hob over and lay it in the recess.

Connect the appliance to the mains. A short bleep will be heard and all the displays will light up briefly. The appliance is ready for use.

Check that it works properly. If the appliance has been wrongly connected either a bleep will sound or nothing will appear in the displays, depending on the error.

G_5_KARIM RASHID



283199

en (01-14)