

**MT** **IE** **GB**

# Instructions for use, installation, and connection

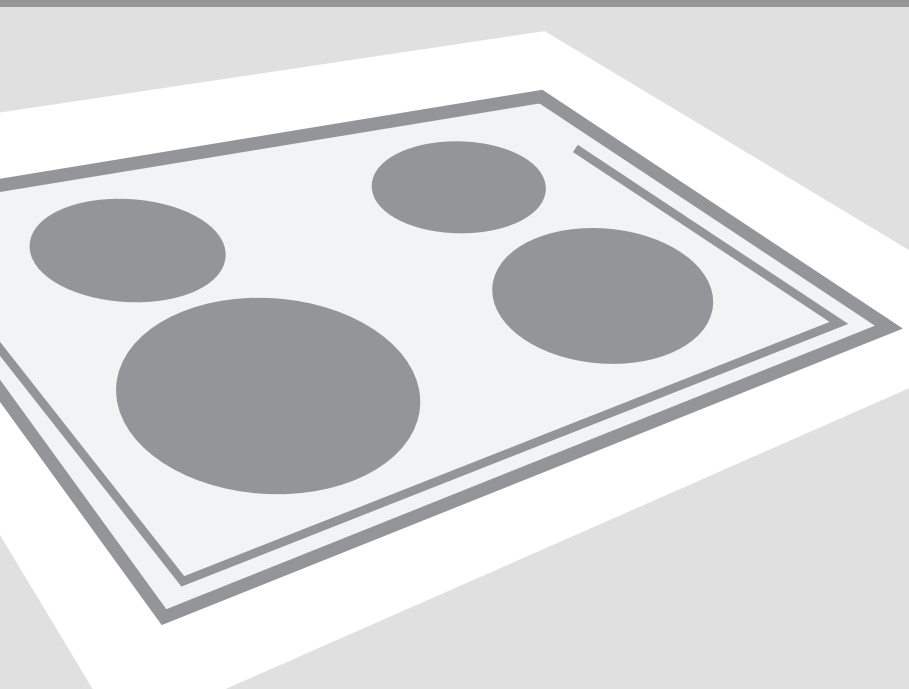

Combined and gas built-in cooking hob

# Combined and gas built-in cooking hob

## ***Dear customer!***



Combined and gas built-in hob is intended for use in households.

Our products are packed in environment-friendly materials which can be recycled, disposed of, or destroyed without imposing any burden on the environment.

## ***Instructions for use***

Instructions for use are intended for the user. They describe the appliance and its operation. The instructions apply to various types of appliances and may therefore include description of functions that may not be available on your appliance.

These instructions are only valid of the country symbol is indicated on the appliance. If there is NO county symbol in the appliance, technical instructions should be observed for adapting the appliance to comply with the requirements and regulations for use in your country.

## ***Instructions for connection***

The appliance must be connected in compliance with the instructions attached to it, as well as in compliance with relevant regulations and standards. The connection may only be performed by a qualified person.

## ***Rating plate***

The rating plate indicating the basic information on the appliance is attached to the lower side of the hob.

<b>Important - Read before using</b> .....	<b>3</b>
<b>the appliance</b> .....	<b>3</b>
<b>Appliance description</b> .....	<b>5</b>
<b>Cooking zones</b> .....	<b>6</b>
<b>Operating the electric cooking zones</b> .....	<b>9</b>
<b>Operating the gas burners</b> .....	<b>10</b>
<b>Cleaning and maintenance</b> .....	<b>11</b>
<b>Special warnings and fault reporting</b> .....	<b>12</b>
<b>Installation</b> .....	<b>13</b>
<b>Connecting the appliance to the power mains</b> .....	<b>16</b>
<b>Connecting the cooking hob to the gas supply</b> .....	<b>17</b>
<b>Nozzle table</b> .....	<b>20</b>
<b>Technical characteristics</b> .....	<b>21</b>

# Important - Read before using the appliance

## *Safety precautions*

- This appliance can be used by children aged from 8 years and above and persons with reduced physical, sensory or mental capabilities or lack of experience and knowledge if they have been given supervision or instruction concerning use of the appliance in a safe way and understand the hazards involved. Children shall not play with the appliance. Cleaning and user maintenance shall not be made by children without supervision.
- **WARNING:** The appliance and its accessible parts become hot during use. Care should be taken to avoid touching heating elements. Children less than 8 years of age shall be kept away unless continuously supervised.
- **WARNING:** Danger of fire: do not store items on the cooking surfaces.
- **WARNING:** Unattended cooking on a hob with fat or oil can be dangerous and may result in fire. Never try to extinguish a fire with water, but switch off the appliance and then cover flame with a lid or a damp cloth.
- Do not use steam cleaners or high-pressure cleaners to clean the cooking hob, as this may result in an electric shock.
- The appliance is not intended to be controlled by external timers or special control systems.

## *Warnings*

- The appliance may only be connected by an expert authorized by the gas distribution company or an authorized service center. All relevant legislation and local gas distributor's technical conditions for connection to the gas mains should be complied with. Important notes on connection are provided in the chapter »Instructions for connection.«
- Unauthorized service and repair can result in risk of explosion, electric shock, or short circuit and consequently personal injury and damage to the appliance. Such tasks may only be carried out by an authorized expert.
- Before installing and connecting the appliance, make sure the local connection conditions and characteristics (gas type and pressure) are compatible with the appliance set-up.
- The set-up of the appliance is specified on the rating plate.

- The appliance is not connected to a flue or a ventilation opening. The appliance should be installed and connected in compliance with the relevant regulations on connection. Heat, moisture, and combustion by-products are released during the use of the cooking appliance in the room where it is installed. Make sure your kitchen is adequately ventilated, especially during the use of appliance. Open all natural ventilation openings or install a mechanical ventilation device (a mechanical kitchen hood).
- The vertical distance between the appliance and the kitchen hood must be at least 650 mm or at least the distance specified in the instructions for installation of the kitchen hood.
- The appliance is intended solely for cooking. Do not use it for any other purpose, e.g. for room heating. Do not place empty cookware on the cooking zones.
- If another electrical appliance is connected to a AC power socket near the appliance, make sure the power cord does not come into contact with hot cooking zones.
- Do not store temperature-sensitive items underneath the appliance, such as cleaners or detergents, spray cans etc.
- Pay attention to correct installation of burner parts.
- If you smell gas in the room, immediately close the main inlet valve on the gas cylinder or the gas grid, extinguish any fire (including cigarettes), ventilate the room, do not switch on any electrical devices, and call a natural gas expert.
- Also close the main inlet valve if you do not intend to use the burners for a longer period of time (e.g. before leaving on vacation).
- In case of prolonged use of cast iron plates, the area of the plate and the edge of the cooking zone may discolour. Service in such case is not covered by the warranty.



**The symbol on the product or on its packaging indicates that this product may not be treated as household waste. Instead it shall be handed over to the applicable            collection point for the recycling of electrical and electronic equipment. By ensuring this product is disposed of correctly, you will help prevent potential negative consequences for the environment and human health, which could otherwise be caused by inappropriate waste handling of this product. For more detailed information about recycling of this product, please contact your local city office, your household waste disposal service or the shop where you purchased the product.**

# Appliance description

(equipment - depending on the model)

## Upper side of a combined cooker with gas and electric cooking zones

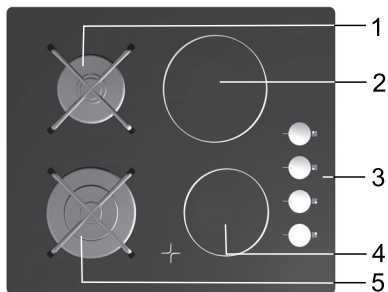

## Upper side of a combined cooker with gas cooking zones

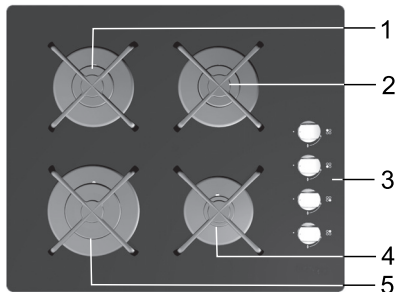

1. Cooking zone rear left
2. Cooking zone rear right
3. Control knobs
4. Cooking zone front right
5. Cooking zone front left

## Control knob

(depending on the model)

### Electric

	<p><b>1- 6</b></p>	<p>power levels</p>
--	--------------------	---------------------

### Gas

	<ul style="list-style-type: none"> <li>• gas valve is closed</li> </ul>	
	<ul style="list-style-type: none"> <li>🔥 maximum power</li> </ul>	
	<ul style="list-style-type: none"> <li>🔥 minimum power</li> </ul>	

## ***Before using the appliance for the first time***

## ***Important warnings***

## ***Cookware***

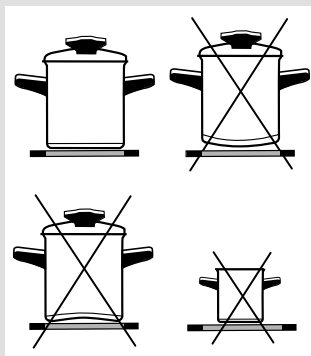

## **A) Electric cooking zones**

Turn on the cooking zones for 3 to 5 minutes and select the maximum power level; some fumes may be discharged from the hob. This way, the protective cover on the cooking hob will reach its maximum solidness.

- Do not turn on a cooking zone without a pan over it, and never use the cooking hob for room heating!
- Make sure the cooking zones and pan bottom are clean and dry, and that sufficient heat transmission is enabled between them, in order to prevent any damage to the heating surface.
- Any fat or oil left on the cooking ones may ignite. Therefore, be careful when using fat and oil to prepare food (e.g. French fries).
- Do not place a damp pan or a steam-covered lid on the cooking zones, as moisture is detrimental to them.
- Do not leave a hot pan to cool down on the cooking zones, because moisture will be generated under it, causing corrosion.

## **Tips for using the cookware**

Use high-quality cookware with a flat and stable bottom.

- Transmission of heat is best when the pan bottom and the cooking zone are of the same diameter, and the pan is placed on the middle of the cooking zone.
- When using a tempered glass (Pyrex) or porcelain cookware, please follow the cookware manufacturer's instructions.
- When using a pressure cooker, do not leave it unattended until the desired pressure is reached. The cooking zone should initially be set to the maximum power level; as the pressure rises, use the sensors to decrease the power level according to the pressure cooker manufacturer's instructions.
- Make sure there is always enough water, either in a pressure cooker or in any other piece of cookware, as using an empty pan on the cooking hob will result in overheating which will damage both the pan and the cooking zone.
- Tempered glass (Pyrex) cookware with a specially brushed bottom is suitable for use on cooking hobs if it fits the diameter of the cooking zone. Cookware with larger diameter may break due to thermal stress.
- When using any special or unconventional cookware, follow the cookware manufacturer's instructions.

## Energy saving

- Pan bottom diameters should match the diameter of the cooking zone. If the pan is too small, some heat is wasted; furthermore, using a too small pan can damage the cooking zone.
- Whenever possible given the cooking process, use a lid.
- The pan should be appropriately sized given the quantity of food prepared. Preparing a small quantity of food in a large pan will cause a waste of energy.
- Dishes that take a long time to cook should be prepared in a pressure cooker.
- Various vegetables, potatoes, etc., can be cooked in a small quantity of water; however, the lid should be closed tightly. When the water is brought to boil, reduce the power level to a setting that maintains a temperature just above boiling point.

## B) Gas cooking zones

- If you wish to quickly fry some food, set the gas burner to the maximum power initially and reduce the power as your continue.
- **With some models, gas burners are fitted with thermoelectric protection devices. If the burner flame is extinguished accidentally or unintentionally (e.g. when some liquid boils over or when there is draught in the room), gas supply is automatically cut off, thus preventing the gas to be emitted into the room.**
- **If the flame on a gas burner without thermoelectric protection, the gas will be emitted into the room!**
- Gas burner cover should always be placed very carefully on the burner crown. Make sure the slots on the burner crown are never obstructed.

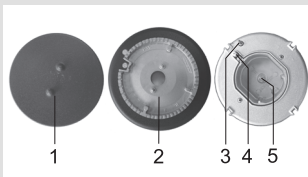

- 1 Burner crown cover
- 2 Burner crown with the support for the burner cover
- 3 Thermo-element (only with protected burners, available in some models)
- 4 Spark plug
- 5 Nozzle

## Important warnings

## Cookware

- Correctly selected cookware will enable optimum cooking time and gas consumption. Pan diameter is the most important parameter.
- Flames that reach over the edge of a pan that is too small, can damage the cookware; furthermore, gas consumption is higher in such cases.
- For combustion, the gas also needs air. If a pan is too large, air supply to the burner is insufficient; as a result, combustion effect is lesser.

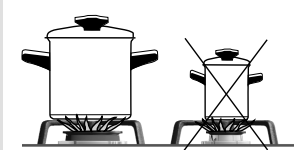

### Grid extension (only available with some models)

Use the extension when using a pan of a smaller diameter. Place the extension on the grid above the auxiliary burner.

Burner type	Pan diameter
Large (3,0kW)	220-260 mm
Normal(1,75kW)	180-220 mm
Auxiliary (1,0kW)	120-180 mm

### Important warnings regarding the glass ceramic hob

- Cooking zone reaches the selected power level or temperature very quickly; however, the area surrounding the cooking zones remains relatively cool.
- The hob is resistant to temperature changes.
- The hob is also impact-resistant. The pans may be placed onto the hob roughly without damaging the hob.
- Glass ceramic hobs should not be used as a worktop. Sharp objects can cause scratches.
- Preparing food in thin aluminum or plastic containers on hot cooking zones is not allowed. Do not place any plastic objects or aluminum foil on the glass ceramic hob.
- Never use a glass-ceramic hob that is cracked or broken. If an object falls on the hob with a sharp edge downwards, this could cause the hob / glass ceramic panel to break. The consequences are visible immediately, or only after a while. If any visible crack should appear, immediately disconnect the appliance from the power supply.
- If sugar is spilt on a hot glass ceramic hob, or a sugar-laden food, immediately wipe the hob.



# Operating the electric cooking zones

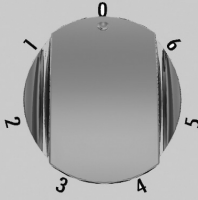

- Operate the cooking zones using the knobs, built into the control panels.
- When at least one cooking zone is turned on, the yellow LED is lit up.
- Power levels are indicated with the numbers from 1 to 6 on the control knobs. The respective levels are selected stepwise. The step knobs can be rotated in both directions.
- The cooking zone may be turned off three to five minutes before the end of cooking in order to make use of the residual heat and save some energy (the following table lists some examples for using individual power levels).

<b>S</b>	
<b>0</b>	Cooking zone turned off
<b>1</b>	Maintaining the temperature and reheating of smaller quantities of food
<b>2</b>	Reheating
<b>3</b>	Reheating or longer cooking of larger quantities
<b>4</b>	Consecutive cooking / frying (e.g. omelets etc.)
<b>5</b>	Deep frying
<b>6</b>	Quick heating

# Operating the gas burners

## Ignition and operation of the burners

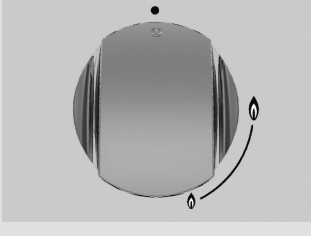

### Models with two gas burners:

- Operate the gas burners using the knobs on the hob. Power levels are indicated on the knobs by large and small flame symbols (see section Appliance description).
- Rotate the knob through the large flame position (🔥) to the small flame position (🔥) and back. Operation interval lies between the two flame symbols.
- Gas burners can be ignited using the electric spark plug built into each gas burner (only available with some models).

**⚠ Before rotating the knob, it should first be depressed.**

### Single-handed ignition

- In order to ignite the gas burner, press the selected burner control knob and rotate it to the maximum power (flame) position. An electric spark will be generated automatically, igniting the releasing gas.
- If the electric ignition should not work due to a power failure or damp spark plugs, the gas can also be ignited using a match or a gas lighter. After igniting the gas, keep the control knob pressed for another ten seconds, until the flame settles.
- The flame can then be set between the maximum and minimum level. Any setting between (🔥) and (●) is not recommended, as the flame is not stable in this interval and may be extinguished.

**⚠ If the burner hasn't ignited after the knob has been depressed for fifteen seconds, close the burner and wait at least one minute. Then, repeat the ignition process.**

**⚠ If the burner flame is extinguished (for any reason), close the burner and wait at least one minute before attempting to re-ignite it.**

- To extinguish the flame and close the burner gas supply, rotate the control knob to the right, to the 'OFF' position (●).

# Cleaning and maintenance

## Cleaning

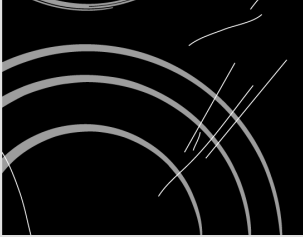

Figure 1



Figure 2



Figure 3



Figure 4

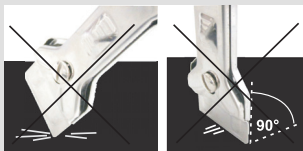

After each use of the **glass-ceramic hob**, wait for it to **cool down** and clean it; otherwise, even the smallest food residue will be burnt onto the hot surface next time you use the appliance. **For regular cleaning and maintenance of the glass-ceramic surface, use special conditioning agents** which form a protective layer on the surface, shielding it from dirt. Before each use, wipe any dust or other particles from the hob surface and pan bottom as these could scratch the surface (Figure 1).

**Careful:** steel wool, abrasive sponges, and abrasive detergents can scratch the hob surface. Glass ceramic surface can also be damaged by aggressive sprays and inappropriate or insufficiently shaken (mixed) liquid cleaning agents (Figure 1 and Figure 2).

**Signage** may be worn when using aggressive or abrasive cleaners or cookware with damaged bottom (figure 2).

**Light stains** can be removed by a damp soft cloth; then, wipe the surface dry (Figure 3).

**Water stains** can be removed using a mild solution of vinegar; however, do not use this solution to clean the frame (only with some models, as it may become dull. Do not use aggressive sprays or decalcification agents (Figure 3).

**Heavier stains** can be removed using special agents and utensils for cleaning the glass-ceramic hobs. When using these products, follow the instructions provided by their respective manufacturers.

**Make sure any residues of cleaning agents are thoroughly removed, as they could damage the glass-ceramic hob when the cooking zones heat up** (Figure 3).

Remove stubborn and burnt residues with a scraper (figure 4).

Be careful when handling the scraper to prevent injury.



**Only use the scraper when dirt cannot be removed with a wet cloth or special cleaners for glass ceramic surfaces.**

Hold the scraper at the **correct angle** (45° to 60°). **Gently press the scraper** against the glass and slide it over the signage to remove the dirt. Make sure the plastic handle of the scraper (in some models) does not come into contact with a hot cooking zone.



**Do not press the scraper perpendicularly against the glass and do not scratch the hob surface with its tip or blade.**

Sugar and sugar-laden food may permanently damage the glass-ceramic surface (Figure 5); therefore, they should be removed from the glass-ceramic surface as soon as possible, although the cooking zone may still be hot (Figure 4). **Any change in the color of the glass-ceramic surface** does not affect its operation or the stability of the surface. Such discolorations are mostly a result of burnt food

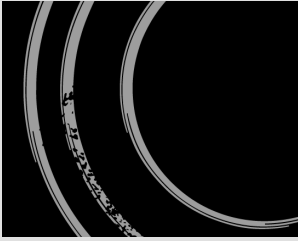

Figure 5

residues or use of cookware made of materials such as aluminum or copper; these stains are difficult to remove.

**Warning:** All damage described above predominantly relates to the aesthetics, i.e. appearance of the appliance and do not affect its functionality directly. Such errors cannot be the subject of a warranty claim.

## Gas cooking zones

To clean the grid, cooking hob surface, and parts of the burner, use hot water with some dishwashing detergent. Clean the thermo-element and the spark plug with a soft brush. These parts must be kept impeccably clean, as only then will they operate correctly. Clean the crown and the burner cover. Be particularly careful to keep all exit slots on the crown clean and unobstructed. After cleaning, dry all parts thoroughly and replace or reassemble them correctly.

**Parts that are placed askew will make lighting the burners more difficult.**

**Warning:** Burner covers are coated in black enamel. Due to high temperatures, discoloration is unavoidable; however, this will not affect the operation of the burners.

## Special warnings and fault reporting

**During the warranty period, only a service center authorized by the manufacturer may carry out any repairs.**

Before making any repairs, make sure the appliance is disconnected from the power mains either by removing the fuse or by disconnecting the power plug from the wall outlet.

Unauthorized tampering with and repairs of the kitchen range (cooking hob) can result in electric shock or short circuit; hence, do not attempt to perform any repairs by yourselves. Leave such tasks to an expert or an authorized service unit.

In case of minor faults or problems with the appliance operation, check the following instructions to see whether you can eliminate the causes by yourselves.

### **Important**

A visit by a service technician during the warranty period will be charged if the appliance is not functioning because of improper use. Store these instructions in a place where they are always readily accessible; if pass the appliance on to another person, the instructions should also be included.

Following is some advice on rectifying some common problems.

What happened...?	Possible cause	What to do?
The burners will not burn The flame is uneven / unstable	Flame is uneven due to a wrong gas power setting.	Have an expert check the gas pipeline!
The flame from the burners suddenly changes	Wrongly assembled parts of the kitchen hob	Assemble the burner correctly.
Burner ignition takes more time	Wrongly assembled parts of the kitchen hob	Assemble the burner correctly.
The flame is extinguished shortly after ignition	Knob pressed too short or too weakly.	Keep the knob depressed for a longer period of time. Before releasing it, press it harder.
The grid has discolored in the burner area?	This is a commonplace phenomenon resulting from high temperature	Clean the grid with a metal care detergent.
Electric power supply in general is interrupted?	The fuse may be blown.	Check the fuse in the fuse box and replace it if it is blown.
Electric ignition of the burners no longer works?	There are food or detergent residues between the spark plug and the burner.	Open and carefully clean the opening between the spark plug and the burner.
If the burner cover looks unappealing...	Regular dirt	Clean the burner covers with a metal care detergent.

If the problem persists despite observing the instructions above, call an authorized service technician. Elimination of any errors or warranty claims that resulted from improper connection or use of the appliance is not covered by our warranty. In such cases, the costs of repair are borne by the user.

## Installation

### **Important warnings**

- Installation of the appliance into a kitchen worktop and its connection to the power mains may only be performed by an adequately qualified technician.
- Veneer or other finish of the piece of kitchen furniture into which the hob is to be built in should be treated with heat resistant glue (100°C); otherwise, the worktop finish may be discolored or deformed.
- Cooking hob is dimensioned to be built into the worktop over a piece of kitchen furniture, with a width of 600 mm or more.
- After installation, the front two fastening elements should be freely accessible from below.
- The kitchen furniture element underneath the hob should not be fitted with a drawer. If the kitchen furniture element as a horizontal partition wall, it should be installed no less than 10 centimeters from the lower surface of the worktop. The space between the partition wall and the hob must be empty; no objects should be placed into that gap.
- Hanging, or wall-mounted kitchen elements should be installed high enough not to interfere with the work process.
- The distance between the cooking hob and the kitchen hood should be no less than indicated in the instructions for kitchen hood installation. The minimum distance is 650 mm.
- The distance between the appliance edge and the adjacent tall kitchen furniture element should amount to no less than 100 mm.

- Use of massive wood decoration plates or boards on the worktops behind the cooking hob is permitted, if the minimum distance remains the same as indicated in the installation drawings.
- Minimum distance between the built-in cooking hob and the rear wall is indicated on the installation drawing.
- Cooking hobs can be installed into worktops that are 30 to 50 mm thick.

### **Installing the foam gasket**

Before inserting the appliance into the opening in the kitchen worktop, the supplied foam gasket must be attached to the lower side of the glass ceramic (glass) cooking hob (see figure above).  
**Do not install the appliance without the foam gasket!**

**The gasket should be attached to the appliance in the following way:**

- Remove the protective film from the gasket.
- Then, attach the gasket to the lower side of the glass, approximately 2-3 millimetres from the edge (as shown in the figure). The gasket must be attached along the entire length of the glass edge and should not overlap at the corners.
- When installing the gasket, make sure that the glass does not come into contact with any sharp objects.

#### **NOTE!**

On some appliances the gasket is already installed!

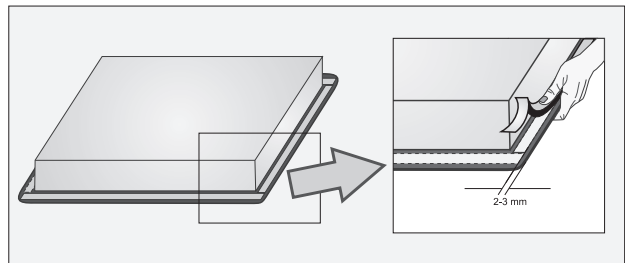

### **Kitchen worktop cutoff dimensions**

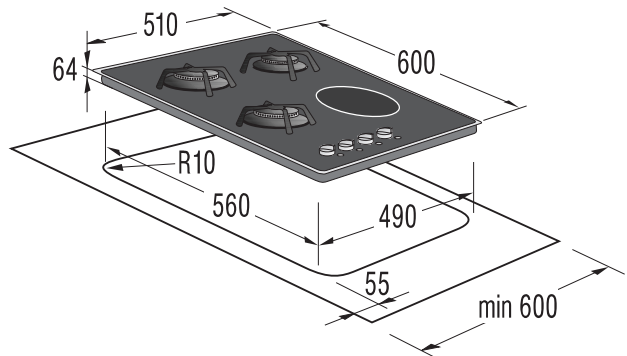

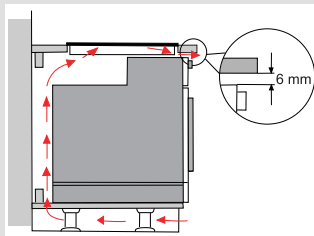

- Only type EVP4..., EVP2..., ovens fitted with a cooling fan may be installed underneath this cooking hob.
- Before installing an oven, the rear wall of the kitchen furniture element should be removed in the area of the cooking hob cutout. Furthermore, a gap of at least 6 mm should be left at the front side.

### **Installation procedure**

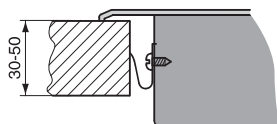
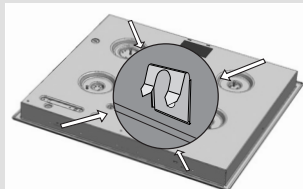

- The worktop should be installed completely horizontally.
- The cutoff surfaces should be appropriately protected.
- Attach the fastening elements (4) with the supplied screws (4) to the front and rear wall of the cooking hob and the worktop cutoff.
- Connect the cooking hob to the power mains and gas supply (see instructions for connecting a cooking hob on a power network and gas supply).
- Attach the supplied adhesive seal on the lower edge of the cooking hob.
- Insert the cooking hob into the cutoff and press it heavily from above towards the worktop.
- For screwing down the fixing clip it is not allowed to use screws longer than 6,5 mm.

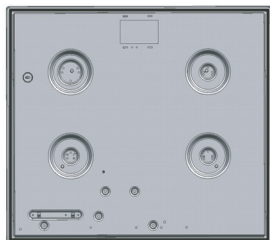

# Connecting the appliance to the power mains

## Important warnings

- The appliance may only be connected by an authorized skilled technician.
- Electric system protection should comply with all relevant regulations.
- The connection clips can be accessed when the connection clip covers are opened / removed.
- Before connecting the appliance, make sure the voltage indicated on the rating plate is consistent with the voltage in your home circuit.
- The rating plate with basic information is attached on the lower side of the hob.
- The electric circuit should also include an omnipolar switch that will separate the appliance from the mains, if required, with at least 3 mm of distance between contacts. Suitable devices include fuses, current protection switches, etc.
- The connection should be selected according to the installation possibilities with regard to current and fuses.
- Given the protection from the risk of fire, appliances of this type may be installed in a worktop next to a piece of kitchen furniture that is taller than the appliance (when installed); however, in this case, a kitchen furniture element must be installed on the other side, adjacent to the appliance.
- The current conducting and isolated parts must be protected from any possibility of direct contact.

## WARNING!

- Before any intervention, disconnect the appliance from the power mains. Connect the appliance in compliance with the electric connections diagram supplied; make sure the relevant network voltage is observed! The ground wire (PE) should be connected to the clip indicated by the earthing symbol.
- The mains cable should be fed through the fastening clip which protects it from being accidentally pulled out.
- After connecting the appliance, turn on all cooking zones / heaters for approximately three minutes to make sure they are operating correctly.

## Connection diagram

- Incorrect connection may destroy parts of the appliance, making the warranty void.
- Before connecting the appliance, make sure the voltage indicated on the rating plate is consistent with the voltage in your home network. Connection voltage (230 V through N) should be checked by a qualified technician using a corresponding measuring device!
- Connection cable on the back of the appliance should be led in such way that it does not touch the appliance back wall, as this part will get very hot during operation.

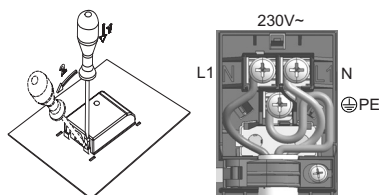



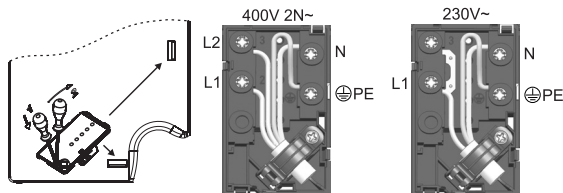

**NOTE:**

Connection bridges are already installed on their respective places on the clip. Screws of the connection terminals are open, which means they do not have to be unfastened or unscrewed any further. When fastening the screws, you may hear a slight ‘click’, which means that the screws should be fastened / screwed in completely.

The following can be used for connection:

- Type H05 RR-F 4×1.5 rubber connection cables with a green-yellow protective wire,
- Type H05 VV-F 4x1,5 PCV isolated connection cables with yellow-green protective wire, or other equivalent or superior grade cables.

## Connecting the cooking hob to the gas supply

### Important warnings

- The appliance must be connected in compliance with all relevant regulations, and it may only be used in well ventilated / aerated rooms. Before connecting or using the appliance, please read the instruction manual.
- Before installing and connecting, make sure the local natural gas supply network and connection (type of gas and pressure), are compatible with your appliance version.
- The version of this appliance is indicated on the rating plate.
- This appliance is not suitable for connection to a burning fumes exhaust system (i.e. a chimney). The appliance must be installed and connected in compliance with the relevant effective installation regulations. Special care must be taken to ensure adequate ventilation / aeration.

### Connection

- When connecting the appliance to the gas supply, follow the regulations of the local gas distributor.
- On the lower side, the cooking hob is fitted with a gas connection plug with a EN ISO 10226-1/-2 or EN ISO228-1 (Depending on the country-specific connection regulations.) thread.
- Also supplied with the appliance is an adapter for liquid gas and a non-metal gasket.
- When connecting, the knee R1/2 should be held firmly to prevent it from rotating.

- For sealing of the connection joints, use a non-metal approved gaskets and approved sealants.
- The gaskets should only be used once. The thickness of the flat non-metal gaskets should not be deformed more than by 25 percent.
- To connect the appliance to the gas supply, use a tested and certified flexible hose.
- The flexible connection hose should be able to move freely. It should not come into contact with the movable parts of the kitchen furniture (e.g. a drawer), or the bottom of the cooking hob.
- If an electric oven is built into the kitchen element under the cooking hob, it should be fitted with a cooling fan, and the connection should be made using a pipe completely made of metal (e.g. a stainless steel flexible pipe).

**⚠ After connecting the gas hob, check the joints for any leaks.**

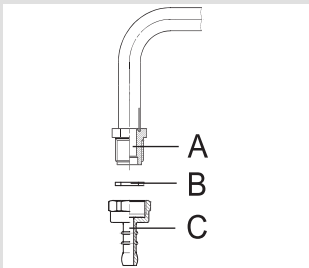

#### Gas supply connection plug

- A** EN ISO 10226-1/-2 or EN ISO228-1 (Depending on the country-specific connection regulations.) connection plug
- B** Non-metal gasket with thickness of 2 mm
- C** Pipe adapter for liquid gas (Depending on the country-specific connection regulations.)

After the connection, check the burners for correct operation. The flames must be clearly visible, and should be blue and green at the center. If the flame is unstable, increase the minimum power. Explain the use of the burners to the user and read the instructions for use together.

#### **Adaptation to a different type of gas**

- The procedure or adaptation of the cooker to another type of gas does not require removal of the appliance from the worktop.
- Before adapting, disconnect the appliance from the power mains and close the gas supply valve.
- Replace the existing nozzles for nominal thermal load with corresponding nozzles for the new gas type (see table below).
- When adapting the appliance to liquid gas, fasten the regulation screw for minimum thermal load as far as it will go, in order to attain minimum thermal load.
- When adapting the appliance to natural gas, release the minimum thermal load regulation screw in order to attain minimum thermal load, but do not rotate it by more than 1.5 turns.

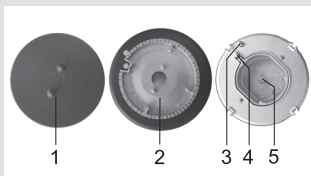

## Cooker burner

- 1 Burner crown cover
- 2 Burner crown with cover support
- 3 Thermo-element (only in protected burners, only available in some models)
- 4 Spark plug
- 5 Nozzle

## Adjustment elements

To leave the adjustment elements accessible, please observe the following instructions:

- Remove the support grid and burner covers with respective crowns.
- In double burners, adjustment elements are accessible behind the main nozzle protective plate.
- Remove the control knobs, including the gaskets.

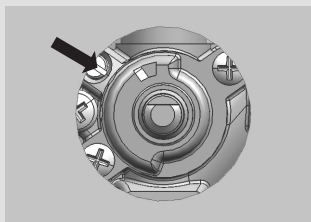

## Gas valve

Minimum thermal load regulation valve

## Nozzle table

gas type, pressure		Auxiliary burner		Normal burner		Large burner	
		max	min	max	min	max	min
Natural gas H Wo=45,7+54,7 MJ/m <sup>3</sup> , Natural gas E, Natural gas E+ Wo=40,9+54,7 MJ/m <sup>3</sup> G20, p=20mbar	Nom. therm. load (kW)	1	0,36	1,75	0,46	3	0,76
	Consumption (l/h)	95,21	34,4	166,62	4308	285,64	72,4
	Nozzle type (1/100mm)	72	*	97	*	115	*
	Nozzle code	690771		690772		690773	
Liquid gas 3+, 3B/P Wo=72,9+87,3MJ/m <sup>3</sup> G30 p=30 mbar	Nom. therm. load (kW)	1	0,36	1,75	0,46	3	0,76
	Consumption (l/h)	72,71	26,2	127,24	33,4	218,12	55,3
	Nozzle type (1/100mm)	50	29/24	65	33/26	85	43/33
	Nozzle code	690780		690781		690782	

- Regulation valves that are factory-built-in are intended for liquid gas; however, the valves are set for operation with the type of gas for which the appliance is factory-preset.
- When adapting the appliance for use with another type of gas, the regulation screw (valve) should be fastened or release to correspond with the required gas flow / throughput (however, the regulation screw should not be released more than by 1.5 rounds from the position in which it is completely fastened).

Burner power is indicated by observing the upper Hs calorific value.

**Warning: these tasks may only be carried out by a qualified technician, authorized by the gas distributing company or authorized service center!**

# Technical characteristics

## Rating plate

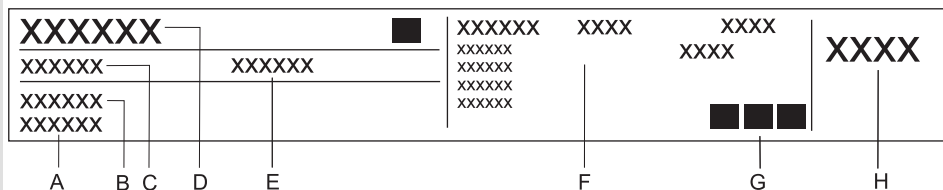

- A** Serial number
- B** Model
- C** Type
- D** Trademark
- E** Code
- F** Technical information
- G** Compliance indications / symbols
- H** Factory settings for gas type

WE RESERVE THE RIGHT TO MAKE ANY CHANGES THAT DO NOT AFFECT THE FUNCTIONALITY OF THE APPLIANCE.

Instructions for use of the appliance can also be found on our website at [www.gorenje.com](http://www.gorenje.com) / < <http://www.gorenje.com> / >





PVK,KVK62S



252585

en (01-14)