

MT **IE** **GB**

Instructions for use, installation, and connection



Gas freestanding cooker

Gas free standing cooker

Dear customer!



We sincerely thank you for your purchase. We believe you will soon find ample evidence that you can really rely on our products. To make the use of the appliance easier, we attach these comprehensive instruction manual.

The instructions should aid you in getting familiar with your new appliance. Please, read them carefully before using the appliance for the first time.

These instructions are only valid if the country symbol is indicated on the appliance. If there is NO country symbol in the appliance, technical instructions should be observed for adapting the appliance to comply with the requirements and regulations for use in your country.

In any case, please make sure the appliance was supplied to you undamaged. Should you identify and transport damage, contact your sales representative or the regional warehouse from where the product was delivered. You will find the telephone number on the receipt or delivery report. We wish you a lot of pleasure with your new household appliance.

Instructions for connection

The connection should be carried out in compliance with the instructions in the section "Connection to the power mains", and the relevant effective regulations and standards. This should only be performed by a qualified technician.

Rating plate

The rating plate indicating the basic information on the appliance is attached to the edge of the oven and it is visible when you open the oven door.

Important - Read before using the appliance	3
Appliance description	6
Cooking zones	8
Operating the gas burners.....	9
Gas oven	11
Food preparation.....	16
Cleaning and maintenance	24
Special warnings and fault reports.....	30
Installation and connection	32
Nozzle table	41
Technical characteristics.....	43

Important - Read before using the appliance

Safety precautions

- This appliance can be used by children aged from 8 years and above and persons with reduced physical, sensory or mental capabilities or lack of experience and knowledge if they have been given supervision or instruction concerning use of the appliance in a safe way and understand the hazards involved. Children shall not play with the appliance. Cleaning and user maintenance shall not be made by children without supervision.
- **WARNING:** The appliance and its accessible parts become hot during use. Care should be taken to avoid touching heating elements. Children less than 8 years of age shall be kept away unless continuously supervised.
- **WARNING:** Danger of fire: do not store items on the cooking surfaces.
- **WARNING:** Unattended cooking on a hob with fat or oil can be dangerous and may result in fire. Never try to extinguish a fire with water, but switch off the appliance and then cover flame with a lid or a damp cloth.
- Only use the temperature probe recommended for this oven.
- **WARNING:** Ensure that the appliance is switched off before replacing lamp to avoid the possibility of electric shock.
- Do not use harsh abrasive cleaners or sharp metal scrapers to clean the oven door glass since they can scratch the surface, which may result in shattering of the glass.
- Do not use steam cleaners or high-pressure cleaners to clean the cooking hob, as this may result in an electric shock.
- Before opening the cover, make sure it is clean and that there are now liquid residues on it. The cooker cover is lacquer coated and made of glass; it can only be closed once the cooking zones have cooled down completely. The symbol on the product or its packaging indicates that glass lids may shatter when heated. Turn off all the burners before lids may shatter when heated. Turn off all the burners before shutting the lid.
- The appliance is not intended to be controlled by external timers or special control systems.

Warnings

- The appliance may only be connected by an expert authorized by the gas distribution company or an authorized service center. All relevant legislation and local gas distributor's technical conditions for connection to the gas mains should be complied with. Important notes on connection are provided in the chapter »Instructions for connection.«
- Unauthorized service and repair can result in risk of explosion, electric shock, or short circuit and consequently personal injury and damage to the appliance. Such tasks may only be carried out by an authorized expert.
- Before installing and connecting the appliance, make sure the local connection conditions and characteristics (gas type and pressure) are compatible with the appliance set-up.
- The set-up of the appliance is specified on the rating plate.
- The appliance is not connected to a flue or a ventilation opening. The appliance should be installed and connected in compliance with the relevant regulations on connection. Heat, moisture, and combustion by-products are released during the use of the cooking appliance in the room where it is installed. Make sure your kitchen is adequately ventilated, especially during the use of appliance. Open all natural ventilation openings or install a mechanical ventilation device (a mechanical kitchen hood).
- This is a class 2/14 appliance. The appliance may touch the adjacent cabinets on both sides when placed in a row. On one side, a tall cabinet – taller than the appliance – may be placed at a distance of at least 10 cm from the appliance. On the other side, only a cabinet of the same height may be placed.
- The vertical distance between the appliance and the kitchen hood must be at least 650 mm or at least the distance specified in the instructions for installation of the kitchen hood.
- If the power cords of appliances located near this appliance are caught in the oven door, they can be damaged, which may in turn result in a short circuit. Therefore, keep the power cords of other appliances at a safe distance.
- The appliance is intended solely for cooking. Do not use it for any other purpose, e.g. for room heating. Do not place empty cookware on the cooking zones.
- Pay attention to correct installation of burner parts.
- If you smell gas in the room, immediately close the main inlet valve on the gas cylinder or the gas grid, extinguish any fire (including cigarettes), ventilate the room, do not switch on any electrical devices, and call a natural gas expert.
- Also close the main inlet valve if you do not intend to use the burners for a longer period of time (e.g. before leaving on vacation).
- Be particularly careful when cooking food in the oven. Due to high temperatures, baking trays, baking sheets, the grid and the oven interior walls become very hot. Always use oven mitts.
- Do not line the oven walls with aluminium foil and do not place baking trays or other cookware on the oven bottom. Aluminium foil would prevent air circulation in the oven, hinder the cooking process, and ruin the enamel coating.
- Oven door become very hot during operation. A third glass is installed or additional protection to reduce the temperature of the outside surface (only with some models).
- Do not store combustible, explosive, volatile or temperature-sensitive items (such as paper, dish cloths, plastic bags, cleaners or detergents and spray cans) in the oven's storage drawer, as they can ignite during over operation and cause a fire. Only use the appliance storage drawer to store equipment (baking sheet, drip tray etc.).
- Oven door hinges may be damaged if overloaded. Do not place heavy cookware on the open oven door and do not lean against the door while cleaning the oven. Before cleaning the oven, remove

the oven door (see chapter »Removing and re-installing the oven door«). Do not stand or sit on the open oven door (children!).

- In case of prolonged use of cast iron plates, the area of the plate and the edge of the cooking zone may discolour. Service in such case is not covered by the warranty.
- Appliance operation is safe with and without tray guides.
- The appliance is intended to be placed directly on the floor, without any supports or plinths.



The symbol on the product or on its packaging indicates that this product may not be treated as household waste. Instead it shall be handed over to the applicable collection point for the recycling of electrical and electronic equipment. By ensuring this product is disposed of correctly, you will help prevent potential negative consequences for the environment and human health, which could otherwise be caused by inappropriate waste handling of this product. For more detailed information about recycling of this product, please contact your local city office, your household waste disposal service or the shop where you purchased the product.

Appliance purpose

The appliance is intended for conventional preparation of food in households and should not be used for any other purpose. Individual options of use are comprehensively described in this instruction manual.

If you notice any faults on the gas pipeline, or if you smell gas in the room:

- Immediately shut down the gas supply or close the gas cylinder.
- Extinguish any flame, including cigarettes and other tobacco products.
- Do not turn on any electrical appliances (incl. the lights);
- Aerate the room thoroughly – open the windows!
- Immediately contact a service center or an authorized gas distribution company.

Appliance description

The figure represents one of the appliance models. Since a group of appliances to which these instructions apply, have different features, the instruction manual may describe functions and equipment that may not be available in your appliance.



- 1 Cooking hob cover (only with some models)
- 2 Vapor discharge opening
- 3 Area surrounding the cooking zones
- 4 Control panel
- 5 Oven door handle
- 6 Oven door
- 7 Cooker drawer
- 8 Additional support (only with some models)
- 9 Adjustable feet; accessible when the cooker drawer is removed (only with some models)

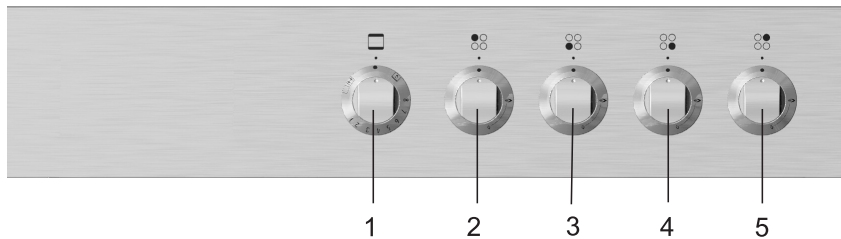

- 1 Operation mode selection knob and oven temperature setting
- 2 Cooking zone knob, rear left, normal burner
- 3 Cooking zone knob, front left, normal burner
- 4 Cooking zone knob, front right, large burner
- 5 Cooking zone knob, back right, auxiliary burner

Electric ignition (only with some models)

Gas cooking hob burners can be ignited using the electric ignition plug which is installed next to each burner. Electric ignition will only work if the mains cable is connected to the power supply network outlet. If the electric ignition is out of order due to a power supply failure or moist ignition plugs, burners can also be started using a match or a gas lighter. Oven burner is ignited in the same way.

Cooker cover (only with some models)

Before opening the cover, make sure it is clean and that there are now liquid residues on it. The cooker cover is lacquer coated and made of glass; it can only be closed once the cooking zones have cooled down completely.

The symbol on the product or its packaging indicates that glass lids may shatter when heated. Turn off all the burners before shutting the lid.

Extended operation of the cooling fan

After the oven is switched off, the cooling fan continues to operate for a while in order to additionally cool down the appliance.

Program timer

Set the time of day as described in the separate instructions for the program timer, supplied with your appliance. Setting the time of day is requisite for the use of the appliance. Oven operation is only possible once the time of day has been set.

Cooking zones

Before using the appliance for the first time

Important warnings

No particular measures or procedures are required prior to the first use of a gas hob.

- For quick browning, set the burner to the maximum power initially, and then continue cooking with minimum power.
- With some models, gas burners are fitted with thermoelectric protection devices. If the burner flame is extinguished accidentally or unintentionally (e.g. when some liquid boils over or when there is draught in the room), gas supply is automatically cut off, thus preventing the gas to be emitted into the room.
- If the flame on a gas burner without thermoelectric protection is accidentally extinguished, the gas will be emitted into the room!
- Gas burner cover should always be placed very carefully on the burner crown. Make sure the slots on the burner crown are never obstructed.

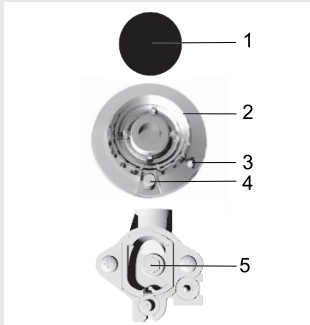

- 1 Burner crown cover
- 2 Burner crown with the support for the burner cover
- 3 Thermo-element (only with protected burners, available in some models)
- 4 Spark plug
- 5 Nozzle

Cookware

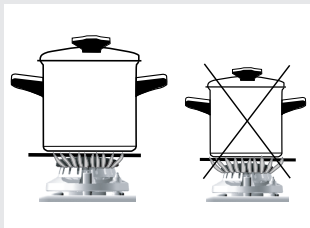

- Correctly selected cookware will enable optimum cooking time and gas consumption. Pan diameter is the most important parameter.
- Flames that reach over the edge of a **pan that is too small**, can damage the cookware; furthermore, gas consumption is higher in such cases.
- For combustion, the gas also needs air. If a pan is too large, air supply to the burner is insufficient; as a result, combustion effect is lesser.

Grid extension (only available with some models)

Use the extension when using a pan of a smaller diameter. Place the extension on the grid above the auxiliary burner.

Burner type	Pan diameter
Large (3,0kW)	220-260 mm
Normal (1,9kW)	180-220 mm
Auxiliary (1,0kW)	120-180 mm
Triple (3,5kW)	220-260 mm

Operating the gas burners

Control knob

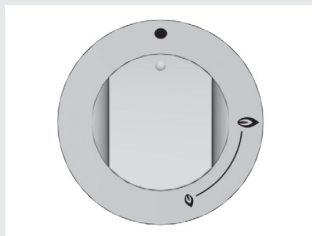

•	gas valve is closed
🔥	maximum power
🔥	minimum power

Ignition and operation of the burners (depending on the model)

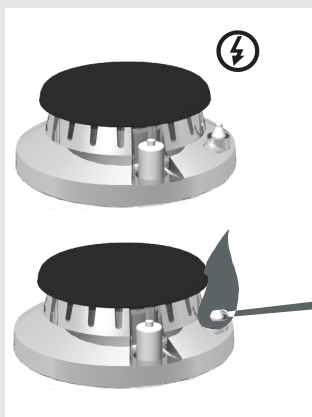

- Operate the gas burners using the knobs on the hob. Power levels are indicated on the knobs by large and small flame symbols (see section Appliance description).
- Rotate the knob through the large flame position (🔥) to the small flame position (🔥) and back. Operation interval lies between the two flame symbols.
- Gas burners can be ignited using the electric spark plug built into each gas burner (only available with some models).

⚠ Before rotating the knob, it should first be depressed.

Single-handed ignition

- In order to ignite the gas burner, press the selected burner control knob and rotate it to the maximum power (flame) position. An electric spark will be generated automatically, igniting the releasing gas.
- If the electric ignition should not work due to a power failure or damp spark plugs, the gas can also be ignited using a match or a gas lighter.

Two-handed ignition

- In order to ignite the gas burner, press the selected burner control knob and rotate it to the maximum power (flame) position. Then, press the ignition device button. An electric spark will be generated, igniting the releasing gas.
- If the electric ignition should not work due to a power failure or damp spark plugs, the gas can also be ignited using a match or a gas lighter. After igniting the gas, keep the control knob pressed for another ten seconds, until the flame settles.
- After ignition, keep the button depressed for the following 10 seconds, until the flame settles.
- The flame can then be set between the maximum and minimum level. Any setting between (⏏) and (●) is not recommended, as the flame is not stable in this interval and may be extinguished.

 **If the burner hasn't ignited after the knob has been depressed for fifteen seconds, close the burner and wait at least one minute. Then, repeat the ignition process.**

 **If the burner flame is extinguished (for any reason), close the burner and wait at least one minute before attempting to re-ignite it.**

- Note: While igniting the burners (applies to triple and double burner and the Mini Wok), the pans should already be placed on the grid over the burner.
- To extinguish the flame and close the burner gas supply, rotate the control knob to the right, to the 'OFF' position (●).

Gas oven

Before using the oven for the first time

Remove all accessories from the oven and clean them with warm water and a conventional detergent. Do not use abrasive cleaning aids.

When the oven is heated up for the first time, a specific odor of a “new appliance” will be discharged; therefore, ventilate the room thoroughly while the oven heats up.

Important warnings

- Do not cover the oven interior walls with aluminum and do not place any baking trays or other vessels on the oven bottom, as this will impede air circulation in the oven, hinder the cooking process, and destroy the enamel.
- The oven gas burner is thermoelectrically protected. If the burner flame is extinguished accidentally or unintentionally, the gas supply is automatically shut off.
- A thermostat regulates the oven temperature. Regulation is only possible if the oven door is closed.
- Oven door bottom panel must always be inserted when the oven is in operation.



Do not let the dishes to cool down in the oven, as this will cause the accumulation of condensate which may result in oven corrosion.

Operation modes (depending on the model)

- The oven is operated using the operation mode selection knob. When the knob is depressed towards the control panel, it can be rotated to the left (counterclockwise direction); when infra heater is in use, the knob can be rotated to the right (clockwise direction).

A) Conventional oven heating with gas

- With this mode of operation, the oven is heated with the oven gas burner.
- Cooking meat and pastry is only possible at one shelf level at a time.

Ignition and operation of the oven burner

- Press the oven control knob towards the control panel and rotate it to position . Simultaneously, press the ignition device button or approach an open flame (match, gas burner lighter) to the gas burner ignition opening, in order to ignite the gas.
- After ignition, keep the knob depressed for approximately 10 seconds, until the flame settles. Then, release the knob and set the desired heating power between 8 and 11.



⚠ If the burner hasn't ignited after the knob has been depressed for fifteen seconds, close the burner and wait at least one minute. Then, repeat the ignition process.



⚠ If the burner flame is extinguished (for any reason), close the burner and wait at least one minute before attempting to re-ignite it.

- Oven temperature is controlled by a thermostat. Immediately after ignition, the burner operates at full power; when the set temperature is reached, the thermostat automatically decreases the burner power to the level required to maintain the set temperature.
- Regulation will only work if the oven door is closed.
- To turn off the oven burner, rotate the button back to position (●).

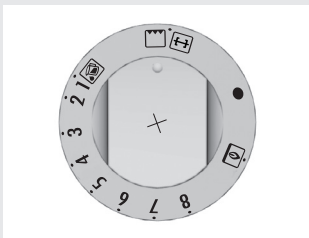
Setting	Temperature °C
●	gas valve is closed
8	280
7	260
6	240
5	220
4	200
3	180
2	160
1	150



B) Heating with the gas infra burner

- With this operation mode, the infra burner heats the food by radiating the heat, thus enabling grilling. This burner is installed just under the oven interior (chamber) ceiling.
- During operation, of the infra burner, the oven thermostat does not operate – infra burner is operating at full power all the time; therefore, oven door must be opened or removed, and a control panel protection plate should be installed underneath it (stick the protection panel under the control panel attachment screws).
- Control the infra burner with the oven 7 grill control knob. Position  is the operating position of the infra burner. Knob positions between ● and  are not allowed, as the flame is not stable in this area and may be extinguished.
- Press the oven control knob towards the control panel and rotate it to position . Simultaneously, press the ignition device button or approach a lit match or gas burner lighter to the infra burner in order to ignite the gas.

- After ignition, keep the knob depressed for 10 seconds, until the flame settles; then, release it. The time between the start of gas release and ignition should be as short as possible.

⚠ If the burner hasn't ignited after the knob has been depressed for fifteen seconds, close the burner and wait at least one minute. Then, repeat the ignition process.

⚠ If the burner flame is extinguished (for any reason), close the burner and wait at least one minute before attempting to re-ignite it.

- Extinguish / turn off the oven burner by rotating the knob back to position (●). The gas valve is shut and the burner flame is extinguished.



C) Grill (electric infra heater)

- In this mode of operation, the heat is radiated by the electric infra heater which is installed under the oven interior ceiling.
- This operating mode is particularly appropriate for roasting smaller chunks of meat such as beef steaks, grill sausages, other steaks, cutlets, etc.
- The grill can also be used for spit-roasting chicken (only with some models).
- Press the operation mode selection knob towards the control panel and rotate it to the right, to the grill / spit-roasting symbol. The grill heater and the spit-roasting mechanism (only with some models) are activated.
- Cooking temperature when grilling amounts to 240°C. When this temperature has been reached, the heater is switched off, and remains off until the temperature drops below 240°C. Current operation of the electric grill heater is indicated by a red control light.

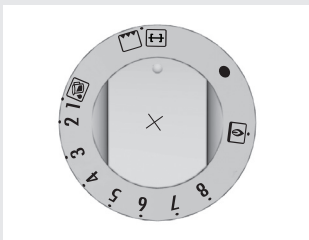

Shelf levels

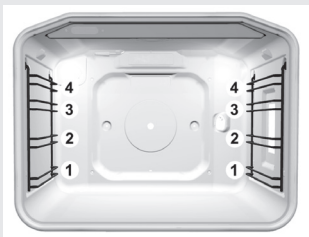

Oven accessories (the grid, aluminum baking tray, deep baking tray) can be inserted into the oven at four height levels. Each level is described in the cooking tables (see section Food preparation).

⚠ Please note that the shelf levels are always referred to from bottom up.

Note: The deep tray, or the drip tray, cannot be inserted into the first, lowermost guide.

**Easy-clean inserts
(depending on the
model)**

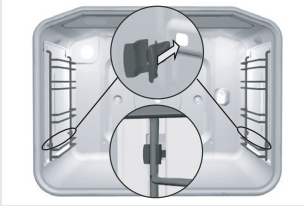
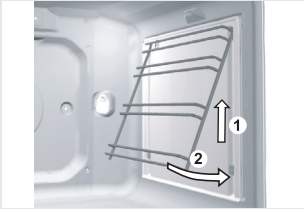
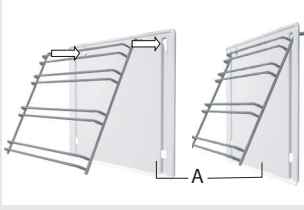

The easy-clean inserts prevent the fat from splattering directly on the oven wall.

The easy-clean inserts are installed as follows:

The easy-clean inserts are installed as follows:

- Remove the wire guides (see section on wire guides).
- Attach the guides (wire or telescopic) to the easy-clean shield (A). Then, hang them together by sliding the two prongs into the provided hole and pulling the assembly downward.

When installing the easy-clean inserts, insert the four retainers into the lower openings on the oven wall; insert the guides into the retainers. Retainers are intended to additionally fix the guides.

**Oven lighting
(depending on the
model)**

Oven lighting may be turned on and off by pressing the oven lighting switch installed on the control panel.

**Oven accessories
(depending on the model)**

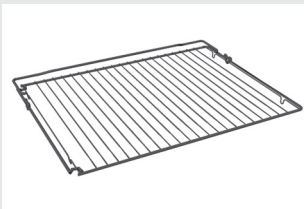

The grid onto which the container with food, or the food directly, is placed.



A safety stop is fitted on the grid and on the guides. To pull out the grid, lift it slightly when it hits the stop.

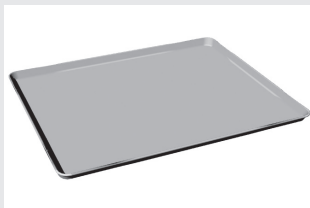

Low baking tray made of bright metal sheet is intended only for baking pastry and cupcakes. Place the tray on the middle of the grid and push it towards the oven back wall (to the flange on the grid).



The shallow enamel-coated tray is not appropriate for baking pastry; it is used as a drip tray for catching the fat dripping of the food (insert it in the lower, i.e. 1st or 2nd guide).



Warning: The shallow enamel-coated baking tray can be inserted into the 1st or 2nd guide when grilling food and when it is used as a drip tray. The shallow enamel-coated baking tray is not appropriate for baking pastry.



Deep baking tray is intended for baking meat and moist pastry; it is also intended as a drip tray.



The extra deep baking tray is intended for cooking large amounts of food (meat, vegetables, pastry).



Do not attempt to insert the deep baking tray into the first guide.

Baking pastry

The following table lists the information on recommended temperature, duration, and shelf level when baking pastry.

Baking with conventional gas oven heating

- Use only one height level at a time.
- Use light-colored tins and trays to bake pastry. Dark-colored tins and trays are not recommended as they absorb too much heat from the oven burner.
- Do not use tins that are too high, as this may prevent the pastry from being cooked evenly.
- Always place the tins and baking trays on the grid, making sure they do not reach over the edge of the grid.
- For appliances with four height levels: only use the second and third guide from the bottom for baking. Use the second level to bake all kinds of pastry and cupcakes.

Tips on baking pastry

Is the pastry completely done? Use a wooden stick to pierce the pastry at the highest point. If there are no traces of dough when the stick is removed, the pastry is done. Turn off the oven and use the remaining accumulated heat.

The pastry has collapsed

Check the recipe. Next time, use less liquid. Observe the instructions on mixing / kneading time, especially when using small household appliances.

The pastry with a moist filling (e.g. cheesecake) is not completely done

Next time, reduce the temperature and extend the cooking time.



Use light-colored baking trays to bake pastry.

Notes on the pastry baking table:

- Cooking times are given as an estimate and may vary subject to a number of circumstances.
- The indication * means that the oven should be preheated with the corresponding operating mode selected.
- We recommend selecting a shorter cooking time initially; if required, increase the temperature later on, if you want your pastry browner, or if you feel it has been cooking for too long.
- When using baking paper, make sure it is resistant to high temperature.
- If you can't find a certain type of pastry in the cooking table, look for one that is similar.

Type of pastry	Guide (from the bottom)	Temperature (°C)	Cooking time (minutes)
Sweet pastry			
Marble cake, ring cake	2	180-190	50-70
Rectangle-shaped cake	2	180-190	60-75
Cake made in cake tin	2	180-190	45-60
Cake tin cheesecake	2	180-190	60-90
Fruit cake, short pastry	2	190-200	50-70
Fruit cake with dressing	2	180-190	60-70
Sponge cake*	2	190-200	30-40
Cake with icing	2	200-210	25-35
Fruit cake, mixed dough	2	190-200	50-70
Cherry cake	2	180-200	35-50
Sponge cake roll*	2	220-230	18-25
Leavened dough cake	2	190-200	25-35
Hefezopf (leavened dough)	2	180-190	25-45
Christmas cake	2	170-180	40-60
Apple pie	2	190-200	50-70
Oven-baked donuts	1	190-200	40-60
Savory pastry			
Quiche Lorraine	1	200-210	50-60
Pizza*	2	200-220	30-45
Bread*	2	170-180 240-250	15-20 45-50
Bite-size pastry			
Short pastry – cookies	2	190-200	15-30
Merengue	2	200-210	15-25
Leavened dough	2	200-210	35-50
Puff pastry	2	200-210	20-40
Choux pastry (cream filled)	2	200-220	25-45
Frozen pastry			
Apple, cheese pie	2	190-200	60-75
Cheesecake	2	180-190	70-90
Pizza	2	200-220	20-30
French fries for oven*	2	200-220	20-35
Croquettes	2	200-220	20-35

Setting	1	2	3	4	5	6	7	8
Temperature (v °C)	150 °C	160 °C	180 °C	200 °C	220 °C	240 °C	260 °C	280 °C

The following table lists the information on recommended temperature, duration, and shelf level when cooking meat.

Tips on the use of cookware

- Meat can be cooked in enamel coated cookware, tempered glass (Pyrex) cookware, clay, or cast iron cookware. Stainless steel baking trays are less appropriate because they reflect the heat.
- If the roast is covered, it will remain juicier, and the oven will not be as dirty.
- In an open baking tray, the roast will brown sooner.
- For very large chunks of roast, it is recommended to insert the grid and the deep baking tray to catch the dripping fat.

Notes to the meat cooking table

- The meat cooking table lists the information on recommended temperature, duration, and shelf level when cooking meat. Since cooking times depend heavily on the type, weight, and quality of the meat, certain deviations can occur.
- Cooking meat, poultry, and fish in an oven is economical only at weights exceeding 1 kg.
- When cooking meat, add enough liquid to prevent the fat and juices from the meat to be burnt onto the baking tray. This means that, in case of longer cooking times, the roast should be checked upon every one in a while, and liquid should be added.
- After approximately half of cooking time, turn the roast around, especially when baking in a tray. For better results, start the cooking with the upper side turned downwards.
- When cooking larger chunks of meat, condensate may accumulate on the oven door. This is a natural phenomenon which does not affect the operation of the appliance. After cooking, wipe the door and door glass dry.
- In order to prevent accumulation of condensate, do not let the dishes to cool down in the oven.

Type of meat	Weight (g)	Guide (from bottom)	Temperature (v °C)	Cooking time (min.)
Beef				
Beef roast	1000	2	200-220	90-120
Beef roast	1500	2	190-210	120-150
Roastbeef, medium done	1000	2	210-230	30-40
Roastbeef, well done	1000	2	210-230	40-50
Pork				
Pork roast, incl. skin	1500	2	180-190	140-160
Pork belly	1500	2	190-200	120-150
Pork belly	2000	2	180-190	150-180
Shoulder	1500	2	200-210	120-140
Pork roll	1500	2	200-210	120-140
Cutlet	1500	2	180-200	90-120
Minced meet roast (pork meat loaf)	1500	2	210-220	60-70
Veal				
Veal roll	1500	2	190-200	90-120
Veal joint	1700	2	180-200	120-130
Lamb				
Lamb loin	1500	2	190-200	100-120
Sheep joint	1500	2	190-200	110-130
Venison				
Rabbit loin	1500	2	190-200	100-120
Deer joint	1500	2	190-200	100-120
Wild boar joint	1500	2	190-200	100-120
Poultry				
Chicken, whole	1200	2	200-220	60-70
Chicken	1500	2	200-210	70-90
Duck	1700	2	180-200	120-150
Goose	4000	2	160-180	180-200
Turkey	5000	2	150-160	180-240
Fish				
Whole fish	1000	2	200-210	50-60
Fish soufflé	1500	2	180-200	45-65

Setting	1	2	3	4	5	6	7	8
Temperature (°C)	150 °C	160 °C	180 °C	200 °C	220 °C	240 °C	260 °C	280 °C

Grilling with the gas infra heater (only with some models)

- Hot fat may squirt out of pierced meat (e.g. from sausages). To avoid burning your skin or eyes, use meat tongs.
- When grilling meat, control the process at all times. Due to high temperature, meat can be burnt quickly!
- Do not let children anywhere near the grill. Grilling process should be constantly controlled; due to high temperatures, the dish may even catch fire.
- Roasting with infra heater is recommended for crisp and low-fat

preparation of grilled sausages, meat chunks, and fish (steak, chops, salmon fillets, etc.) or toasted bread, as well as for browning.

Some tips on using the grill function

- When using the grill, oven door should always be open.
- Install the control panel protection plate.
- During grilling, the oven thermostat is deactivated and the infra heater is operating at full power all the time.
- The cooking table for grilling indicates recommended temperature, guide level, and cooking time. Since cooking time depends strongly on the type, quality, weight, and quality of meat, an interval of recommended durations is given.
- The grill heater should be pre-heated for three to five minutes with the oven empty and the door open.
- When cooking on a grid, spread some oil over it to prevent the meat from sticking onto it.
- When grilling meat, insert the grid with the food into the corresponding guide, and insert the deep tray as the drip tray one guide lower.
- The food to be grilled should be placed on the middle of the grid, under the infra heater.
- Grilled meat should be turned halfway through the cooking. Thinner slices of meat should only be turned once, while the thicker ones should be turned several times.
- Use meat tongs to turn the meat around, to prevent piercing the meat and losing too much juice.
- Darker meat will brown better and sooner than pork or veal.
- After using the grill, clean the oven and accessories each time.

Spit-roasting under the gas infra heater (only with some models)

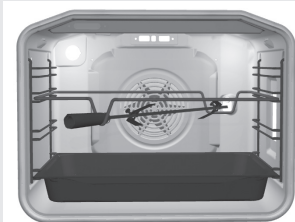

- When spit-roasting, you are using the grill (infra heater); therefore, extra care is required. Use a thick kitchen glove and a special handle that is screwed onto the spit.
- Very hot fat can squirt out of a piece of spit-roasted meat. To prevent injury to the skin and the eyes, use meat tongs.
- Do not let children anywhere near the oven while spit-roasting.
- The spit-roast is appropriate for crispy and low-fat preparation of young poultry.

Some tips on spit-roasting

The rotating roast spit set consists of a rotating spit with a detachable handle and two forks with screws for fixing the meat chunk.

- When using the spit-roast set, oven door should always be open.
- Install the control panel protection plate.
- During grilling, the oven thermostat is deactivated and the infra heater is operating at full power all the time.

- When spit-roasting, preheating is not required.
- When using the roast spit, first insert the special support frame into the third guide from the bottom.
- Spit the seasoned meat and stick the support forks into the meat chunk from each side to firmly fix it. Then, tighten the screws on the forks.
- Install the handle on the front part of the roast spit. Stick the pointed part of the spit into the opening on the right side of the back oven door, which is protected by a rotating shutter. Place the front part of the spit into the lowest part of the support frame until it snaps into place.
- Insert a deep tray, which will serve as a drip tray in this case, into the first guide.
- Before the start of roasting, detach the spit handle.
- During spit-roasting, the spit will rotate the entire time while the infra heater is in operation.
- After the end of grilling, reattach the spit handle. When removing the spit, use a thick kitchen cloth. After each use, clean the oven and the accessories.

Food type	Weight (g)	Guide level (from bottom)	Cooking time (min.)
Meat and sausages			
2 fillet mignon steaks	400	3	25-30
2 pork neck steaks	350	3	25-30
2 cutlets	400	3	25-30
4 lamb cutlets	700	3	18-22
4 grill sausages	400	3	18-23
2 minced meat steaks	400	3	15-20
1 chicken, split in halves	1400		35-45 (one side) 25-35 (other side)
Fish			
Salmon fillets	400	3	15-20
Fish in aluminum foil	500	3	15-20
Toasted bread			
4 slices of white bread	200	3	5-7
2 slices of mixed flour bread	200	3	6-8
Toasted sandwiches	600	3	6-9

Grilling with the electric infra heater (position 0) (only with some models)

- When grilling meat, you should be particularly careful. The high temperatures and infra heater heat the grid and other parts of the oven to very high degrees. Hot fat may squirt out of pierced meat. To avoid burning your skin or eyes, use a kitchen glove and meat tongs.
- Do not let children anywhere near the grill. Control the grilling process at all times. Due to high temperatures, the food may even catch fire!
- Grilling with infra heater is recommended for crisp and low-fat preparation of grilled sausages, meat chunks, and fish (steak), as well as or toasted bread and food that requires browning on the upper side (lasagna, potatoes, deserts).

Some tips on using the grill function

- When using the grill, oven door should always be closed.
- The cooking table for grilling indicates recommended temperature, guide level, and cooking time. Since cooking time depends strongly on the type, quality, weight, and quality of meat, it is given in a recommended interval.
- The infra heater should be preheated for five minutes.
- When cooking on a grid, spread some oil over it to prevent the meat from sticking onto it.
- When grilling, insert the grid with the food into the corresponding guide; then, Insert a deep tray, which will serve as a drip tray in this case, one level lower.
- Grilled meat should be turned halfway through the cooking. Cook the first side somewhat longer than the other one. Thinner slices of meat should only be turned once, while the thicker ones should be turned several times. Use meat tongs to turn the meat around, to prevent too much juice to be lost.
- Darker meat will brown better and sooner than pork or veal.
- After using the grill, clean the oven and accessories each time to prevent the dirt to be burnt onto the oven the ext time you use it.

Spit-roasting with the electric infra heater (only with some models)

- When spit-roasting, you are using the grill (infra heater); therefore, extra care is required. Use a thick kitchen glove and a special handle that is screwed onto the spit.
- Very hot fat can squirt out of a piece of spit-roasted meat. To prevent injury to the skin and the eyes, use meat tongs.
- Do not let children anywhere near the oven while spit-roasting.
- The spit-roast is appropriate for crispy and low-fat preparation of young poultry.

Some tips on spit-roasting

- The rotating roast spit set consists of a rotating spit with a detachable handle and two forks with screws for fixing the meat chunk.
- When using the spit-roast set (with the electric infra heater), oven door should always be closed.
- Infra heater / grill heater does not require any preheating.
- When using the roast spit, first insert the special support frame into the third guide from the bottom.
- Spit the seasoned meat and stick the support forks into the meat chunk from each side to firmly fix it. Then, tighten the screws on the forks.
- Install the handle on the front part of the roast spit. Stick the pointed part of the spit into the opening on the right side of the back oven door, which is protected by a rotating shutter. Place the front part of the spit into the lowest part of the support frame until it snaps into place.
- Insert a deep tray, which will serve as a drip tray in this case, into the first guide.
- Before the start of roasting, detach the spit handle.
- During spit-roasting, the spit will rotate the entire time while the infra heater is in operation.
- After the end of grilling, reattach the spit handle. When removing the spit, use a thick kitchen cloth.
- After each use, clean the oven and the accessories.

Type of food	Weight (g)	Guide level (from bottom)	Temperature (°C)	Cooking time (min.)
Meat and sausages				
2 fillet mignon steaks	400	3	240	20-23
2 pork neck steaks	350	3	230-240	20-23
2 cutlets	400	3	230-240	20-23
4 lamb cutlets	700	3	240	14-16
4 grill sausages	400	3	240	15-18
2 minced meat steaks	400	3	240	12-16
1 chicken, split in halves	1400	2	230-240	28-33 (one side) 23-28 (other side)
Fish				
Salmon fillets	400	3	240	10-15
Fish in aluminum foil	500	3	240	10-13
Toasted bread				
4 slices of white bread	200	3	240	1-3
2 slices of mixed flour bread	200	3	240	2-3
Toasted sandwiches	600	3	240	5-7

Cleaning and maintenance

Do not use a steam cleaner or a high-pressure steam cleaner to clean the appliance. Before you start cleaning the appliance, disconnect it from the power mains and let it cool down.

Appliance housing front

Clean the surfaces with liquid non-abrasive detergents intended for smooth surfaces, and a soft cloth. Apply the detergent on the cloth and wipe off the dirt; then, rinse with water. Do not apply the detergent directly on the surfaces. Do not use aggressive or abrasive cleaners, sharp objects or steel wool, as these will scratch the appliance.

Stainless steel front panels (only with some models)

Clean the surface with a mild cleaner (soapsuds) and a soft sponge that will not scratch the material. Do not use abrasive or solvent-based cleaners. If these instructions are ignored, the housing surface can be damaged.

Lacquer-coated and plastic surfaces

Clean the buttons / knobs and the door handle with a soft cloth and liquid detergents intended for cleaning smooth lacquer-coated surfaces. You may also use the cleaners made especially for this type of surfaces; in this case, follow the manufacturer's instructions.

WARNING: The above surfaces should never come into contact with oven cleaning sprays, as these will permanently damage the aluminum parts.

Do not clean the **aluminum baking tray** with abrasive cleaners, as these will leave scratches. If it is cleaned often, the baking tray will lose its glow. This cannot be prevented; however, it does not affect the baking / cooking results.

Special enamel

The oven and interior side of the oven door are coated with special enamel that has a smooth and highly resistant surface. This special layer facilitates cleaning at room temperature.

Cleaning

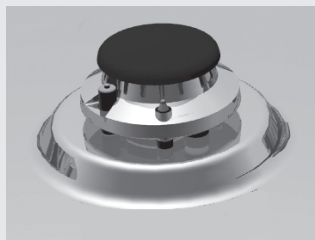

Gas cooking zones

- To clean the grid, cooking hob surface, and parts of the burner use hot water with some dishwashing detergent. Do not clean in a dishwasher.
- Clean the thermo-element and the spark plug with a soft brush. These parts must be kept impeccably clean, as only then will they operate correctly.
- Clean the crown and the burner cover. Be particularly careful to keep all exit slots on the crown clean and unobstructed.
- After cleaning, dry all parts thoroughly and replace or reassemble them correctly. Parts that are placed askew will make lighting the burners more difficult.

Warning: Burner covers are coated in black enamel. Due to high temperatures, discoloration is unavoidable; however, this will not affect the operation of the burners.

Oven

- The oven can be cleaned in conventional manner (with detergents, oven spray), but only when there is very dirty and when the stains are particularly stubborn.
- For regular cleaning of your gas oven (after each use), the following procedure is recommended: rotate the gas selection knob to the position aquaclean . Pour 0.5 liter of water into a baking tray and insert it into the lowermost guide. After twenty minutes, the food residues on the enamel will have softened, allowing you to wipe them with a damp cloth.

Cleaning the insert bottom panel

- Insert bottom panel must be completely cool.
- Slightly lift the insert bottom panel at the center of the front edge and pull it out of the oven.
- The insert bottom panel may be cleaned with non-aggressive detergents and grease removers; however, it must be thoroughly rinsed under running water to remove any detergent residues from the surface.
- Before replacing the insert bottom panel into the oven, it must be completely dry.
- Important: insert the bottom panel into the holes on the left and the right side at the front of the appliance; this will prevent it from moving during oven operation. Incorrectly inserted bottom panel may affect oven performance.

When dealing with stubborn stains, please not the following:

The oven should be cooled down before each cleaning process.

- Clean the oven and accessories after each use to prevent the dirt from being burnt onto the oven.
- The easiest way to remove grease is by using non-aggressive grease removers, when the oven has cooled down.
- In case of particularly stubborn dirt, use the conventional oven cleaners. Then, rinse the oven thoroughly with clean water to remove all residues of the cleaner.
- Never use aggressive cleaners such as steel wool, abrasive dishwashing sponges, stain removers, etc.
- When purchasing and dispensing detergents, consider the environment and observe the instructions provided by respective cleaning agent manufacturers.

Accessories

Wash the accessories (baking trays, grid, etc.) with hot water and some conventional detergent.

Easy-clean inserts (only with some models)

After each use, clean the easy-clean inserts in water with some detergent, using a soft brush, or wash them in a dishwasher.

Maintenance

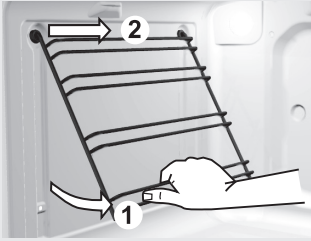

Removing wire guide racks (only with some models)

To facilitate cleaning of the oven interior side walls, the wire guide rack can be removed.

- Hold the guide rack by its lower end and rotate it inwards; then, remove them from the holes on the upper side.
- Clean the guide racks guides only with conventional cleaners.
- After cleaning, simply re-hang the guide rack by following the above instructions in the reverse order.

REMOVING INSIDE DOOR GLASS – APPLIES TO PREMIUM FULL-GLASS DOOR (make A and B)

Door glass can also be cleaned from the interior side; however, door has to be removed first (see section on removing and replacing the oven door).

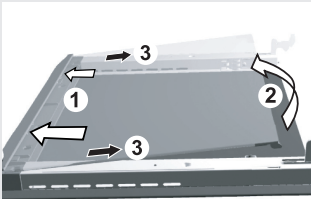

figure 1

a)

- Hold the door glass pane by its lower edge. Pull it gently towards yourself and lift it slightly – but not too far – by a maximum of 10 mm, until the glass support wedge slips out of the groove (Figure 1).
- Remove the glass (in the direction of arrow 3).

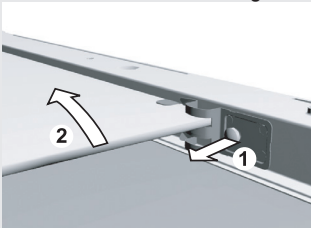

figure 2

- Interior glass (only in some models) is removed by first undoing the screws on the glass supports and then by lifting it (Figure 2). Remove the supports before cleaning the glass pane.

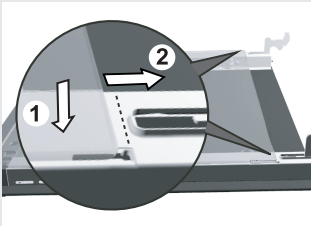

figure 3

- Reinstall the door by following the same procedure in reverse order.

Note: Insert the glass into the slot and push it forward (Figure 3).

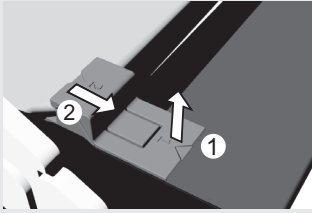

figure 1

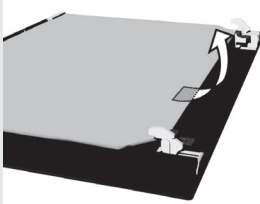

figure 2

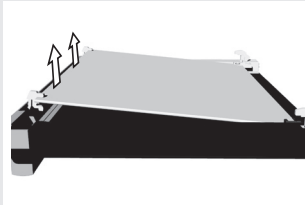

figure 3

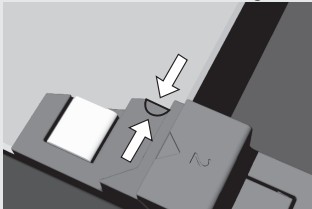

figure 4

b)

- Slightly lift the supports on the left and right side of the door (marking 1 on the support) and pull them away from the glass (marking 2 on the support) (see Figure 1).

- Hold the door glass by the lower edge, slightly lift it so that it is no longer attached to the support, and remove it (Figure 2).

- To remove the third inside glass (only with some models), lift and remove it. Also remove the rubbers on the glass (Figure 3).

- To replace the door, observe the reverse order.

Note: To replace the glass, make sure the markings (crescent) on the door and the glass are aligned (Figure 4).

REMOVING AND REPLACING THE OVEN DOOR WITH A CAM HINGE (only with some models)

- Completely open the oven door. Lift the clips of the lower hinge supports on both sides to the upright position and clip them to the plug of the upper hinge supports.
- Close the oven door half way and gently pull them out. Replace the door in the reverse order.
- Insert the door in the half-closed position (angle of approximately 60°) by pushing them towards the oven while opening them all the way. Pay attention to the notches on the lower hinge supports, which should coincide with the lower edge of the notches on the front side. When the door is completely opened, remove the clips from the plugs of the upper hinge supports and return them to horizontal position.

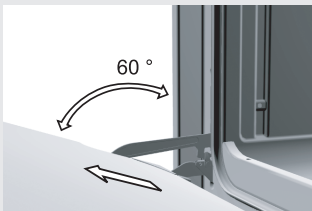
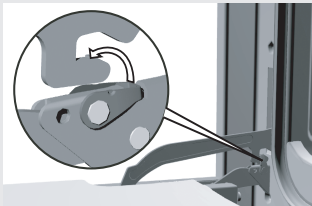

REMOVING AND REPLACING THE OVEN DOOR WITH A SINGLE-AXIS HINGE (depending on the model)

- a) Conventional closing
- b) Soft closing system (GentleClose) – the system absorbs the shock from door closing. It allows simple, quiet, and smooth closing. A gentle push (to a 15° angle relative to the closed door position) is enough for the door to close automatically and softly.

⚠ If the force applied to close the door is too strong, the effect of the GentleClose system is reduced or the system will be bypassed for safety.

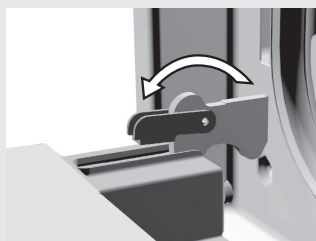

figure 1

- Fully open the oven door and rotate the stoppers all the way back – applies to conventional door closing (Figure 1).

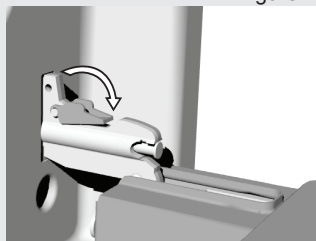

figure 2

- If the appliance is fitted with the GentleClose system, flip the door latches back to a 90° angle (Figure 2).

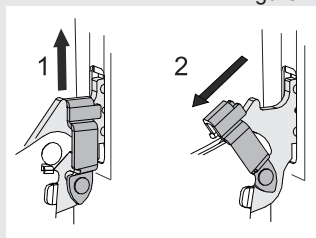
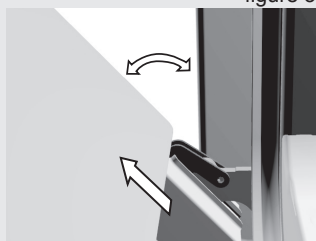

figure 3

- If the appliance is fitted with the GentleClose system, slightly lift the door latches and pull them towards you.



- Slowly close the door until the latches are aligned with the slots. Slightly lift the door and pull it out from both hinge slots on the appliance.
- Then, completely open the door and rotate the attachment clips back to their initial position. Slowly close the door and check, if they close properly. If the door does not open or close correctly, make sure whether the hinge notches are correctly placed in their seat hinges.

Cooker drawer

Replacing appliance parts

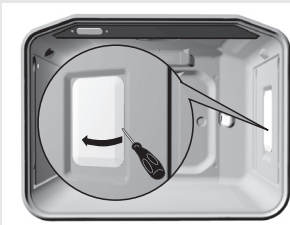
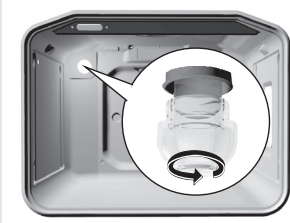

Attention

Always make sure the hinge attachment clips are firmly seated in their supports when installing the door. If this is not the case, the main hinge that is operated by a strong spring may be released any time while installing or removing the door. Risk of physical injury.

- Cooker drawer is protected against accidental opening. If you wish to open the drawer, raise it slightly. In order to remove the drawer, first pull it out to the stopper, then raise it again and pull it out completely.
- Do not store flammable, explosive, or temperature-sensitive objects and materials in the cooker drawer.
- With some appliances, the drawer is inserted by inserting the lower back slider into the guide on the cooker. If the cooker drawer is fitted with side guides with wheels, insert it by inserting the wheels into the guides and close the drawer.

The oven lamp base and socket are under voltage. There is a risk of electric shock!

Before replacing the oven lighting bulb, disconnect the cooker from the power mains by removing the fuses or tripping the main network switch.

Oven bulb

(only with some models)

Oven bulb is considered a replacement ware part and is not covered by the warranty. Replace the bulb with a new one with the following specifications: socket E 14, 230 V, 25 W, 300°C.

- Unscrew the glass cover in the counterclockwise direction, replace the bulb, and replace the cover.

Bulb lamps used in this appliance are special purpose lamps selected for household appliances use only. They are not suitable for household room illumination.

Special warnings and fault reports

During the warranty period, any repairs may only be performed by service technicians authorized by the appliance manufacturer.

Before starting the repair, the appliance must be disconnected from the power mains by removing the fuse or by removing the mains cord from the wall outlet.

Unauthorized tampering and repairs may cause the risk of electric shock and short circuit; therefore, do not attempt them yourselves. Leave such tasks to an expert or an authorized service technician.

In case of minor faults or problems with the appliance operation, check the following instructions to see whether you can eliminate the causes by yourselves.

Important

A visit by a service technician during the warranty period will be charged if the appliance is not functioning because of improper use. Store these instructions in a place where they are always readily accessible; if pass the appliance on to another person, the instructions should also be included.

Following is some advice on rectifying some common problems.

What happened...?	Possible cause	What to do?
The flame is uneven / unstable	Flame is uneven due to a wrong gas power setting.	Have an expert check the gas pipeline!
The flame from the burners suddenly changes	Wrongly assembled parts of the kitchen hob	Assemble the burner correctly.
Burner ignition takes a lot of time	Wrongly assembled parts of the kitchen hob	Assemble the burner correctly.
The flame is extinguished shortly after ignition	Knob pressed too short.	Keep the knob depressed for a longer period of time.
	Knob pressed too weakly.	Before releasing it, pres it harder.
The grid has discolored in the burner area?	This is a commonplace phenomenon resulting from high temperature	Clean the grid with a metal care detergent.
Electric power supply in general is interrupted?	The fuse may be blown.	Check the fuse in the fuse box and replace it if it is blown.
Electric ignition of the burners no longer works?	There are food or detergent residues between the spark plug and the burner.	Open and carefully clean the opening between the spark plug and the burner.
If the burner cover looks unappealing...	Regular dirt	Clean the burner covers with a metal care detergent.
Dew accumulates on the door glass while heating	Normal occurrence resulting from a difference in temperature	Not possible; does not affect the operation.
Smoke appears during cooking	Cooking temperature set too high	Set a lower cooking temperature
	Thermostat out of order	Have an expert replace the thermostat
The oven gets too dirty during operation	Cooking temperature set too high	Set a lower cooking temperature
	Grid and drip tray not inserted correctly	Set the grid above the drip tray and insert them into the same guide

What happened...?	Possible cause	What to do?
Fluid or soft batter distributed unevenly	Cooker not installed horizontally	Level the cooker (in models with adjustable feet adjust the feet height) to a fully horizontal position.
Cooking results are unsatisfactory	Wrong oven settings	Set the oven according to the instructions in the table
The pastry is too light-colored (bright) at the bottom	Wrong selection of guide (shelf) level	Move the baking tray to a lower height
	Baking tin was placed on a baking tray in the oven	Place the baking tin on the oven grid
Pastry is too dry	Temperature is too low	Increase the oven temperature
	Cooking time too long	Set a shorter cooking time
The pastry is sticky on the inside, meat is not thoroughly done	Cooking temperature too high	Decrease the temperature - cooking time can not be decreased by setting a higher temperature (done on the outside, raw on the inside)
	Cooking time too short	Select a longer cooking time, let the dough rise longer
	Too much liquid in the batter / dough	Add less liquid to the dough / batter

A list of authorized service centers and their respective phone numbers can be found in the warranty sheet attached.

Installation and connection

The appliance must be installed and connected in compliance with the relevant effective regulations. **Providing sufficient ventilation is particularly important.**

Important warnings

- The appliance may only be connected by a service technician authorized by the gas distribution company or an authorized service center.
- The room in which the appliance is installed must be regularly ventilated.
- Gas type that the appliance is adjusted to by the manufacturer is indicated on the rating plate.
- Before connecting the appliance, make sure that the local requirements for connection (gas type and pressure) are compatible with the appliance version / adjustment.
- This appliance is not connected to a combustion fumes exhaust system (i.e. a chimney). The appliance must be installed and connected in compliance with the relevant effective installation regulations. Special care must be taken to ensure adequate ventilation / aeration.
- The distance between the cooking hob and the kitchen hood should be no less than indicated in the instructions for kitchen hood installation.
- This appliance is appropriate for installation between two pieces of furniture (class 2/1); it can be in direct contact with them on both sides. On one side of the appliance, a piece of kitchen furniture that is higher than the appliance may be installed, if the distance between the appliance and this piece of furniture is not less than 10 centimeters. In such case, only a piece of furniture with a height not exceeding that of the cooker may be installed on the other side of the appliances. Hanging, or wall-mounted kitchen elements should be installed high enough not to interfere with the work process. The distance between the cooking hob and the kitchen hood should be no less than 650 mm.
- If the gas used in your pipeline is not compatible with the current appliance adjustment, call a service center or a gas distribution company. Their experts will adjust the appliance to be compatible with the gas type in your pipeline quickly and professionally.
- All other repairs and similar tasks that require the use of any tool whatsoever should only be carried out by an authorized service technician.
- The user may only perform those tasks that can be carried out without the use of tools.
- The walls and furniture closest to the appliance (floor, kitchen back wall, side walls) should be resistant to temperatures of at least 90°C.
- Mains cord on the back side of the appliance must be secured in such way that it is not in direct contact with the cooker back wall, as this wall heats up considerably during operation.

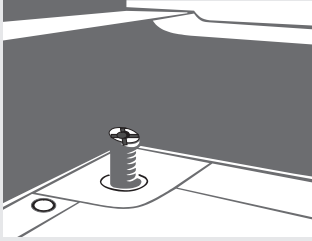

Leveling the cooker and additional support

The height of the cooker, including the support, is 90 cm; without the support, it is 85 cm. The support features two casters at the left and right side at the back; these facilitate moving the cooker. At the front, left and right, the support is fitted with adjustment screws that can be used to level the cooker horizontally and to level its upper edge flush with the furniture element standing next to it (if any).

The adjustable feet are accessible, when the cooker drawer is removed; if required, they may be turned to increase or decrease the height, until the appliance is not in a completely horizontal position. The adjustment screws can easily be turned if the cooker is tilted slightly to redistribute the load. Additional support may also be removed by undoing the four screws from the lower side; these screws attach the support to the cooker side walls. In this case, remove the adjustment screws from the support and insert them left and right into the lower front cooker support panel. Level the cooker horizontally as described above. Some cookers are fitted with four adjustment screws at the lower part (two at the front and two at the back); these are intended for leveling uneven floor or for adjusting the cooker height to the level of the kitchen furniture elements installed next to the cooker.

Protecting the appliance from tipping over

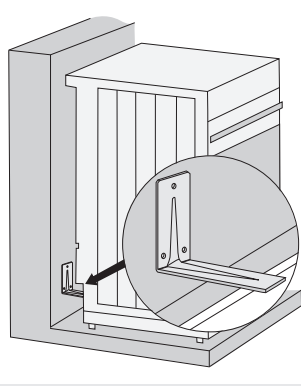

Figure 1

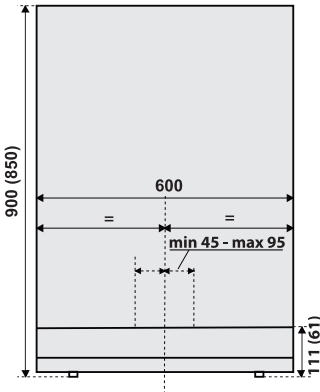

Figure 2

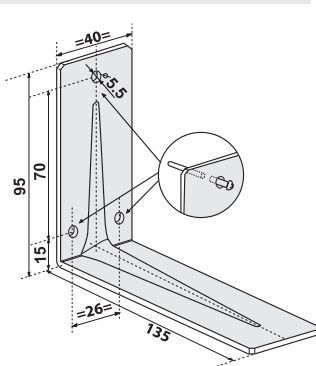

Figure 3

The appliance can be protected against tipping over using the supplied angle bracket.

Before installing, we recommend placing the appliance and levelling it according to your requirements using the adjustable feet (see chapter Levelling the Appliance and additional support).

Please refer to Figure 2, illustrating the appliance's built-in dimensions, with angle bracket installed and adjustable feet fully retracted.

Make sure the angle bracket is placed within the specified zone.

- Select the starting position for installation and push the appliance all the way to the wall.
- Pull out the appliance drawer.
- Use a pencil to mark the middle of the appliance on the wall, through the opening in the lower part of the appliance. Then, make another mark 45 to 95 millimetres to the right of the middle (Figure 2).
- Place the shorter end of the angle bracket against the mark on the wall. The longer end of the bracket should touch the upper surface of the profile at the back of the appliance (Figure 1).
- Through the holes in the lower part of the appliance, mark the centres of the three holes with diameter of 5.5 millimetres. These holes are located on the shorter end of the angle bracket pressed against the wall (Figure 3).
- Pull the appliance out of the starting position. Drill three holes at the marked spots and insert the supplied plastic wall plugs.
- Attach the bracket to the wall with the screws supplied.
- Push the appliance to the selected starting position and replace the drawer.

NOTES:

- The measures in parenthesis are the built-in dimensions of the angle bracket without the additional support.
- If the screws and wall plugs supplied do not allow attaching the supplied bracket firmly to your wall to prevent the appliance from tipping over, use other fittings to attach the angle bracket in a way that will prevent it from being pulled out of the wall.

Connection to the gas supply

Factory settings

- Gas appliances are tested and fitted with the CE symbol.
- Gas appliances are delivered sealed; upon delivery, they are adjusted to the natural gas type H or E (20 mbar), or to liquid gas (50 or 30 mbar). The data is indicated on the rating plate located on the inner side of the oven; it is visible when oven door is opened.
- Load and gas consumption for particular burners are indicated in the table in these instructions.
- When the appliance is readjusted to another type of gas, the nozzles must also be replaced (see the section “Nozzle table”).
- In case of repair, or if the seal is damaged, all functional parts must be tested and resealed in compliance with the installation instructions. Functional parts include the following: fixed nozzle for large flame and adjustable regulation valve / screw for small flame.

Connection to the gas supply

- When connecting the appliance to the gas pipeline or gas cylinder, follow the regulations of the local gas distributor.
- On the right side, the cooking hob is fitted with a gas connection plug with an EN ISO 10226-1 / -2 or EN ISO 228-1 (Depending on the country-specific connection regulations.) external thread.
- Also supplied with the appliance is an adapter for liquid gas and a non-metal gasket.
- When connecting, the knee R ½ should be held firmly to prevent it from rotating.
- For sealing of the connection joints, use a non-metal approved gaskets and approved sealants.
- The gaskets should only be used once. The thickness of the flat non-metal gaskets should not be deformed more than by 25 percent.
- To connect the appliance to the gas supply, use a tested and certified flexible hose. The hose should not be in direct contact with the appliance back wall or the oven ceiling.



After connecting the gas hob, check the joints for any leakages.

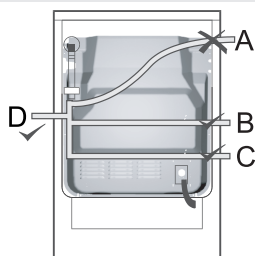

Connection with a flexible hose

- If an appliance is connected with a flexible hose, the hose should not be fed as indicated in the Figure A.
- If the connection pipe is made of metal, the option A is also permissible.

Start of operation

When putting the appliance into operation, follow the instructions for use. Turn on all heaters and check the stability of the flame at high and low setting. The flame should be blue and green at the center.

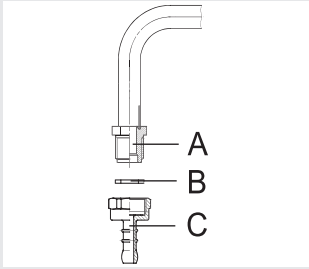

Connection to the gas supply plug

- A** EN ISO 10226-1 / -2 or EN ISO 228-1 (Depending on the country-specific connection regulations.) connection plug
- B** Non-metal gasket with thickness of 2 mm
- C** Pipe adapter for liquid gas (Depending on the country-specific connection regulations.)

After the connection, check the burners for correct operation. The flames must be clearly visible, and should be blue and green at the center. If the flame is unstable, increase the minimum power. Explain the use of the burners to the user and read the instructions for use together.

Adaptation to a different type of gas

- The procedure or adaptation of the cooker to another type of gas does not require removal of the appliance from the worktop.
- Before adapting, disconnect the appliance from the power mains and close the gas supply valve.
- Replace the existing nozzles for nominal thermal load with corresponding nozzles for the new gas type (see table below).
- When adapting the appliance to liquid gas, fasten the regulation screw for minimum thermal load as far as it will go, in order to attain minimum thermal load.
- When adapting the appliance to natural gas, release the minimum thermal load regulation screw in order to attain minimum thermal load, but do not rotate it by more than 1.5 turns.

After the appliance has been adapted to another type of gas, stick a new label with the new data on the appliance gas type adjustment (on the rating plate) over the old one, and check the appliance functionality and sealing. Make sure the electric conductors, capillary thermostats, and thermo-elements do not reach into the gas flow area.

Adjustment elements

- Adjustment elements for minimum load of the burners are accessible through the openings in the control panel.
- Remove the support grid and burner covers with the crown.
- Remove the control knobs.

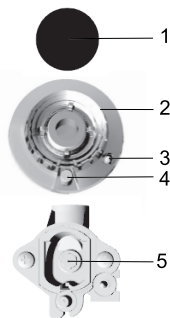

Cooker burner (Figure 1)

- 1 Burner crown cover
- 2 Burner crown with cover support
- 3 Thermo-element (only in protected burners, only available in some models)
- 4 Spark plug
- 5 Nozzle

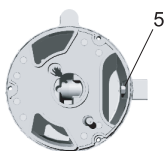

Triple burner (Figure 2)

- 5 Nozzle

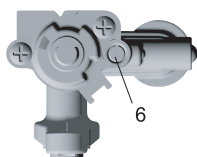

Gas valve fitted with a protection device (Figure 3)

- 6 Minimum thermal load regulation screw



Gas valve without a protection device (Figure 4)

- 6 Minimum thermal load regulation screw

Cooker burner	Figure / drawing number	Element code
Nominal thermal load	1,2	5
Minimal thermal load	3,4	6

Oven burner adjustment elements (Figure 5)

To access the elements for adjusting the oven burner to another type of gas, the control panel has to be removed, as well as bottom panel of the oven, and the oven burner (undo the screws at the front of the burner and pull it slightly forward). To access the oven nozzle, remove the shutter.

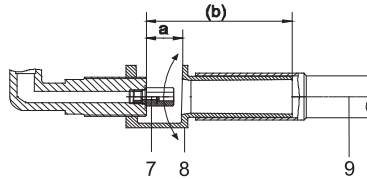

- 7 Nozzle
- 8 Shutter
- 9 Oven burner

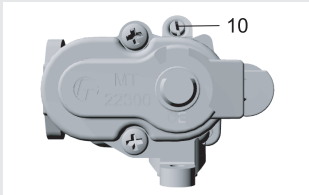

The gas valve fitted with a thermostat (Figure 6)

10 Minimum thermal load regulation screw

Infra heater regulation elements (Figure 7)

To access the elements for adjusting the infra burner / heater to another type of gas, remove the infra burner (undo the screw at the front of the burner and pull it slightly forward). To access the oven nozzle, remove the shutter.

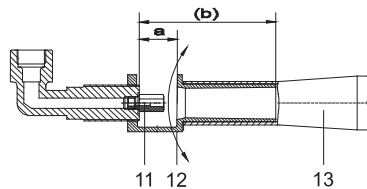

- 11 Nozzle
- 12 Shutter
- 13 Burner

Elements to be replaced or adjusted when adapting the oven to another type of gas

Oven burner, infra burner		Figure number	Element code
	Nominal thermal load	5	7,8
Oven burner	Minimal thermal load	6	10
Infra burner	Nominal thermal load	7	11,12

Settings for the primary air regulation shutter are described in the table below:

	G20/20mbar G25/25mbar G20/25mbar	G20/13mbar	G30/30mbar	G30/50mbar	G30/37mbar G27/20mbar	G2.350/13mbar G27/20mbar-	G25/20mbar G25.1/25mbar	G110/8mbar G120/8mbar
Oven burner* (Figure 5)	a=5mm (b=50mm)	a=2,5mm (b=47,5mm)	a=7mm (b=52mm)	a=3mm (b=48mm)	a=7mm (b=52mm)	a=2mm (b=47,5mm)	a=1,5mm (b=46,5mm)	a=5mm (b=50mm)
Infra burner (Figure 7)	a=4mm (b=49mm)	a=7mm (b=52mm)	a=7mm (b=52mm)	a=3mm (b=48mm)	a=7mm (b=52mm)	a=2mm (b=47mm)	a=2mm (b=47,5mm)	a=4mm (b=49mm)
More primary air - rotate the shutter to the left; less primary air - rotate the shutter to the right.								

*) Primary air is set correctly when the flame is stable and when the blue-green core of the flame is clearly visible (somewhat less with liquid gas). The distances "a" and "b" are given as orientation values.

Connection to the power mains

The appliance may only be connected to the power mains by an authorized service technician or a registered electrician! Incorrect connection may result in damage to or destruction of respective parts of the appliance; in such cases, the warranty is void.

" The appliances are suitable for photovoltaic electrical power under the condition that electrical voltage will be 220VAC - 240VAC with semi tonic frequency 50Hz in order the appliance to operate properly (alternative a generator can be used with the same technical characteristic)."

- Open the connection clip using a screwdriver, as indicated on the figure on the cover.
- The voltage (230V against N) in your home network must be checked by an expert using appropriate equipment!
- The connection bridges must be placed in compliance with the network connection!
- Before connection, make sure the voltage on the rating plate is consistent with the actual network voltage.
- The length of the power cord should be at least 1.5 meters; thus, the appliance can be connected before it is pushed to the wall.
- The length of the power cord should be adjusted in such way that in case of pulling load on the cable, the ground wire is strained later than the voltage wires.

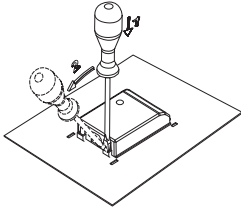

230V~

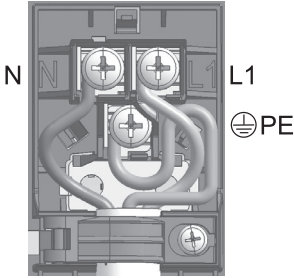

Procedure

- Use a screwdriver to open the cover of the connection terminal on the back of the appliance. Release the two clips as indicated on the cover of the connection terminal.
- The mains cord must be inserted into the strain release device which protects the cable from being pulled out. If the strain release device is not installed yet, install it in such way that it gets stuck in the connection terminal housing at one end.
- Then, connect the appliance according to the instructions indicated on the figures. If network voltage is different, the connection bridges should be replaced.
- Firmly fasten the strain release device and close the cover.

Lead colors

L1, L2, L3 = external leads under voltage. Normally, the lead colors are black, black, brown.

N = neutral lead, normally blue.

Make sure the N-lead is connected correctly!

PE = protection, or earth (ground) lead, normally green-yellow.

Nozzle table

gas type, pressure		Auxiliary burner				Normal burner		large burner	
Wobe Number		Standard		Quick					
		max	min	max	min	max	min	max	min
Natural gas H Wo=45,7+ 54,7 MJ/m3 Natural gas E Natural gas E+ Wo=40,9+54,7 MJ/m3 G20, p=20mbar	Nom. therm. load (kW)	1	0,36	1	0,36	1,90	0,46	3	0,76
	Consumption (l/h)	95,21	34,4	95,21	34,4	180,9	43,8	285,64	72,4
	Nozzle type (1/100mm)	77	-	78	-	104	-	129	-
	Nozzle code	162081		162082		162083		162084	
Liquid gas 3+, B/P Wo=72,9+87,3MJ/m3 G30 p=30 mbar	Nom. therm. load (kW)	1	0,36	1	0,36	1,90	0,46	3	0,76
	Consumption (g/h)	71,7	26,2	71,7	26,2	138,1	33,4	215,0	55,3
	Nozzle type (1/100mm)	50	29/24	50	29/24	69	33/26	87	43/33
	Nozzle code	162162		162162		162164		162165	
Natural gas H Wo=45,7+ 54,7 MJ/m3 G20 p=13mbar	Nom. therm. load (kW)	1	0,36	1	0,36	1,90	0,46	3	0,76
	Consumption (l/h)	95,21	34,4	95,21	34,4	180,9	43,8	285,64	72,4
	Nozzle type (1/100mm)	87		85		115		145	-
	Nozzle code	162165		w=+0,5		162171		162172	

gas type, pressure		Triple burner		Oven burner		Infra burner
Wobe Number		max	min	max	min	
		Natural gas H Wo=45,7+ 54,7 MJ/m3 Natural gas E Natural gas E+ Wo=40,9+54,7 MJ/m3 G20, p=20mbar	Nom. therm. load (kW)	3,5	1,56	3,5
Consumption (l/h)	333,2		148,5	339	77,1	259
Nozzle type (1/100mm)	140		•	135	•	120
Nozzle code	162085			609288		609287
Liquid gas 3+, B/P Wo=72,9+87,3MJ/m3 G30 p=30 mbar	Nom. therm. load (kW)	3,5	1,56	3,5	0,81	2,7
	Consumption (g/h)	254,5	113,4	250,9	58,9	193,5
	Nozzle type (1/100mm)	93	57/57	90	42/42	81
	Nozzle code	162166		609290		609289
Natural gas H Wo=45,7+ 54,7 MJ/m3 G20 p=13mbar	Nom. therm. load (kW)	3,5	1,56	3,5	0,81	2,7
	Consumption (l/h)	333,2	148,5	339	77,1	259
	Nozzle type (1/100mm)	157	•	156	*	134
	Nozzle code	162173		621111		621112

- Regulation valves that are factory-built-in are intended for liquid gas; however, the valves are set for operation with the type of gas for which the appliance is factory-preset.
- When adapting the appliance for use with another type of gas, the regulation screw (valve) should be fastened or release to correspond with the required gas flow / throughput (however, the regulation screw should not be released more than by 1.5 rounds from the position in which it is completely fastened).

Burner power is indicated by observing the upper Hs caloric value.

Warning: these tasks may only be carried out by a qualified technician, authorized by the gas distributing company or authorized service center!

Technical characteristics

Rating plate

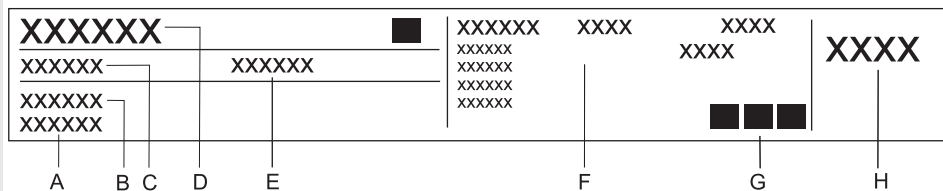

- A** Serial number
- B** Model
- C** Type
- D** Trademark
- E** Code
- F** Technical information
- G** Compliance indications / symbols
- H** Factory settings for gas type

WE RESERVE THE RIGHT TO MAKE ANY CHANGES
THAT DO NOT AFFECT THE FUNCTIONALITY OF THE
APPLIANCE.

Instructions for use of the appliance can also be found on our
website at www.gorenje.com / < <http://www.gorenje.com> / >

