

**Hisense**

# QUICK SETUP GUIDE

Before using the TV, please read this guide thoroughly and retain it for future reference.

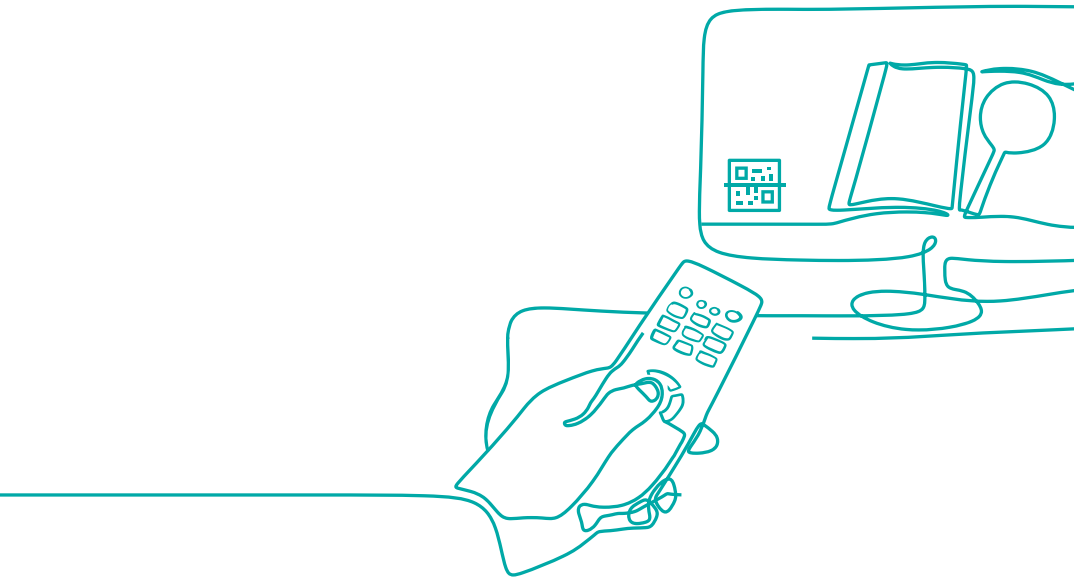

ES-A220707-1

**English**

# Find what you want

This TV is equipped with a quick setup guide and embedded E-Manual. Before using the TV, please read the following documentation.

## Quick Setup Guide

Please read the quick setup guide to learn about the following content:

Accessories  
Installation  
Specifications



## E-Manual

To get more information, please check the E-Manual.

Find the E-Manual in **Settings > Support > E-Manual**.



## E-Manual support functions



**Search**

Find the help you are looking for.

---



**Try Now**

Go directly to the function page and try it.

---



**QR Code**

Scan to open the E-Manual on your mobile device.

## Declaration

---

Any content and service accessed through this device, while only intended for individual non-commercial use, shall be the property of the applicable third party and subject to protection by regulations and laws on copyright, patent, trademark and other intellectual property rights. No part of such content and service may be modified, duplicated, published, uploaded, distributed, translated, marketed, or used to make and distribute products derived from it without the prior permission of the content owner or service provider.

You acknowledge and agree explicitly that you will solely bear the risk associated with the use of this device, and further you will solely bear any risk related to satisfactory quality, performance and accuracy for any content and service accessed through this device. To the maximum extent permitted by applicable law, this device and any third party's content and service is provided as it is without any guarantee, express or implied.

Manufacturer hereby declare explicitly that Manufacturer shall not be held liable for any guarantee and conditions, express or implied, related to this device and any content and service, including but not limited to warranty on marketability, satisfactory quality, fitness for a particular purpose, accuracy, quiet use and non-violation of any third party's rights; to the maximum extent permitted by applicable law, Manufacturer gives no guarantee on the accuracy, validity, timeliness, legitimacy and completeness of any content or service provided through this device, or the fitness of such device, content or service for your particular requirement, or the protection from interruption and error during operation of such device, content or service; to the maximum extent permitted by applicable law, in any case, including fault or neglect, Manufacturer shall not be held liable for legal actions or indemnity obligation arising from any consequence as a result of or related to any information loaded in this device or use of such device, content or service by you or any third party.

Any content and service provided as it is together with this device shall be the property of the applicable third party, therefore Manufacturer gives no declaration or warranty on modification, suspension, cancellation, termination or abortion thereof, and shall not be held liable for legal actions or indemnity obligation arising thereof.

Manufacturer reserves the rights to restrict the use or access of certain content or service. As the content and service are transmitted through third party's network and transmission facilities, Manufacturer undertakes no customer service thereof or the obligation for such customer service.

## Important Safety Precautions



This symbol alerts user about the presence of a dangerous voltage not isolated inside the product which can be sufficiently powerful to constitute a risk of electrocution.



This symbol alerts user about the presence of important operating instructions and maintenance in the document enclosed in the package.



**ATTENTION**

**RISK OF SHOCK  
ELECTRIC**



Do not open the back cover.

In no case the user is allowed to operate inside the TV set. Only a qualified technician is entitled to operate.



Class II product : This symbol indicates that it does not require a safety connection of protective earthing (ground). (For 55")



Class I product: This symbol indicates that it requires a safety connection of protective earthing (ground). (For 65")



AC voltage: This symbol indicates that the rated voltage marked with the symbol is AC voltage.

## Disposal of Used Electrical & Electronic Equipment



Packaging and electrical goods should be recycled appropriately, and not treated as household waste. Please dispose of this equipment at your applicable collection point for the recycling of electrical & electronic equipment waste. By ensuring the correct disposal of this product, you will help prevent potentially hazardous to the environment and to human health, which could otherwise be caused by unsuitable waste handling of this product. The recycling of materials will help conserve natural resources. Please do not therefore dispose of your old electrical and electronic equipment with your household waste. For more detailed information about recycling of this product, please contact your local city office, your household waste disposal service or the shop where you purchased the product.



## Important Safety Precautions

### Warning

---

---

A television set may fall, causing serious personal injury or death. Many injuries, particularly to children, can be avoided by taking simple precautions such as:

- ALWAYS use cabinets or stands or mounting methods recommended by the manufacturer of the television set.
- ALWAYS use furniture that can safely support the television set.
- ALWAYS ensure the television set is not overhanging the edge of the supporting furniture.
- ALWAYS educate children about the dangers of climbing on furniture to reach the television set or its controls.
- ALWAYS route cords and cables connected to your television so they cannot be tripped over, pulled or grabbed.
- NEVER place a television set in an unstable location.
- NEVER place the television set on tall furniture (for example, cupboards or bookcases) without anchoring both the furniture and television set to a suitable support.
- NEVER place the television set on cloth or other materials that may be located between the television set and supporting furniture.
- NEVER place items that might tempt children to climb, such as toys and remote controls, on the top of the television or furniture on which the television is placed.

If your existing television set is being retained or relocated, the same considerations as above should be applied.

# Important Safety Precautions

## Safeguards

---

Please read the following safeguards for your TV and retain for future reference. Always follow all warnings and instructions marked on the television.

### 1. A note about safety and operating instructions

Read and follow all safety and operating instructions, and retain them safely for future reference.

### 2. Heed Warnings

Adhere to all warnings on the appliance and in the operating instructions.

### 3. Cleaning

Unplug the TV from the wall outlet before cleaning. Do not use liquid, abrasive, or aerosol cleaners. Cleaners can permanently damage the cabinet and screen. Use a lightly dampened cloth for cleaning.

### 4. Wall Mount Bracket

Wall mount bracket is only available for some models. If wall mount bracket is not supplied with this product, you can buy it at the local market.

Please refer to the installing the wall mount bracket page of Quick Setup Guide for dimensions.

### 5. Water and Moisture

Avoid dripping or splashing of liquids onto the product. Objects filled with liquids, such as vases, should not be placed on the product.

### 6. Setting

Do not place this TV on an unstable cart, stand or table. Placing the TV on an unstable base can cause the TV to fall, resulting in serious personal injuries as well as damage to the TV. Use only a cart, stand, bracket or table recommended by the manufacturer or salesperson.

### 7. Ventilation

Slots and openings in the cabinet are provided for ventilation, to ensure reliable operation of the TV and to protect it from overheating. Do not cover the ventilation openings in the cabinet and never place the set in a confined space such as built-in cabinet unless proper ventilation is provided. Leave a minimum 10cm gap all around the unit, the rear of the TV should be 6cm away from the wall.

### 8. Power Source

This TV should be operated only from the type of power source indicated on the marking label. If you are not sure of the type of power supplied to your home, consult your appliance dealer or local power company.

## Important Safety Precautions

### 9. Power-Cord Protection

Power- supply cords should be routed so that they are not likely to be walked on or pinched by items placed upon or against them, paying particular attention to cords at plug, wall outlets, and the point where they exit from the TV. MAIN plug on the power cord is used as the disconnect device, the disconnect device and socket-outlet shall be easily accessible.

### 10. Lightning

For added protection for this TV during a lightning storm, or when it is left unattended and unused for long periods of time, unplug it from the wall outlet and disconnect the antenna or cable system. This will prevent damage to the TV due to lightning or power-line surge.

### 11. Power Lines

An outside antenna system should not be located in the vicinity of overhead power lines or other electric light or power circuits, or where it can fall into such power lines or circuits. While installing an outside antenna system, extreme care should be taken to keep from touching such power lines or circuits as contact with them might be fatal.

### 12. Overloading

Do not overload wall outlets and extension cords as this can result in a risk of fire or electric shock.

### 13. Object and Liquid Entry

Never push objects of any kind into this TV through openings as they may touch dangerous voltage points or short-out parts that could result in fire or electric shock. Never spill liquid of any kind on or into the TV.

### 14. Outdoor Antenna Grounding

If an outside antenna or cable system is connected to the TV, be sure the antenna or cable system is grounded so as to provide some protection against voltage surges and built-up static charges.

### 15. Servicing

Do not attempt to service this TV yourself as opening or removing covers may expose you to dangerous voltage or other hazards. Refer all servicing to qualified service personnel.

### 16. Damage Requiring Service

Unplug the TV from the wall outlet and refer servicing to qualified service personnel under the following conditions:

- (a) When the power - supply cord or plug is damaged.
- (b) If liquid has been spilled, or objects have fallen into the TV.
- (c) If the TV has been exposed to rain or water.

## Important Safety Precautions

- (d) If the TV does not operate normally by following the operating instructions. Adjust only those controls that are covered by the operating instructions as an improper adjustment of other controls may result in damage and will often require extensive work by a qualified technician to restore the TV to its normal operation.
- (e) If the TV has been dropped or the cabinet has been damaged.
- (f) When the TV exhibits a distinct change in performance - this indicates a need for service.

### 17. Replacement Parts

When replacement parts are required, be sure the service technician has used replacement parts specified by the manufacturer or have the same characteristics as the original part. Unauthorised substitutions may result in fire, electric shock or other hazards.

### 18. Safety Check

Upon completion of any service or repair to the TV, ask the service technician to perform safety checks to determine that the TV is in safe operating condition.

### 19. Heat

The product should be situated away from heat sources such as radiators, heat registers, stoves, or other products (including amplifiers) that produce heat.

### 20. Fire

The product should be situated away from naked flame sources such as lighted candle.

### 21. Off-gassing

The TV smells of plastic is normal and will dissipate over time.



Do not mix and use new batteries with old batteries, or batteries with different types. Do not expose batteries to heat such as direct sunlight or fire. Make sure the batteries' positive and negative ends are facing the correct direction.



The device should not be exposed to dripping and spraying and it cannot be placed under objects filled with liquids.



To fully disconnect the TV, remove power plug from wall socket. Be sure to have the wall socket and power plug readily accessible.



Apparatus with CLASS I construction shall be connected to a MAINS socket outlet with a protective earthing connection. (For 65")

# Contents

Figures and illustrations in this manual are provided for reference only and may differ from actual product appearance.

Parts of the software function changes with the system upgrade.

## Contents

Accessories List.....	1
Installing the Stand or Wall mount bracket.....	2
TV Front.....	5
TV Rear .....	6
Making Connections .....	7
Remote Control .....	10
Turning the TV on for the First Time.....	17
Specifications .....	18
Other Information.....	19

## Accessories List

The following accessories are included with TV:

Quick Setup Guide × 1	Screw × 12	Base Stand × 1(including 2 parts)
AA or AAA Battery × 2	Remote Control × 1	Power Cord × 1

### NOTE

- The accessories may be different from the list above due to different models, countries / regions. Please refer to the actual accessory bag.

# Installing the Stand or Wall mount bracket

## ⚠ CAUTION

- Be sure to disconnect the AC power cord before installing a stand or wall mount brackets.
- The display on your TV is fragile. Make sure the TV screen is not scratched or damaged by hard objects or from pressure.
- After the installation is completed, make sure the TV is steady on a table or firmly attached to a wall mount, before removing all protective film, if any.

## ► Installing the stand

Follow the illustrations and instructions below to complete the installation steps:

1. Carefully place your TV face-down on a soft, flat surface to prevent damage to the TV or scratching to the screen.

2. Take out the Base Stand Part A and open it from top, then separate it into Part a1 and Part a2.

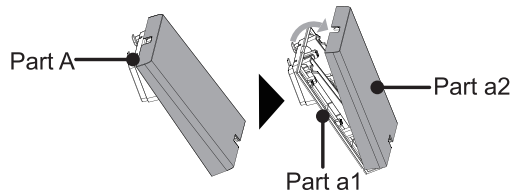

3. Put Part a1 onto the back cover of the TV.

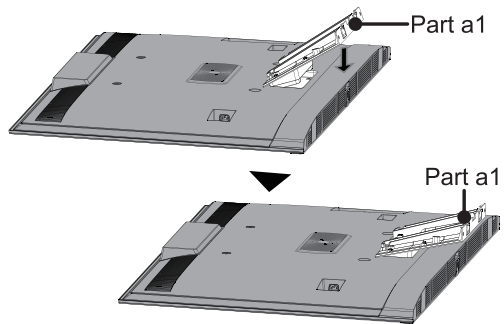

4. Secure Part a1 with 4 screws (M5×12) onto the back cover of the TV.

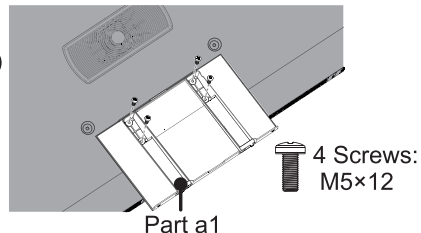

## Installing the Stand or Wall mount bracket

5. Hook Part B to Part a1 as the illustration shows. Please note that the side with 4 pads should be placed outward.

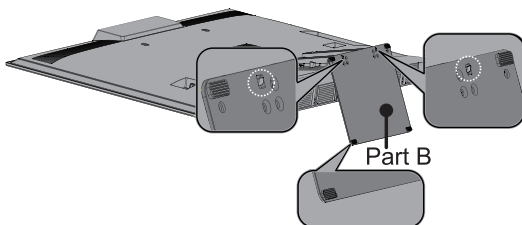

6. Then, secure Part B with 6 screws (M5×16).

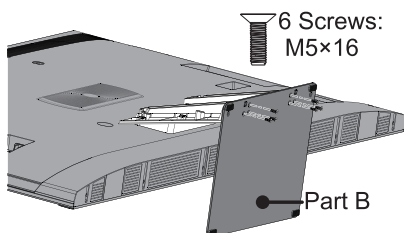

7. Next, secure Part B with 2 screws (ST4×12).

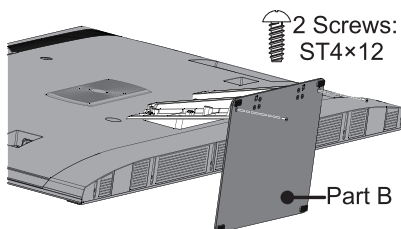

8. You can tidy the cables into slots of Part a1.

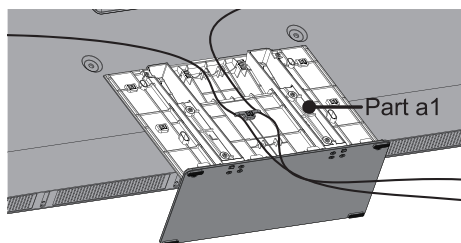

9. Place Part a2 onto Part a1.

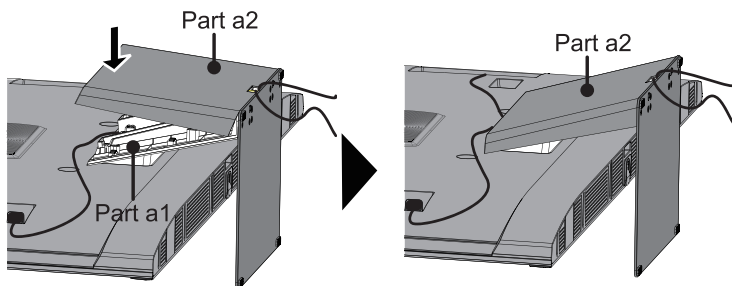

## Installing the Stand or Wall mount bracket

10. Slightly push the centre of the Part a2, then slightly pinch the both sides.

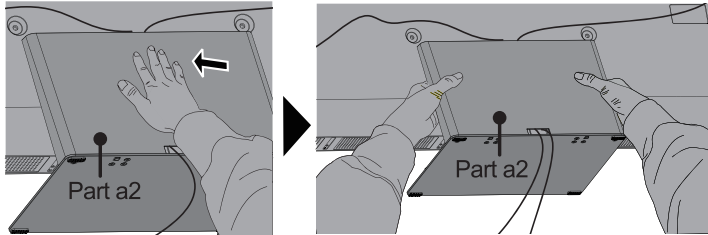

11. Now, you can place the TV on a surface, and tear off all protective film on TV.

### ► Installing the wall mount bracket

Before mounting the TV, remove the TV stand if you have already attached it, and make sure the wall mount bracket supports the weight of your TV.

#### ⚠ CAUTION

When mounting the TV on a wall, follow instructions provided with the wall mount bracket. If it is not correctly mounted, the TV may fall and cause property damage or personal injury.

- Place spacers between the TV and bracket.
- Standard dimensions are shown below.

Wall mount hole pattern (mm)	400 × 300 (55") 400 × 400 (65")
Wall mount screw size	M6

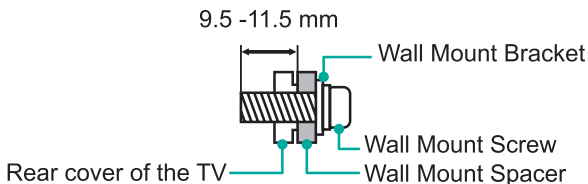

- We do not recommend hanging the TV on a slanted wall, and when wall mounting make sure your television remains parallel to the wall and does not lean forward.

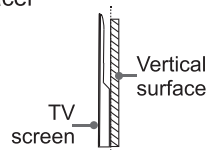

#### 📌 NOTES

- The diameter and length of the screws differ depending on the wall mount bracket model.
- Wall mount bracket is optional. Your TV may not have wall mount bracket. Please refer to the actual accessories.



## TV Front

### TV Front

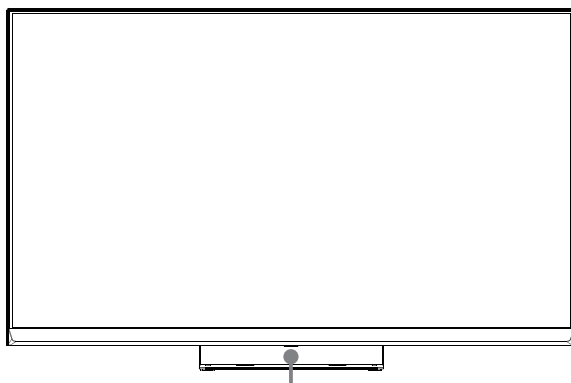

Remote sensor/Light sensor/Power indicator/Single button (Standby/Source)

<i>Item</i>	<i>Description</i>
<b>Remote sensor</b>	Receive remote signals from the remote control. Do not put anything near the sensor, as its function may be affected.
<b>Power indicator</b>	The light is white in standby mode.
 <b>Standby / Source</b>	Press the single button when in standby mode, and the TV will be turned on. Press the single button to call up the menu. When the focus is on "Power Off", wait for 3 seconds, and then the TV will go into standby mode automatically. Press the single button to call up the menu, and then select among the different input signal sources.

#### NOTES

- The Picture is Only for Reference.
- Powering on the TV requires several seconds to load programmes. Do not rapidly turn the TV off as it may cause the TV work abnormally.

## TV Rear

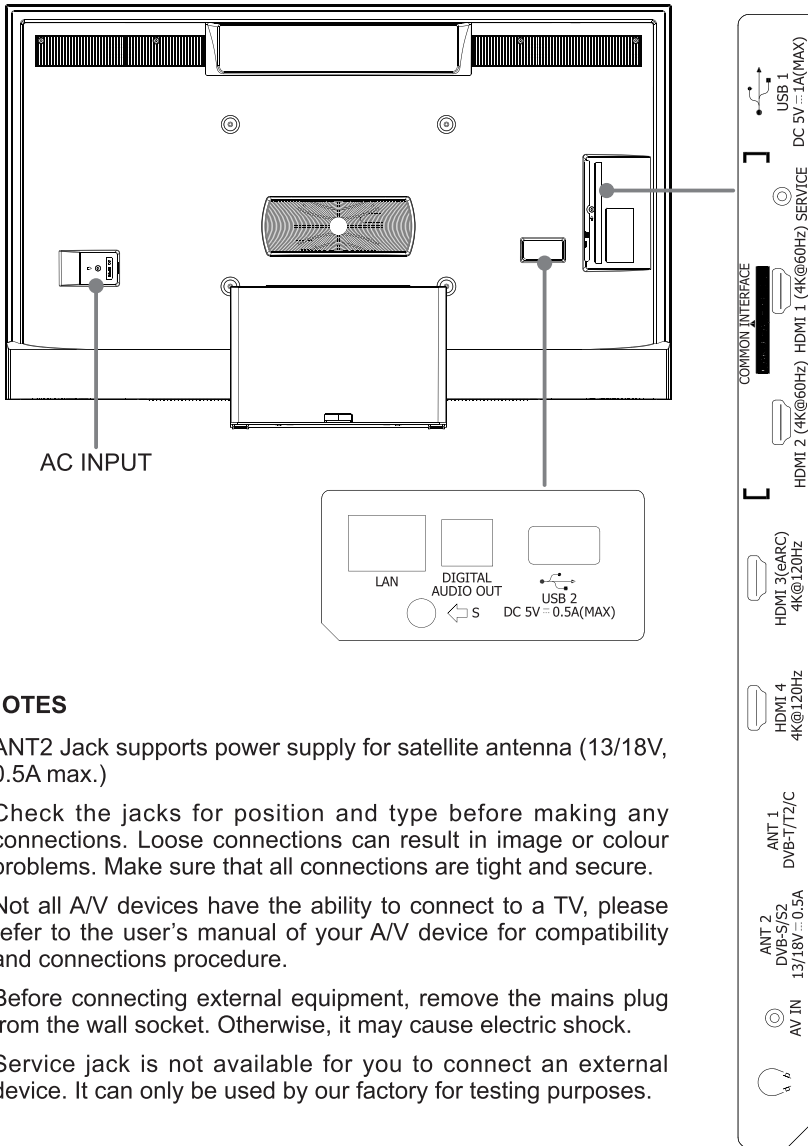

### NOTES

- ANT2 Jack supports power supply for satellite antenna (13/18V, 0.5A max.)
- Check the jacks for position and type before making any connections. Loose connections can result in image or colour problems. Make sure that all connections are tight and secure.
- Not all A/V devices have the ability to connect to a TV, please refer to the user's manual of your A/V device for compatibility and connections procedure.
- Before connecting external equipment, remove the mains plug from the wall socket. Otherwise, it may cause electric shock.
- Service jack is not available for you to connect an external device. It can only be used by our factory for testing purposes.

# Making Connections

## ► LAN (Wired setup)

Connect your TV to your network by connecting the LAN port on the back of your TV to an external modem or router using a LAN (Ethernet/Cat 5) cable. See the illustration below.

- It is recommended to use a modem or router that supports Dynamic Host Configuration Protocol (DHCP). Modems and routers that support DHCP automatically provide the IP address, subnet mask, gateway, and DNS, so you don't have to enter them manually. Most home networks already have DHCP.

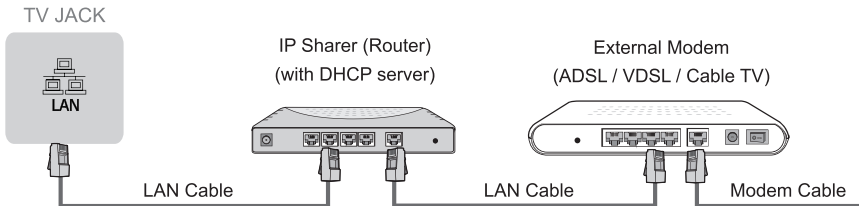

## Wireless setup

To connect your TV to your network wirelessly, you need a wireless router or modem. See the illustration below.

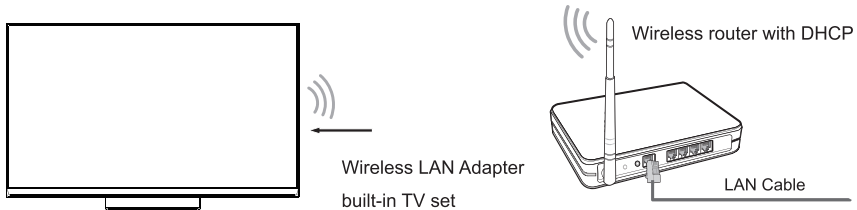

- The built-in Wireless LAN Adapter supports the IEEE 802.11 a/b/g/n/ac/ax communication protocols. It is recommended to use IEEE 802.11ax router. Low transfer rates for b/g may have the influence on the quality of streamed videos and other media.



## ☒ NOTES

- You must use the built-in Wireless LAN Adapter to use a wireless network because the set doesn't support external USB network adapters.
- If the wireless router supports DHCP, your TV can connect more easily to the wireless network.
- If you apply a security system other than the systems listed below, it will not work with the TV.  
Security system: WPA, WEP, WPA2.
- In order to guarantee smooth network, the distance between router and TV should be less than 10 metres.

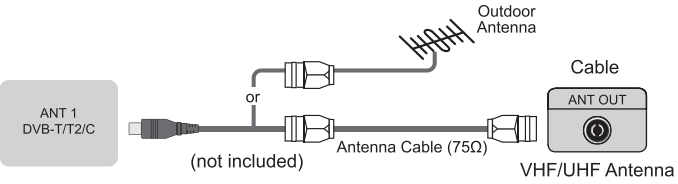
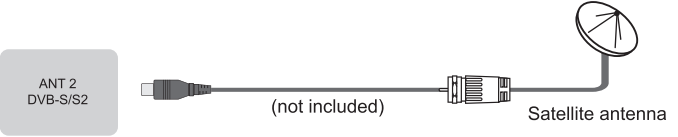
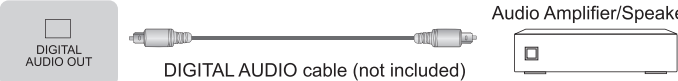
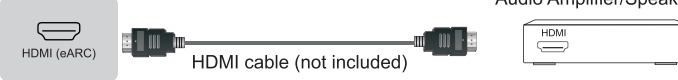
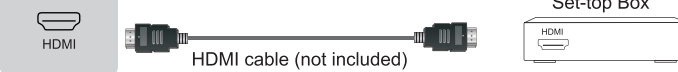
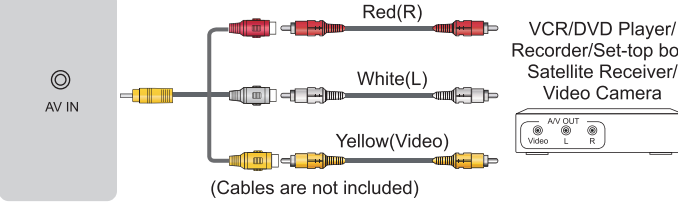
# Making Connections

<p><b>ANT</b></p>		 <p>ANT 1 DVB-T/T2/C</p> <p>Outdoor Antenna</p> <p>or</p> <p>Antenna Cable (75Ω)</p> <p>Cable</p> <p>ANT OUT</p> <p>VHF/UHF Antenna</p> <p>(not included)</p>
		 <p>ANT 2 DVB-S/S2</p> <p>(not included)</p> <p>Satellite antenna</p>
<p><b>DIGITAL AUDIO OUT</b></p>		 <p>DIGITAL AUDIO OUT</p> <p>DIGITAL AUDIO cable (not included)</p> <p>Audio Amplifier/Speaker</p>
<p><b>HDMI</b></p>	<p><b>HDMI (eARC)</b></p>	 <p>HDMI (eARC)</p> <p>HDMI cable (not included)</p> <p>Audio Amplifier/Speaker</p>
	<p><b>HDMI</b></p>	 <p>HDMI</p> <p>HDMI cable (not included)</p> <p>DVD/Blu-Ray/AV receiver/ Set-top Box</p>
<p><b>AV IN</b></p>		 <p>Red(R)</p> <p>White(L)</p> <p>Yellow(Video)</p> <p>AV IN</p> <p>(Cables are not included)</p> <p>VCR/DVD Player/ Recorder/Set-top box/ Satellite Receiver/ Video Camera</p>
<p><b>HEADPHONE</b></p>		 <p>Headphone (not included)</p> <p><b>NOTE</b></p> <ul style="list-style-type: none"> <li>Excessive sound pressure from earphones and headphones can cause hearing loss.</li> </ul>

## Making Connections

### COMMON INTERFACE



#### NOTES

- Before you insert/remove the CI+ module, ensure that the TV is switched off. Then insert the CI card into the CI+ module in accordance with the Service Provider's instructions.
- Do not repeatedly insert or remove the Common Access Module as this may damage the interface and cause a malfunction.
- You must obtain a CI+ module and card from the service provider of the channels you want to watch.
- Insert the CI+ module with the SmartCard in the direction marked on the module and SmartCard.
- CI+ is not supported in some countries and regions; check with your authorized dealer.

### USB



#### NOTES

- When connecting a hard disk or a USB hub, always connect the mains adapter of the connected device to the power supply. Exceeding a total current consumption may result in damage. The USB 1.1 and USB 2.0 devices maximum current consumption are 500mA. The USB 3.0 device maximum current consumption is 1A.
- For individual non-standard high-capacity mobile hard disk, if its impulse current is greater than or equal 1A, it may cause TV-rebooting or self-locking. So the TV does not support it.
- The USB port supports a voltage of 5V.

## Remote Control

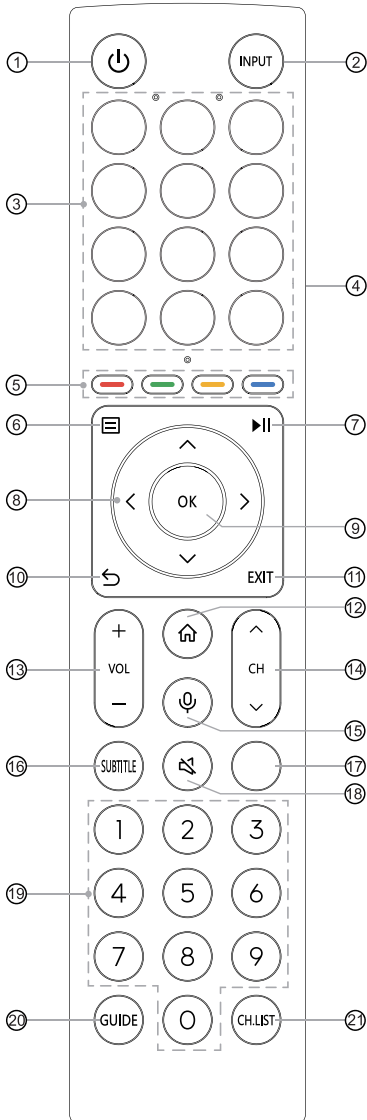

- ① POWER: Switch the TV on or into standby mode
- ② INPUT: Select input sources
- ③ APP: Quick access buttons to apps  
EDIT: Custom to launch input or app
- ④ Physical Switch (Side view): Turn on to activate hands-free wake-up feature\*
- ⑤ Special function buttons
- ⑥ : Display the Quick setup menu
- ⑦ : Media content control function button
- ⑧ : Allow you to navigate the on-screen menus and adjust the system settings to your preference
- ⑨ OK: Confirm the selection in the on-screen menus
- ⑩ BACK: Return to previous menu
- ⑪ EXIT: Exit the menu
- ⑫ HOME: Enter the Home screen
- ⑬ VOL + / -: Adjust the volume
- ⑭ CH ^ / v : Switch channel
- ⑮ MIC: Activate the microphone
- ⑯ SUBTITLE: Activate or deactivate the subtitle mode
- ⑰ INFO: Display the present programme information  
TEXT: Turn on/off the teletext function
- ⑱ MUTE: Mute or restore the TV sound
- ⑲ Number buttons: Direct channel selection or numbers input
- ⑳ GUIDE: Display the Electronic Programme Guide (DTV mode)
- ㉑ CH.LIST: Display the Channel List on the screen

\*When you do not use hands-free wake-up, please turn off the physical switch to lengthen the battery life.

**NOTE:** The included remote control will vary depending on model, countries/regions. Check information according to the actual remote control in the accessory bag.

# Remote Control

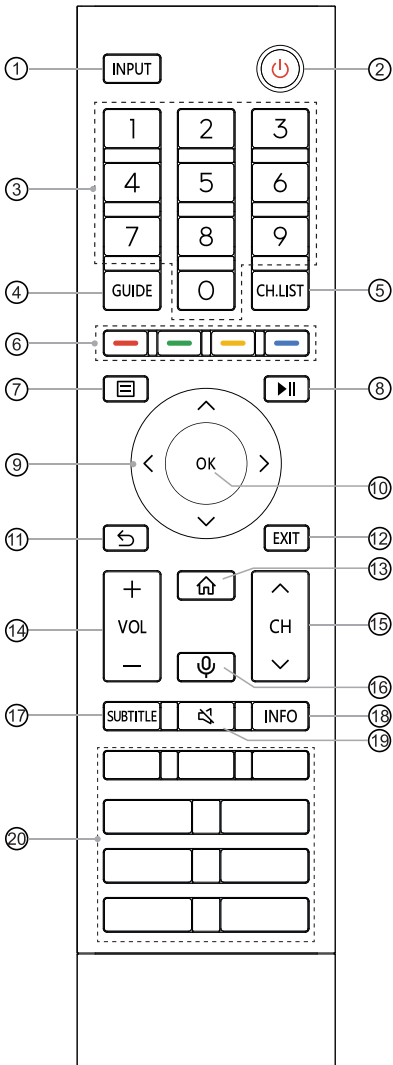

- ① INPUT: Select input sources
- ② POWER: Switch the TV on or into standby mode
- ③ Number buttons: Direct channel selection or numbers input
- ④ GUIDE: Display the Electronic Programme Guide (DTV mode)
- ⑤ CH.LIST: Display the Channel List on the screen
- ⑥ Special function buttons
- ⑦ : Display the Quick setup menu
- ⑧ : Media content control function button
- ⑨ : Allow you to navigate the on-screen menus and adjust the system settings to your preference
- ⑩ OK: Confirm the selection in the on-screen menus
- ⑪ BACK: Return to previous menu
- ⑫ EXIT: Exit the menu
- ⑬ HOME: Enter the Home screen
- ⑭ VOL + / -: Adjust the volume
- ⑮ CH / : Switch channel
- ⑯ MIC: Activate the microphone
- ⑰ SUBTITLE: Activate or deactivate the subtitle mode
- ⑱ INFO: Display the present programme information
- ⑳ MUTE: Mute or restore the TV sound
- ㉑ APP: Quick access to the app
- ㉒ MEDIA: Enter the media mode
- ㉓ : All Apps
- ㉔ BROWSER: Enter into BROWSER

**NOTE:** The included remote control will vary depending on model, countries/regions. Check information according to the actual remote control in the accessory bag.

## Remote Control

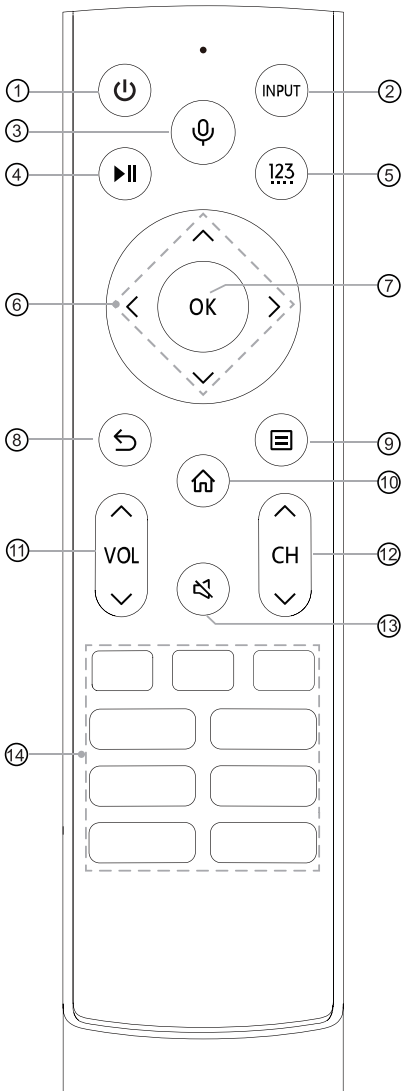

- ① : Switch the TV on or into standby mode
- ② INPUT: Select input sources
- ③ : Activate the microphone
- ④ : Media content control function button
- ⑤ 123: Enter Channels / input numbers and special function buttons (Red/Green/Yellow/Blue)
- ⑥ : Allow you to navigate the on-screen menus and adjust the system settings to your preference
- ⑦ OK: Confirm the selection in the on-screen menus
- ⑧ : Return to previous menu
- ⑨ : Display the Quick setup menu
- ⑩ : Enter the Home screen
- ⑪ VOL : Adjust the volume
- ⑫ CH : Switch channel
- ⑬ : Mute and restore sound
- ⑭ APP: Quick access buttons to apps  
MEDIA: Enter the media mode

**NOTE:** The included remote control will vary depending on model, countries/regions. Check information according to the actual remote control in the accessory bag.



## Remote Control

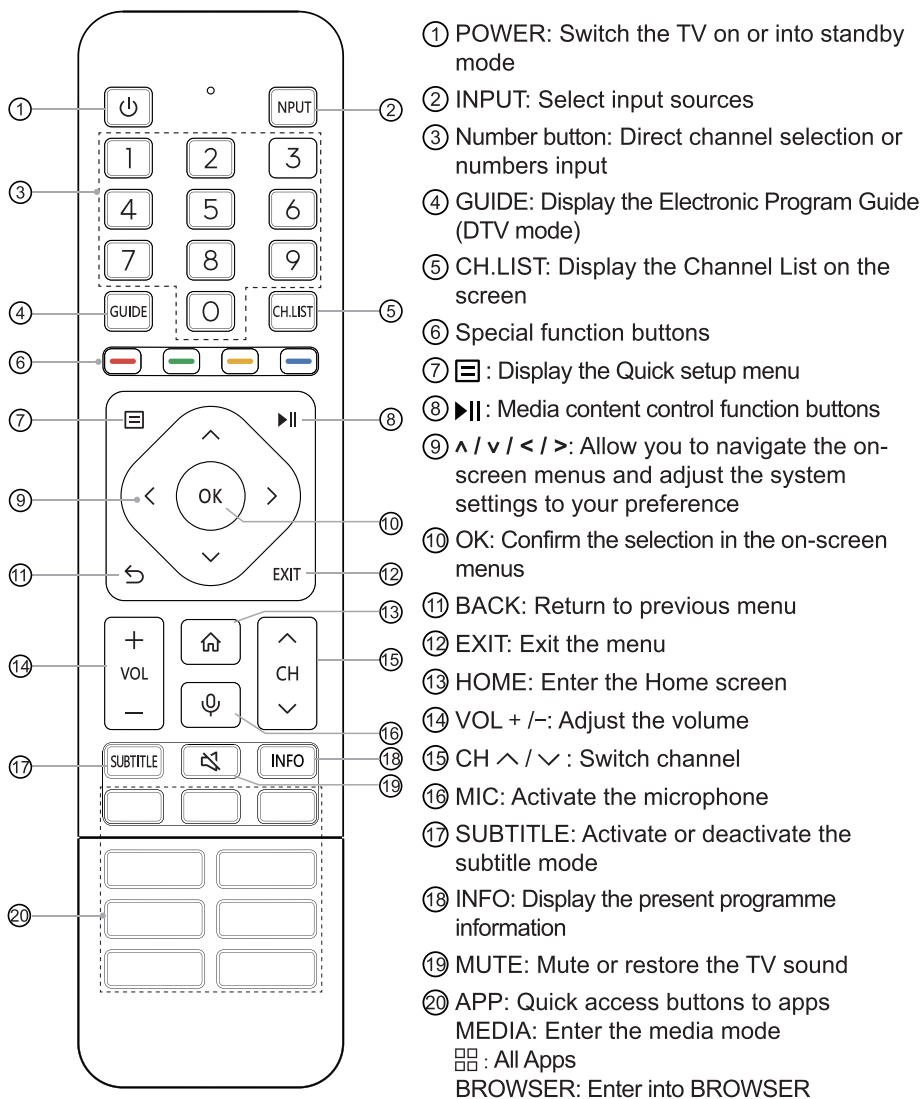

**NOTE:** The included remote control will vary depending on model, countries/regions. Check information according to the actual remote control in the accessory bag.

## Remote Control

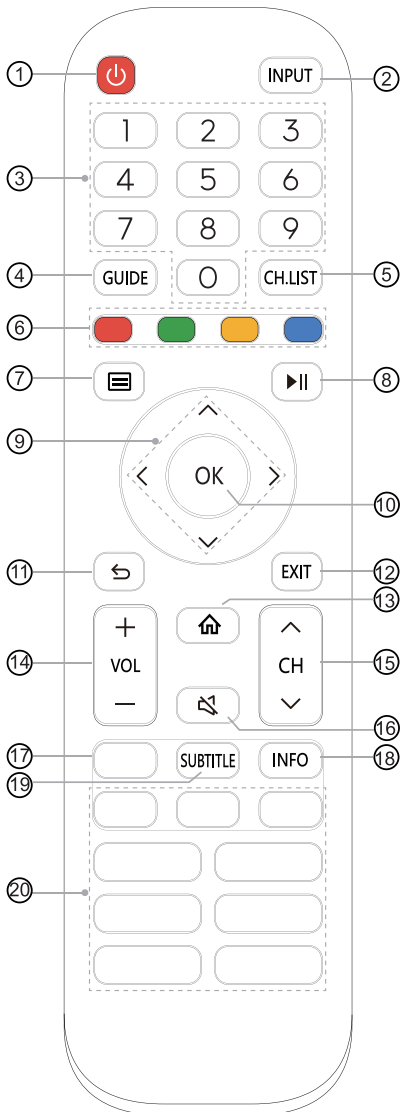

- ① POWER: Switch the TV on or into standby mode
- ② INPUT: Select input sources
- ③ Number buttons: Direct channel selection or numbers input
- ④ GUIDE: Display the Electronic Programme Guide (DTV mode)
- ⑤ CH.List: Display the Channel List on the screen
- ⑥ Special function buttons
- ⑦ : Display the Quick setup menu
- ⑧ : Media content control function buttons
- ⑨ : Allow you to navigate the on-screen menus and adjust the system settings to your preference
- ⑩ OK: Confirm the selection in the on-screen menus
- ⑪ BACK: Return to previous menu
- ⑫ EXIT: Exit the menu
- ⑬ HOME: Enter the Home screen
- ⑭ VOL + / -: Adjust the volume
- ⑮ CH ^ / v: Switch channel
- ⑯ MUTE: Mute or restore the TV sound
- ⑰ TXT/TEXT: Turn on/off the teletext function
- ⑱ INFO: Display the present programme information
- ⑲ SUBTITLE: Activate or deactivate the subtitle mode
- ⑳ APP: Quick access buttons to apps  
MEDIA: Enter the media mode

**NOTE:** The included remote control will vary depending on model, countries/regions. Check information according to the actual remote control in the accessory bag.

## Remote Control

### ► Installing Batteries in the Remote Control

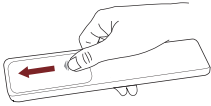

1. Slide the back cover to open the battery compartment of the remote control.

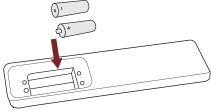

2. Insert two AA or AAA size batteries. Make sure to match the (+) and (-) ends of the batteries with the (+) and (-) ends indicated in the battery compartment.

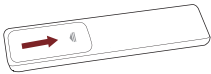

3. Close the battery compartment with the cover.

### ☒ NOTES

- Product image is only for reference, actual product may vary in appearance.

#### Handling the Batteries

- Incorrect use of batteries may cause corrosion or battery leakage, which could cause fire, personal injury or damage to property.
- Only use the battery type indicated in this manual. Whether to use AA or AAA size batteries, please refer to the actual remote control.
- Do not mix old and new batteries or different types of batteries.
- Do not dispose of used batteries as domestic waste. Dispose of them in accordance with local regulations.

### ► Pairing the Remote Control (only for Bluetooth remote control)

Pair the remote to the TV after you power it on. Keep the remote control within 3 metres from the TV. Press any button (except power and mic button) to pair.

### ☒ NOTES

- In special cases, press and hold [  ] button to pair.
- If an unknown error occurred with the remote, then it could have been caused by interference. Try to remove what's causing the interference and pair it again.
- If an unknown error occurred in the remote control while the battery power is normal, you can take out the batteries, press any key for 1~2 seconds, and insert them back. Then the remote control will work normally.
- The remote cannot be paired to the TV while the TV is in standby mode.

### ► Remote Control Operation Range

1. The remote control can work at a distance of up to 8 metres in front of the TV set.
2. The remote control angle: taking the remote sensor as an apex, 6 metres away, its controlled horizontal angle is within  $\pm 30^\circ$ , while the vertical angle is within  $\pm 15^\circ$ .
3. The operating distance may vary depending on the brightness of the room.

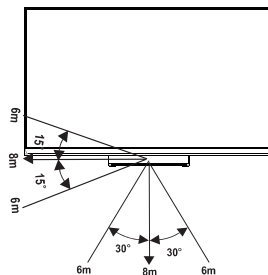

### Disposal of this unit

Product should not be damaged, dismantled or thrown in municipal waste. It should be packed and handed over to authorised re-cycler.

## Turning the TV on for the First Time

### Turning the TV on for the First Time

1. Connect the mains cable to the mains socket after you have completed all the connections.
2. The first time you turn the TV on, it will go straight into the Installation Guide.
3. Press the [  $\wedge$  /  $\vee$  /  $<$  /  $>$  ] buttons to navigate the menu and change the settings. Press the [OK] button to confirm.

<b>Select your Language</b>	Select your desired language to be displayed on the menu. Press menu button to set up your TV for store mode.
<b>Set up on Mobile or Set up on TV</b>	Set up with the smart device by scanning the QR code to download the mobile app, or continue on TV.
<b>Connect to the Internet</b>	Connect you to your favourite apps, movies, and programmes on the Internet through WLAN.
<b>Select your Location</b>	Knowing your location will help us tailor recommended contents for you.
<b>Terms &amp; Conditions, Privacy Policy</b>	Your use of this device is subject to the End User License Agreement, and lack of your acceptance of the End User License Agreement will turn off all smart features of this device. Please read the details carefully before you choose.
<b>Sign in to your VIDAA Account</b>	With a VIDAA account, you can manage your content preferences, subscriptions and more.
<b>Select your Voice Assistant</b>	Select your voice assistant you want to use on the TV.
<b>Name your TV</b>	Give your TV a unique name to help identify it when casting or connecting to it from other devices.
<b>Welcome to VIDAA</b>	Congratulations, you have finished the set-up. Choose from the selections on screen to get started according to your preferences.

**NOTE:** The Guide above is for referencing purpose and may differ depending on models/countries/regions.

## Specifications

☑ Features, appearance and specifications are subject to change without notice.

Item		55"	65"
Dimension (W × H × D)	Without Stand	48.5 × 28.9 × 3.0 inches (1233 × 734 × 77 mm)	57.2 × 33.8 × 3.1 inches (1452 × 858 × 78 mm)
	With Stand	48.5 × 30.9 × 11.8 inches (1233 × 784 × 300 mm)	57.2 × 36.0 × 11.8 inches (1452 × 914 × 300 mm)
Weight	Without Stand	42.8 lbs (19.4 kg)	58.4 lbs (26.5 kg)
	With Stand	54.0 lbs (24.5 kg)	69.4 lbs (31.5 kg)
Active Screen Size (Diagonal)		139 cm	164 cm
Screen resolution		3840 × 2160	
Audio power		4×10W+20W+2×5W	4×10W+20W+2×5W
Operating mode power density		0.028 Watts/cm <sup>2</sup>	0.025 Watts/cm <sup>2</sup>
Power consumption when turned off		N.A.	
Power consumption in standby mode		0.5 W	
Power consumption		Please refer to the rating label.	
Power supply		Please refer to the rating label.	
Receiving systems	Analogue	PAL-D/K, B/G, I, SECAM-D/K, B/G	
	Digital	DVB-T/T2, DVB-C, DVB-S/S2	
Environmental conditions		Temperature: 5°C - 45°C Humidity: 20% - 80% RH Atmospheric pressure: 86 kPa - 106 kPa	
HDMI Input		RGB / 60Hz (640×480, 800×600, 1024×768) YUV / 60Hz (480i, 480p, 720p, 1080i, 1080p) YUV / 50Hz (576i, 576p, 720p, 1080i, 1080p) 3840×2160 / 24Hz, 3840×2160 / 25Hz, 3840×2160 / 30Hz, 3840×2160 / 50Hz, 3840×2160 / 60Hz For HDMI 3, 4: 3840×2160 / 120Hz, 2560×1440 / 120Hz, 1920×1080 / 120Hz	

## Other Information



The terms HDMI and HDMI High-Definition Multimedia Interface, and the HDMI Logo are trademarks or registered trademarks of HDMI Licensing Administrator, Inc. in the United States and other countries.



Dolby, Dolby Vision, Dolby Atmos, and the double-D symbol are registered trademarks of Dolby Laboratories Licensing Corporation. Dolby Vision IQ is a trademark of Dolby Laboratories Licensing Corporation. Manufactured under license from Dolby Laboratories. Confidential unpublished works. Copyright © 2012-2021 Dolby Laboratories. All rights reserved.



For DTS patents, see <http://patents.dts.com>. Manufactured under license from DTS Licensing Limited. DTS, DTS-HD Master Audio, DTS-HD, Virtual:X, and the DTS-HD logo are registered trademarks or trademarks of DTS, Inc. in the United States and other countries. © 2021 DTS, Inc. ALL RIGHTS RESERVED.



Manufactured under license from IMAX Corporation. IMAX® is a registered trademark of IMAX Corporation in the United States and/or other countries. For DTS patents, see <http://patents.dts.com>. Manufactured under license from DTS Licensing Limited. DTS and the DTS logo are registered trademarks or trademarks of DTS, Inc. in the United States and other countries. © 2020 DTS, Inc. ALL RIGHTS RESERVED.