

Thank you for your trust and for buying this appliance. We hope it will successfully serve the purpose for many years.

The appliance is intended solely for household use.

Refrigerator is for domestic use only and is intended for storing fresh foods at the temperature higher than 0°C.

Before Putting Into Use.....	11	Operation Control	15
Instructions for Use		Temperature Selection	
We Care for the Environment		Use.....	15
Tips for Energy Savings		Storing Fresh Foods	
Important	12	Maintenance and Cleaning	16
Disposing of the Worn Out Appliance		Automatic Defrosting of the Refrigerator	
Placing and Installation	13	Cleaning the Appliance	
Choosing the Right Place		Switch Off the Appliance When Not In Use	
Connection to Power Supply		Trouble-Shooting Guide.....	17
Description of the Appliance	14		

i Before Putting Into Use

- Before connecting the appliance to the mains supply, leave it stand for about 2 hours, which will reduce a possibility of malfunctions in the cooling system due to transport handling.
- Clean the appliance, and be thorough, especially in the interior (See Cleaning and Maintenance).
- In case the interior accessories are not correctly placed, rearrange them as described in chapter Description of the Appliance.

Instructions for Use

These instructions for use are intended for the user. They describe the appliance and its correct and safe use. They were prepared for various types/models of refrigerators therefore you might find in it description of some functions and accessories that your appliance does not have.

We Care for the Environment

- Our appliances are distributed in packaging made of environmental friendly material which could safely be recycled, disposed off

or destroyed, with no effects on the nature whatsoever.

- These instructions are printed either on recycled paper or chlorine free bleached paper.
- When your appliance finally wears out, please try not to burden the environment with it; call your nearest authorised service agent. (See Disposing of the Worn Out Appliance).

Tips for Energy Savings

- Try not to open the door too often, especially when the weather is wet and hot. Once you open the door, mind to close it as soon as possible. This is especially important if you have an upright model.
- Every now and then check if the appliance is sufficiently ventilated (adequate air circulation behind the appliance).
- Turn the thermostat knob from higher to lower setting as soon as possible (depends on how loaded the appliance is, ambient temperature...).

- Before loading the appliance with fresh food, make sure it was cooled to ambient temperature.
- Ice and frost layer increase energy consumption, so do clean the appliance as soon as the layer is 3-5 mm thick.
- If the gasket is damaged or if it turns out that the sealing is poor, the energy consumption is substantially higher. To restore efficiency, replace the gasket.
- The condenser on the rear wall should be always clean, free of dust or any impurities.
- Always consider instructions stated in sections Positioning and Energy Saving Tips, otherwise the energy consumption is substantially higher.

Important

- This appliance can be used by children aged from 8 years and above and persons with reduced physical, sensory or mental capabilities or lack of experience and knowledge if they have been given supervision or instruction concerning use of the appliance in a safe way and understand the hazards involved. Children shall not play with the appliance. Cleaning and user maintenance shall not be made by children without supervision.
 - If you have bought this appliance to replace an old one equipped with a lock that cannot be opened from inside (lock, bolt), make sure that the lock is broken. This will make it impossible for children to lock themselves inside the appliance and suffocate.
 - The appliance must be correctly connected to the mains supply. (see: Connecting to the Mains Supply).
 - If the food has strange smell or color, throw it away, because it is very likely that it is spoiled and therefore dangerous to eat.
 - Shear-type hinge (only on some models) enables automatic door closing at the opening angle of 20°. On account of strong springs take care when handling the door.
 - The bag with instructions also contains squares and sponges, intended for installation of integrated appliance with shear-type hinge, as well as plastic caps for covering of hollow spots on walls inside the appliance.
 - Disconnect the appliance from the power supply before repairing it (only a qualified technician should repair it), before cleaning and before replacing the light bulb.
 - Do not defrost the appliance with other electric appliances (as for example with hair dryer) and never scrape the frost layer with sharp objects. Use only enclosed tools or tools recommended by the manufacturer.
 - For the sake of environment protection - be careful not to damage the rear wall of the appliance (the condenser unit or the tubes - for example when moving the appliance) or any part of the refrigerating system inside the appliance. Do not use sharp object for defrosting the appliance.
 - The refrigerating system of the appliance is filled with refrigerant and oil, so when the appliance is damaged, handle it with care and dispose it of in compliance with environmental protecting precautions. (See We Care for the Environment).
 - If the supply cord is damaged, it must be replaced by the manufacturer or his service agent or a qualified person in order to avoid hazard.
 - The rating plate is inside the appliance or outside on the rear wall.
- **Warning! Ventilation slots on the appliance or a built-in element must always be clean and unobstructed.**
 - **Warning! Do not use mechanical devices or tools to defrost the refrigerator, nor any other methods except for those**

recommended by the manufacturer.

- **Warning!** When installing, cleaning, or removing the appliance, make sure the insulation on the refrigeration system parts is not damaged. Thus you will also prevent damage to the environment.
- **Warning!** Do not use electric appliances in the refrigerator or freezer interior, except for those expressly allowed by the

refrigerator-freezer manufacturer.



The symbol on the product or on its packaging indicates that this product may not be treated as household waste. Instead it shall be handed over to the applicable collection point for the recycling of electrical and electronic equipment. By ensuring this product is disposed of correctly, you will help prevent potential negative consequences for the environment and human health, which could otherwise be caused by inappropriate waste handling of this product. For more detailed information about recycling of this product, please contact your local city office, your household waste disposal service or the shop where you purchased the product.

Disposing of the Worn Out Appliance

- When your appliance finally wears out, dispose of it. If the appliance has a lock, break it, in order to prevent eventual accidents (danger of children get locked inside the appliance).
- The refrigerating system of the appliance is filled with refrigerant and insulating substances which should be separately treated and processed. Call your nearest authorised service agent or specialised servicing centre. If you don't find one, contact your local authorities or your distributor. Be careful not to damage the tubes on the rear wall of the appliance (danger of pollution).

Placing and Installation

Choosing the Right Place

Place the appliance in a dry and regularly ventilated room. Allowed ambient temperature depends on the model (class) of the appliance and is stated on the rating plate of the appliance. Never place the appliance near heat emitting devices (e.g. cooker, radiator, water heater or similar devices) and do not expose it to direct sunlight. The appliance should be positioned at least 3 cm away from the electric or gas cooker and at least 30 cm away from the oil or coal stove. If this is not possible, use an appropriate insulation. Behind the appliance

there should be free space at least 200 cm² wide and above the appliance the high kitchen units should be at least 5 cm away from the appliance in order to assure adequate ventilation of the condenser unit.

Class	Ambient temperature
SN (subnormal)	from + 10°C to + 32°C
N (normal)	from + 16°C to + 32°C
ST (sub-tropical)	from + 16°C to + 38°C
T (tropical)	from + 16°C to + 43°C

Connection to Power Supply

Connect the appliance with the cable and plug to the power supply socket outlet with a ground terminal (safety socket). Required nominal voltage and frequency are indicated on the

rating plate. The connection to the mains supply and earthing have to be made according to current standards and regulations. The appliance resists temporary voltage tolerance up to -6 to +6 %

Description of the Appliance

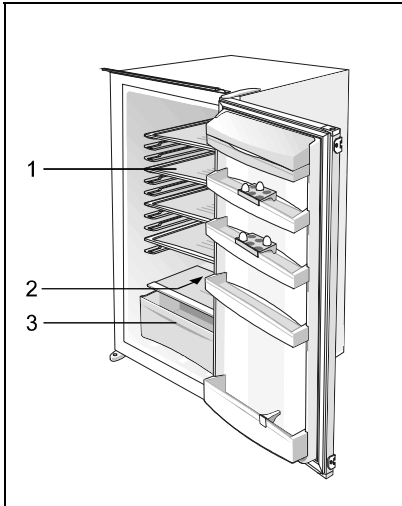

Shelf (1)

It applies to the appliances using sliding technics (number depends on the model)
Shelf can be optionally placed on the guides inside the appliance. It is protected against pulling out. If you want to remove it, slightly lift up the back part and pull it out. Glass shelves (some models only have them) are protected with plastic spacers. Before pulling the shelf out, spacers must be moved towards you. Spacers can be also removed, however, it is better to keep them for any later transport. Quickly perishable food should be stored on the back i.e. the coldest part of the shelves.

Bottle support

(in some models only)
Bottle support (number depends on model) is intended for bottle keeping. It is protected against pulling out and so you can remove only empty one by lifting up the front end and pull it toward you. At appliances with shear-type hinge lift it in the front part and pull it out towards yourself.

Warning!

If the door contains storing shelves, install the rack in such position that the length of the bottles will not hinder the closing of the door.

The rack may carry 9 bottles of 0,75 l or more at the maximum (total weight max. 13 kg)– note the label underneath the thermostat box inside the appliance.

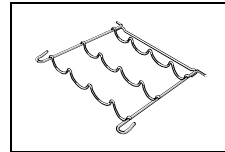

Defrost Water Outlet (2)

The interior of the refrigerator is cooled with cooling plate incorporated in the rear wall. Under the plate there is a channel and an outlet for defrost water. Regularly check the defrost water outlet and the channel, because they should never be clogged (as for example with food rests). If clogged, use a plastic straw and clean it.

Fruit and Vegetable Container (3)

The container is on the bottom of the appliance under the glass shelf. It provides adequate humidity which has favourable effect on fruit and vegetables stored in it (less dehydration).

Door Liner

The door liner consists of various shelves or holders used for storing eggs, cheese, butter and yogurt as well as other smaller packages, tubes, cans etc. The lower shelf is used for storing bottles.

Illumination in the Interior of the Refrigerator

The light for illuminating the interior of the appliance is on, when the door is opened. The operation of the light does not depend on the position of the thermostat knob.

NOTE:

- The appliance can be equipped with various accessories, depending on the model of the appliance.

- Various accessories (spice container, tube holder or additional shelves) can be bought in

authorized centres

Operation Control

The appliance is controlled with thermostat knob, situated in the right upper part inside the appliance. Turn the knob from **STOP** position towards **7** and backwards.

Temperature Selection

- Higher settings on the knob (towards **7**) mean lower temperatures (colder) in all three compartments of the appliance. Temperature in the interior of the appliance may even drop below 0°C. Higher settings should be used only in case higher temperature is recommended or required. When the ambient temperature is normal, we recommend medium setting.
- Changes of the ambient temperature affect temperature in the interior of the appliance (choose correct setting of the thermostat knob).

- In **STOP** position the appliance does not operate (the cooling system is switched off), yet power supply is not interrupted (the light is on, when you open the refrigerator door).
- Temperature in the refrigerator also depends on how often the door is opened.

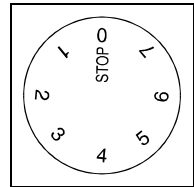
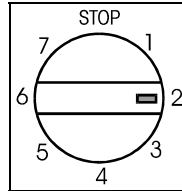

Use

Storing Fresh Foods

Proper use of the appliance, adequately packed food, correct temperature and taking into account hygienic precautions will substantially influence the quality of the food stored.

- Foods to be stored in the refrigerator should be properly packed as to prevent mixing various moisture degrees and odors (in polyethylene bags or sheet, aluminium foil, wax paper, or stored in covered containers or bottles).
- Before storing food in the refrigerator, remove the excessive packaging (like yoghurt in multi-package).
- Pack systematically and make sure that foodstuffs do not touch each other (various odours may mix). Assure adequate air circulation around packages.
- Never store inflammable, volatile or explosive substances.
- Beverages with high alcohol percentage shall be stored in tightly sealed bottles in vertical position.
- Food should not touch the rear wall of the refrigerator!
- Foods should be cooled down before storing.
- Crispy and delicate foods should be stored in the coldest parts of the refrigerator.
- Try not to open the door too often.
- Set the thermostat to the setting where lowest temperatures are reached. Set the thermostat gradually as to avoid freezing of the foods. Use a thermometer and measure the temperature in the individual compartments. Place the thermostat in a glass vessel filled with water. Temperature readings are most reliable few hour after steady state is reached.
- Some organic solutions like volatile oils in lemon and orange peel, acid in butter etc. can cause damages when in contact with plastic surfaces or gaskets for longer period of time.
- Unpleasant odor inside the refrigerator is a sign that something is wrong with foods or that your refrigerator needs cleaning. Unpleasant odor can be eliminated or reduced by washing the interior of the refrigerator with a mild solution of water and vinegar. We also recommend using activated carbon filters to clean the air or to neutralize odors.
- If you plan a longer journey, make sure to remove quickly perishable articles of food out of the appliance before you leave.

Fresh Food Storage Time in the Refrigerator

Article of food	Storage time (days)													
	1	2	3	4	5	6	7	8	9	10	11	12	13	14
Butter	+	+	+	+	+	+	+	=	=	=	=	=		
Eggs	+	+	+	+	+	+	+	+	+	+	=	=	=	=
Meat: fresh uncut chopped smoked	+	+	=											
	+	=												
	+	+	+	+	+	+	+	+	+	+	=	=	=	=
Fish	+	=												
Marinade	+	+	+	+	+	+	+	+	+	+	=	=	=	=
Root	+	+	+	+	+	+	+	+	=	=	=	=	=	=
Cheese	+	+	+	+	=	=	=	=	=	=	=	=	=	=
Sweets	+	+	=	=	=	=								
Fruit	+	+	=	=	=	=	=	=	=	=				
Prepared dishes	+	+	=	=										

Legend:

+ recommended storage time

= possible storage time

Maintenance and Cleaning

Automatic Defrosting of the Refrigerator

There is no need to defrost the refrigerator, because ice depositing on the inner back wall is defrosted automatically. Ice is depositing on the inner back wall during the compressor operation; later on, when the compressor is not operating ice is defrosting and water drops collect and drain through the outlet in the inner back wall into the drain pan situated above the compressor, from where it evaporates.

Cleaning the Appliance

Disconnect the power supply before cleaning the appliance.

Do not use coarse or aggressive cleaning agents as you can damage the surface. Be careful to remove any cleanser agent remaining after cleaning.

- Clean the **exterior** with water and detergent. Varnished surfaces are cleaned with soft cloth and an alcohol based cleaning agent (for example glass cleaners). You may also use alcohol (ethanol or isopropyl alcohol). The application of abrasive and specially aggressive cleaners, such as the stainless steel cleaners, is not appropriate for the cleaning of plastic and coated parts.
- Remove the **detachable accessories** in the interior of the appliance and clean it with water and liquid detergent. Plastic parts cannot be washed in washing machine.

- Wash the **interior** of the appliance with lukewarm water, in which you added one or two spoonfuls of vinegar.
- Every now and then wipe the **condenser** on the rear wall. Use soft non-metal brush or vacuum cleaner.

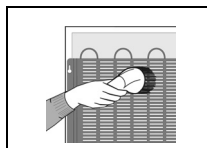

- Do not forget to clean also the defrost water **receptacle** above the refrigerator compressor (do not remove the receptacle).

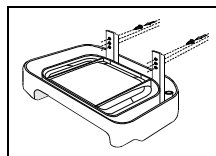

After cleaning, connect the appliance to power supply and reload it.

Switch Off the Appliance When Not In Use

If you do not intend to use the appliance for a longer period, set the thermostat knob to the **STOP (0)** position, disconnect the power

supply, take out the foods and defrost and clean the appliance. Leave the door slightly

open.

❓ Trouble-Shooting Guide

During the service, you can come across some troubles that in most cases result from improper handling of the appliance and can easily be eliminated.

The Appliance Fails to Operate After Connecting to the Mains Supply

- Check the supply in the outlet socket and make sure the appliance is switched on (thermostat knob in operating position).

Continuous Operation of the Refrigerating System

- the door was frequently opened or it was left opened for too long;
- the door is not properly closed (the door may sag, the gasket may be polluted or damaged);
- perhaps you have overloaded the appliance with fresh foods;
- The reason may be inadequate ventilation of the compressor and condenser (assure adequate air circulation and wipe off the condenser);

Ice Formation on the Inner Rear Wall

As long as the defrost water runs to the channel and through the outlet to the drain pan on the compressor, automatic defrosting of the appliance is assured. In case the ice formation on the inner back wall is increased (3-5 mm), ice should be manually defrosted.

Set the thermostat knob to **STOP (0)** position and leave the door open. Never use electric devices for defrosting and do not scrape the ice or frost layer with sharp objects.

After completed defrosting, turn the knob to desired position and close the refrigerator door. The cause of increased ice formation may be one of the following:

- the door does not seal well (clean the gasket if it is contaminated, or replace it if it is damaged);
- the door was frequently opened or it was left opened for too long;
- the food stored in the refrigerator was warm;
- the food or dish is touching the inner back wall.

Water is Leaking From the Refrigerator

In case the discharge water outlet is clogged, or the defrost water drips over the channel, water leaks from the refrigerator.

- Clean the clogged opening, for example with a plastic straw.
- Manually defrost the increased ice layer. See "Ice Formation on the Inner Back Wall".

Noise

Cooling in refrigerating-freezing appliances is enabled by the cooling system with compressor, which produces noise. How noisy the appliance is depends on where it is placed, how it is used and how old the appliance is.

- **During the operation** of the compressor the noise of liquid is heard and when the compressor is not operating, the refrigerant flow is heard. This is a normal condition and it has no influence whatsoever on the lifetime of the appliance.
- **After starting the appliance**, the operation of the compressor and the refrigerant flow may be louder, which does not mean that something is wrong with the appliance and it has no influence on the lifetime of the appliance. Gradually the noise is reduced.
- Sometimes **unusual and stronger noise** is heard, which is rather unusual for the appliance. This noise is often a consequence of inadequate placing.
 - The appliance shall be placed and levelled firmly on solid base.
 - It should not touch the wall or kitchen units standing next to it.
 - Check the accessories in the interior of the appliance, they should be placed correctly in their positions; also check the bottles, tins and other vessels that might touch each other and rattle.

Bulb Replacement

Before replacing the light bulb, disconnect the appliance from the power supply.

Insert the screw driver into the bulb cover opening on the lower side and with slight push downward remove the cover. Replace the old bulb with a new one – halogenous or standard (E 14, max. 25 W - Osram Halolux, Philips H.E.) and fit back the cover.

Don't forget: the old bulb does not belong to organic waste.

Light bulb is consuming good therefore our in-guarantee service does not relate to it.

Bulb lamps used in this appliance are special purpose lamps selected for household appliances use only. They are not suitable for household room illumination.

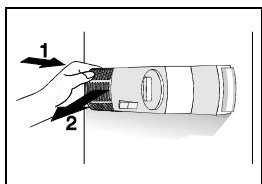
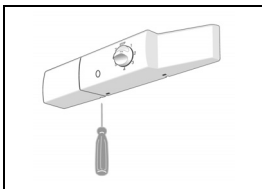

WE RESERVE THE RIGHT TO ALTER THE SPECIFICATIONS WITH NO INFLUENCE ON THE OPERATION OF THE APPLIANCE.

Instructions for use of the appliance can also be found on our website at www.gorenje.com / < <http://www.gorenje.com> />