

# Hisense

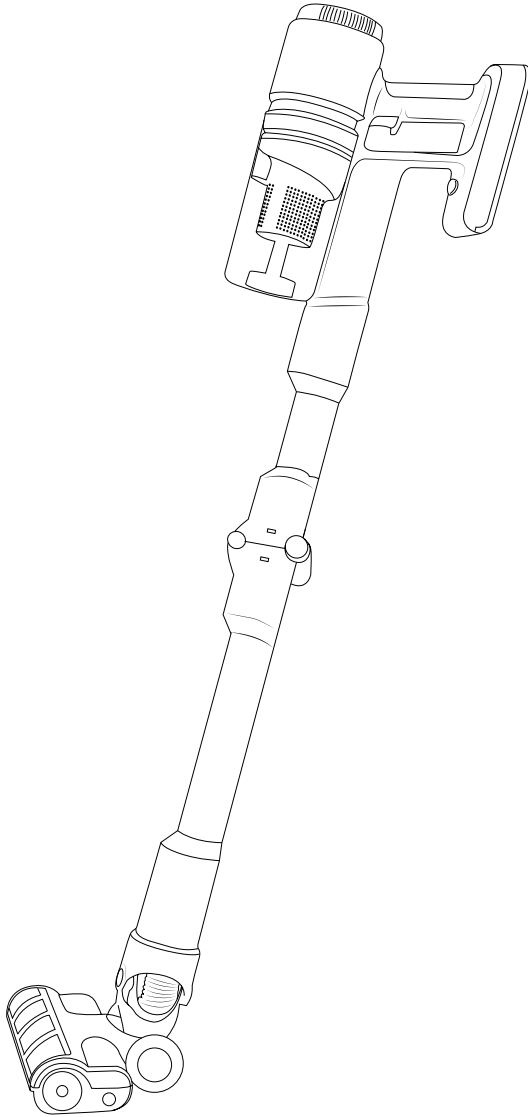

HI-MOVE IV  
HVC6264W

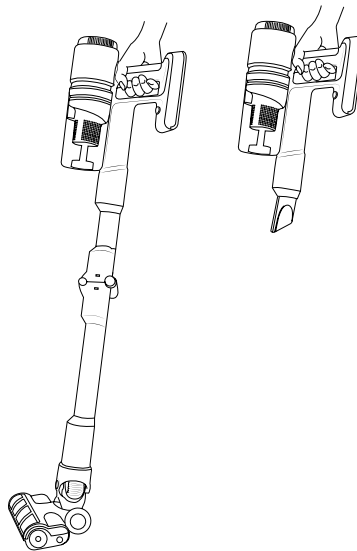

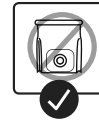
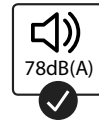
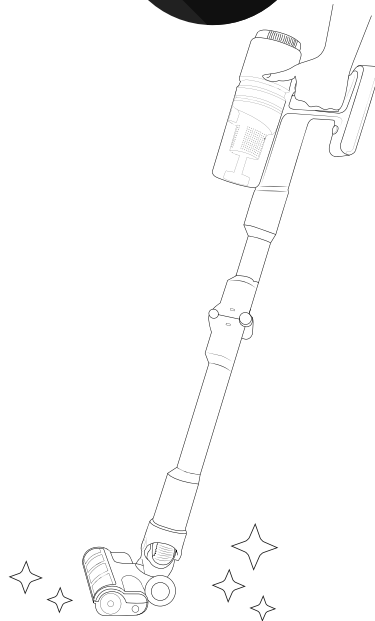

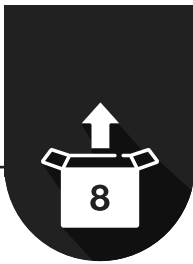

1.

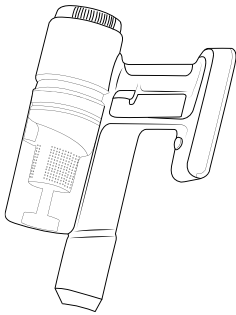

2.

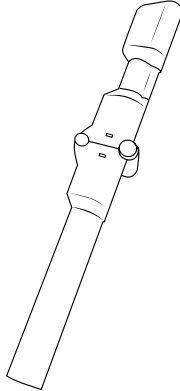

3.

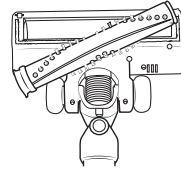

4.



5.



6.

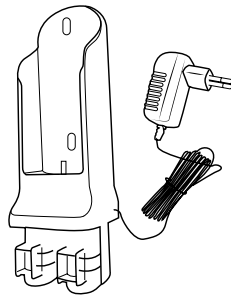

7.

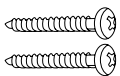

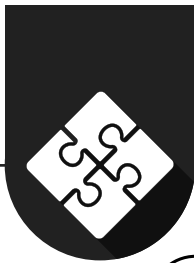

1.

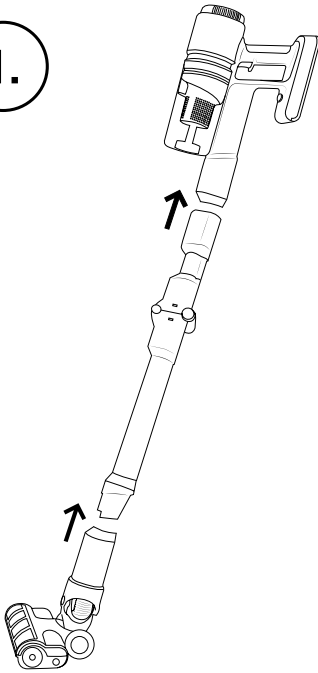

2.

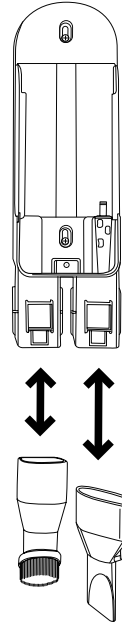

3.

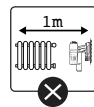
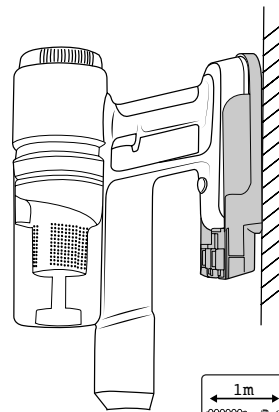
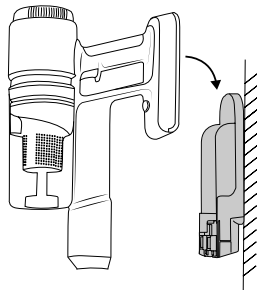
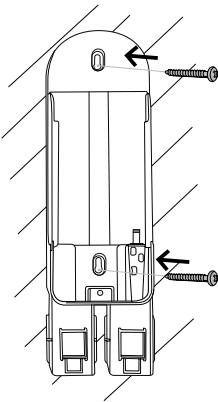



Diagram illustrating the correct and incorrect use of a cordless stick vacuum cleaner. The top section shows two upright configurations, and the bottom section shows a motorized floor head configuration. Each configuration is accompanied by a vertical list of icons indicating surface compatibility.

**Upright Configuration 1 (Left):**

- ✓ Carpet (hatched square)
- ✓ Hardwood floor (floorboard)
- ✗ Laminate floor (floorboard with lines)
- ✗ Wet floor (water drop)

**Upright Configuration 2 (Right):**

- ✓ Hardwood floor (floorboard)
- ✓ Spiderweb (spiderweb)
- ✓ Carpet (hatched square)
- ✓ Flower pot (flower pot)
- ✗ Laminate floor (floorboard with lines)
- ✗ Wet floor (water drop)

**Motorized Floor Head Configuration (Bottom):**

- ✓ Carpet (hatched square)
- ✓ Sofa (sofa)
- ✗ Laminate floor (floorboard with lines)

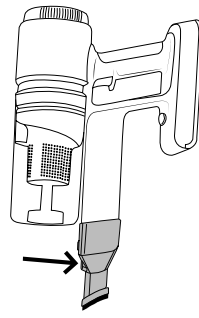
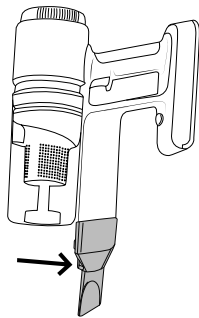
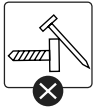
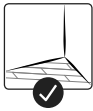
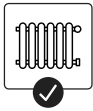
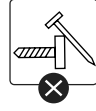
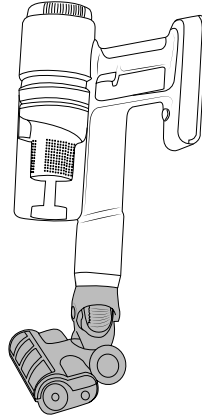
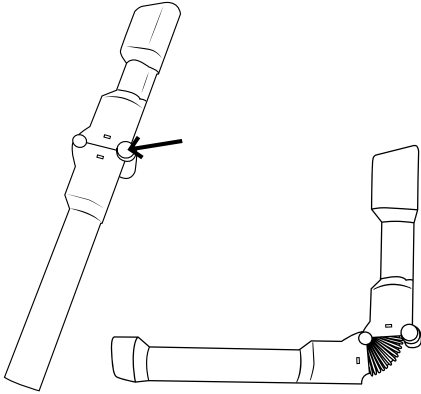



a

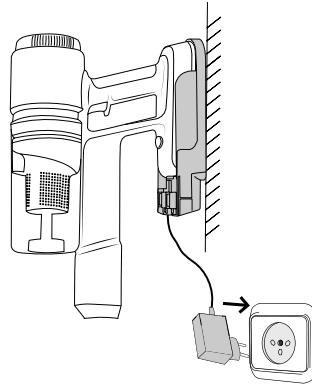

b

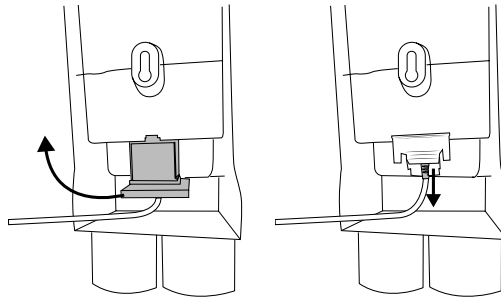
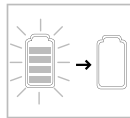
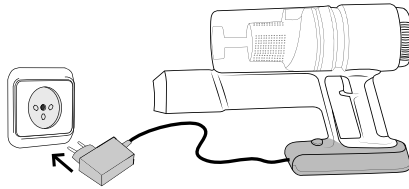

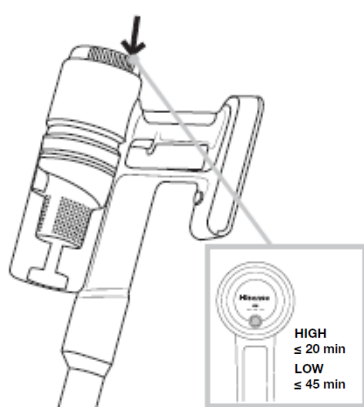
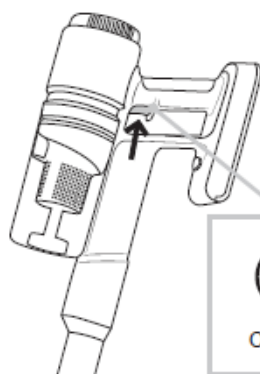
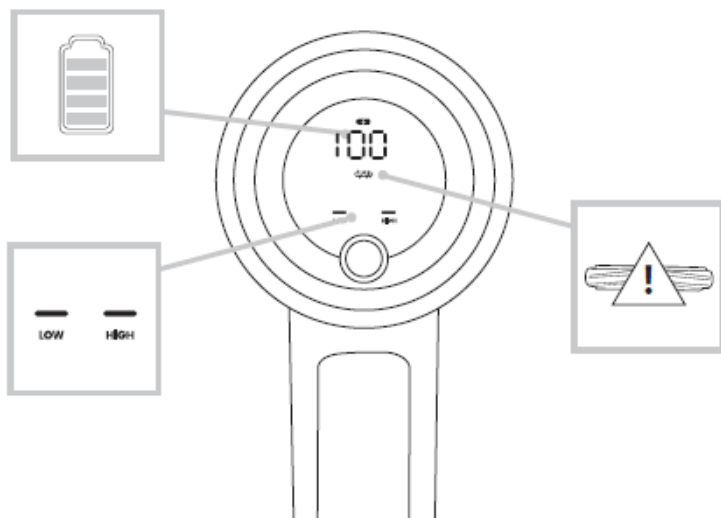



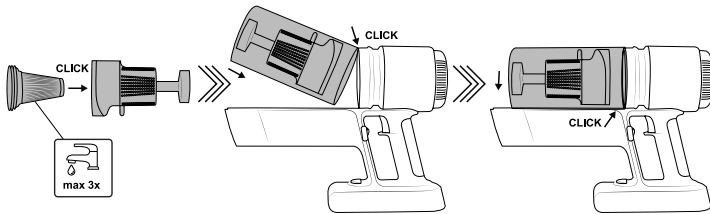
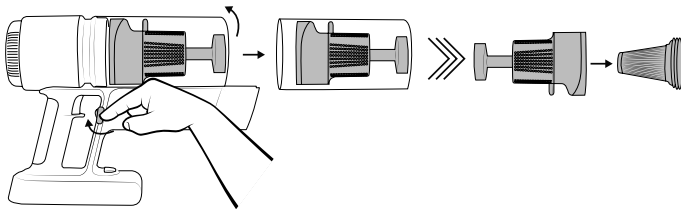
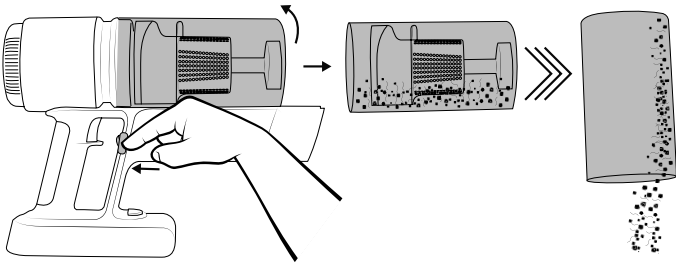

### Filter quick clean

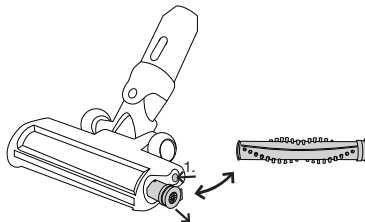
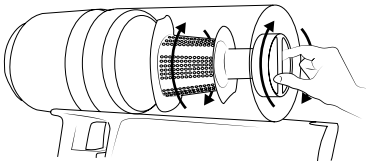

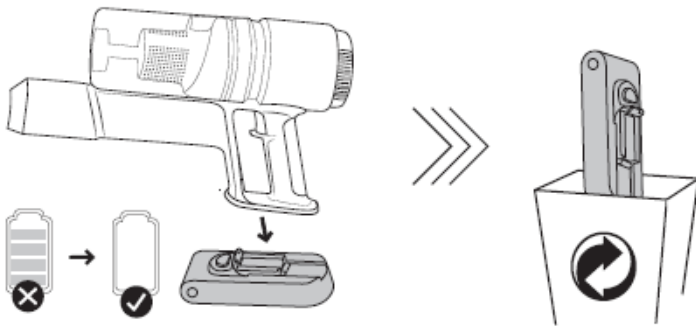
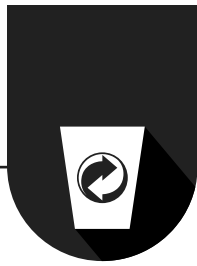



***Hisense***